



| ICAO

Doc 4444

PROCEDURES FOR AIR NAVIGATION SERVICES

Air Traffic Management

Sixteenth Edition, 2016

This edition supersedes, on 10 November 2016, all previous editions of Doc 4444.

INTERNATIONAL CIVIL AVIATION ORGANIZATION

Published in separate English, Arabic, Chinese, French, Russian
and Spanish editions by the
INTERNATIONAL CIVIL AVIATION ORGANIZATION
999 Robert-Bourassa Boulevard, Montréal, Quebec, Canada H3C 5H7

For ordering information and for a complete listing of sales agents
and booksellers, please go to the ICAO website at www.icao.int

Fifteenth edition 2007
Sixteenth edition 2016

Doc 4444, *Procedures for Air Navigation Services — Air Traffic Management*
Order Number: 4444
ISBN 978-92-9258-081-0

© ICAO 2016

All rights reserved. No part of this publication may be reproduced, stored in a
retrieval system or transmitted in any form or by any means, without prior
permission in writing from the International Civil Aviation Organization.

AMENDMENTS

Amendments are announced in the supplements to the *Catalogue of ICAO Publications*; the Catalogue and its supplements are available on the ICAO website at www.icao.int. The space below is provided to keep a record of such amendments.

RECORD OF AMENDMENTS AND CORRIGENDA

AMENDMENTS			
No.	Date applicable	Date entered	Entered by
Amendments 1-7-A incorporated in this edition.			

CORRIGENDA			
No.	Date of issue	Date entered	Entered by

TABLE OF CONTENTS

	<i>Page</i>
FOREWORD	(ix)
CHAPTER 1. Definitions	1-1
CHAPTER 2. ATS safety management	2-1
2.1 General	2-1
2.2 Objectives	2-1
2.3 ATS safety management activities	2-1
2.4 Monitoring of safety levels	2-2
2.5 Safety reviews	2-2
2.6 Safety assessments.....	2-4
2.7 Safety-enhancing measures	2-5
CHAPTER 3. ATS system capacity and air traffic flow management	3-1
3.1 Capacity management	3-1
3.2 Air traffic flow management	3-3
CHAPTER 4. General provisions for air traffic services	4-1
4.1 Responsibility for the provision of air traffic control service.....	4-1
4.2 Responsibility for the provision of flight information service and alerting service.....	4-1
4.3 Division of responsibility for control between air traffic control units	4-2
4.4 Flight plan	4-3
4.5 Air traffic control clearances	4-5
4.6 Horizontal speed control instructions	4-8
4.7 Vertical speed control instructions	4-10
4.8 Change from IFR to VFR flight	4-11
4.9 Wake turbulence categories.....	4-12
4.10 Altimeter setting procedures.....	4-12
4.11 Position reporting	4-14
4.12 Reporting of operational and meteorological information.....	4-18
4.13 Presentation and updating of flight plan and control data	4-21
4.14 Failure or irregularity of systems and equipment	4-22
4.15 Data link communications initiation procedures	4-22
CHAPTER 5. Separation methods and minima	5-1
5.1 Introduction	5-1

5.2	Provisions for the separation of controlled traffic	5-1
5.3	Vertical separation	5-2
5.4	Horizontal separation	5-4
5.5	Separation of aircraft holding in flight	5-39
5.6	Minimum separation between departing aircraft	5-39
5.7	Separation of departing aircraft from arriving aircraft	5-40
5.8	Time-based wake turbulence longitudinal separation minima	5-43
5.9	Clearances to fly maintaining own separation while in visual meteorological conditions	5-48
5.10	Essential traffic information	5-49
5.11	Reduction in separation minima	5-50
CHAPTER 6. Separation in the vicinity of aerodromes		6-1
6.1	Reduction in separation minima in the vicinity of aerodromes	6-1
6.2	Essential local traffic	6-1
6.3	Procedures for departing aircraft	6-1
6.4	Information for departing aircraft	6-5
6.5	Procedures for arriving aircraft	6-5
6.6	Information for arriving aircraft	6-12
6.7	Operations on parallel or near-parallel runways	6-14
CHAPTER 7. Procedures for aerodrome control service		7-1
7.1	Functions of aerodrome control towers	7-1
7.2	Selection of runway-in-use	7-2
7.3	Initial call to aerodrome control tower	7-3
7.4	Information to aircraft by aerodrome control towers	7-3
7.5	Essential information on aerodrome conditions	7-7
7.6	Control of aerodrome traffic	7-8
7.7	Control of traffic in the traffic circuit	7-12
7.8	Order of priority for arriving and departing aircraft	7-13
7.9	Control of departing aircraft	7-13
7.10	Control of arriving aircraft	7-15
7.11	Reduced runway separation minima between aircraft using the same runway	7-16
7.12	Procedures for low visibility operations	7-18
7.13	Suspension of visual flight rules operations	7-20
7.14	Authorization of special VFR flights	7-20
7.15	Aeronautical ground lights	7-20
7.16	Designation of hot spot(s)	7-23
CHAPTER 8. ATS surveillance services		8-1
8.1	ATS surveillance systems capabilities	8-1
8.2	Situation display	8-3
8.3	Communications	8-3
8.4	Provision of ATS surveillance services	8-4
8.5	Use of SSR transponders and ADS-B transmitters	8-4
8.6	General procedures	8-8
8.7	Use of ATS surveillance systems in the air traffic control service	8-15
8.8	Emergencies, hazards and equipment failures	8-21

8.9 Use of ATS surveillance systems in the approach control service	8-24
8.10 Use of ATS surveillance systems in the aerodrome control service	8-31
8.11 Use of ATS surveillance systems in the flight information service	8-32
CHAPTER 9. Flight information service and alerting service.....	9-1
9.1 Flight information service	9-1
9.2 Alerting service	9-5
CHAPTER 10. Coordination	10-1
10.1 Coordination in respect of the provision of air traffic control service.....	10-1
10.2 Coordination in respect of the provision of flight information service and alerting service.....	10-7
10.3 Coordination in respect of the provision of air traffic advisory service	10-7
10.4 Coordination between air traffic services units and aeronautical telecommunication stations.....	10-7
CHAPTER 11. Air traffic services messages	11-1
11.1 Categories of messages.....	11-1
11.2 General provisions	11-3
11.3 Methods of message exchange	11-6
11.4 Message types and their application	11-8
CHAPTER 12. Phraseologies	12-1
12.1 Communications procedures	12-1
12.2 General	12-1
12.3 ATC phraseologies	12-2
12.4 ATS surveillance service phraseologies	12-31
12.5 Automatic dependent surveillance — contract (ADS-C) phraseologies	12-41
12.6 Alerting phraseologies	12-41
12.7 Ground crew/flight crew phraseologies	12-41
CHAPTER 13. Automatic dependent surveillance — contract (ADS-C) services	13-1
13.1 General	13-1
13.2 ADS-C ground system capabilities.....	13-1
13.3 ADS-C-related aeronautical information.....	13-2
13.4 Use of ADS-C in the provision of air traffic control service	13-3
13.5 Use of ADS-C in the application of separation minima	13-10
CHAPTER 14. Controller-pilot data link communications (CPDLC).....	14-1
14.1 General	14-1
14.2 Establishment of CPDLC	14-1
14.3 Exchange of operational CPDLC messages	14-2

CHAPTER 15. Procedures related to emergencies, communication failure and contingencies 15-1

15.1 Emergency procedures 15-1

15.2 Special procedures for in-flight contingencies in oceanic airspace 15-5

15.3 Air-ground communications failure 15-8

15.4 Assistance to VFR flights 15-11

15.5 Other in-flight contingencies 15-12

15.6 ATC contingencies 15-16

15.7 Other ATC contingency procedures 15-18

15.8 Procedures for ATS units when a volcanic ash cloud is reported or forecast 15-21

CHAPTER 16. Miscellaneous procedures 16-1

16.1 Responsibility in regard to military traffic 16-1

16.2 Responsibility in regard to unmanned free balloons 16-1

16.3 Air traffic incident report 16-2

16.4 Use of repetitive flight plans (RPLs) 16-2

16.5 Strategic lateral offset procedures (SLOP) 16-6

16.6 Notification of suspected communicable diseases, or other public health risk, on board an aircraft 16-7

APPENDICES

APPENDIX 1. Instructions for air-reporting by voice communications..... A1-1

APPENDIX 2. Flight plan A2-1

APPENDIX 3. Air traffic services messages A3-1

APPENDIX 4. Air traffic incident report A4-1

APPENDIX 5. Controller-pilot data link communications (CPDLC) message set A5-1

APPENDIX 6. ATS interfacility data communications (AIDC) messages A6-1



FOREWORD

1. Historical background

1.1 The *Procedures for Air Navigation Services — Air Traffic Management* (PANS-ATM) are the result of the progressive evolution of the *Procedures for Air Navigation Services — Air Traffic Control* (PANS-ATC) prepared by the Air Traffic Control Committee of the International Conference on North Atlantic Route Service Organization (Dublin, March 1946).

1.2 A second version of the PANS-ATC was issued in the same year, following review of the original procedures by the International Conference on European-Mediterranean Route Service Organization (Paris, April–May 1946).

1.3 The Third Edition of the PANS-ATC was prepared in 1947 by the Rules of the Air and Air Traffic Control (RAC) Division at its Second Session (Montreal, December 1946–January 1947).

1.4 Originally applicable on a regional basis, the PANS-ATC became applicable on a worldwide basis on 1 February 1950.

1.5 The Fourth Edition (1951) was given the title *Procedures for Air Navigation Services — Rules of the Air and Air Traffic Services* (PANS-RAC) on the recommendation of the Fourth Session of the Rules of the Air and Air Traffic Control (RAC) Division (Montreal, November–December 1950). This title reflected the fact that certain procedures applicable to pilots and a number of procedures relating to the provision of flight information and alerting service were included therein, in addition to the operation of the air traffic control service.

1.6 Further editions were issued periodically. The origin of each edition issued since 1946 and subsequent amendments thereto are shown in Table A, together with a list of the principal subjects involved, the dates on which the amendments were approved by the Council and the dates on which they became applicable.

1.7 This edition, re-titled *Procedures for Air Navigation Services — Air Traffic Management* (PANS-ATM), provides for a comprehensive update of the procedures as well as a major reorganization of the contents. The new title reflects that provisions and procedures relating to safety management of air traffic services and to air traffic flow management are included.

2. Scope and purpose

2.1 The *Procedures for Air Navigation Services — Air Traffic Management* (PANS-ATM) are complementary to the Standards and Recommended Practices contained in Annex 2 — *Rules of the Air* and in Annex 11 — *Air Traffic Services*. They are supplemented when necessary by regional procedures contained in the *Regional Supplementary Procedures* (Doc 7030).

Note 1.— Although these procedures are mainly directed to air traffic services personnel, flight crews should be familiar with the procedures contained in the following chapters of the document:

Chapters 3 through 9, 12 through 15, Chapter 16, Sections 16.3, 16.5 and 16.6 and Appendices 1, 2, 4 and 5.

Note 2.— The objectives of the air traffic control service as prescribed in Annex 11 do not include prevention of collision with terrain. The procedures prescribed in this document do not relieve pilots of their responsibility to ensure that any clearances issued by air traffic control units are safe in this respect. When an IFR flight is vectored or is given a direct routing which takes the aircraft off an ATS route, the procedures in Chapter 8, 8.6.5.2 apply.

2.2 The *Procedures for Air Navigation Services — Air Traffic Management* (PANS-ATM) specify, in greater detail than in the Standards and Recommended Practices, the actual procedures to be applied by air traffic services units in providing the various air traffic services to air traffic.

3. Status

3.1 The Procedures for Air Navigation Services (PANS) do not have the same status as the Standards and Recommended Practices. While the latter are *adopted* by Council in pursuance of Article 37 of the Convention on International Civil Aviation, subject to the full procedure of Article 90, the PANS are *approved* by the Council and recommended to Contracting States for worldwide application.

3.2 While the PANS may contain material which may eventually become Standards or Recommended Practices (SARPs) when it has reached the maturity and stability necessary for adoption as such, they may also comprise material prepared as an amplification of the basic principles in the corresponding SARPs, and designed particularly to assist the user in the application of those SARPs.

4. Implementation

The implementation of procedures is the responsibility of Contracting States; they are applied in actual operations only after, and in so far as, States have enforced them. However, with a view to facilitating their processing towards implementation by States, they have been prepared in language which will permit direct use by air traffic services personnel and others associated with the provision of air traffic services to international air navigation.

5. Publication of differences

5.1 The PANS do not carry the status afforded to Standards adopted by the Council as Annexes to the Convention and, therefore, do not come within the obligation imposed by Article 38 of the Convention to notify differences in the event of non-implementation.

5.2 However, attention of States is drawn to the provision of Annex 15 related to the publication in their Aeronautical Information Publications of lists of significant differences between their procedures and the related ICAO procedures.

6. Promulgation of information

Information relating to the establishment and withdrawal of and changes to facilities, services and procedures affecting aircraft operations provided according to the Procedures specified in this document should be notified and take effect in accordance with Annex 15.

7. Contents of the document

Chapter 1 contains definitions.

Chapter 2 contains provisions and procedures regarding safety management of the air traffic services.

Chapter 3 contains provisions and procedures applicable to air traffic flow management.

Chapter 4 contains general provisions and procedures applicable to the air traffic services.

Chapter 5 contains provisions and procedures applicable to the separation of aircraft.

Chapter 6 contains provisions and procedures applicable to departing and arriving aircraft.

Chapter 7 contains provisions and procedures applicable by air traffic control units providing aerodrome control service.

Note.— The procedures for operating aeronautical ground lights have been included in Chapter 7 (Section 7.15) since they concern mostly aerodromes. It should be noted that all aeronautical ground lights are included whether or not they are on or in the vicinity of an aerodrome, and that the whole of Section 7.15 applies to all aerodromes, whether or not aerodrome control service is provided.

Chapter 8 contains procedures applicable by air traffic services units using radar in the performance of their functions.

Chapter 9 contains procedures applicable by air traffic services units providing flight information service and alerting service.

Chapter 10 contains procedures regarding the coordination to be effected between air traffic services units, between control positions within such units, and between such units and associated aeronautical telecommunication stations.

Chapter 11 contains procedures relating to the air traffic services messages which are necessary for the effective operation of air traffic services.

Chapter 12 contains typical phraseologies to be used in the provision of air traffic services, arranged in groups to relate to the particular phase of air traffic services with which they are generally employed.

Chapter 13 contains procedures regarding automatic dependent surveillance — contract (ADS-C) services.

Chapter 14 contains procedures concerning controller-pilot data link communications (CPDLC). The associated CPDLC message set is contained in Appendix 5.

Chapter 15 contains procedures related to emergencies, communication failure and contingencies.

Chapter 16 contains procedures applicable to special air operations, to incident reporting and to repetitive flight plans.

Table A. Amendments to the PANS-ATM

<i>Amendment</i>	<i>Source(s)</i>	<i>Subject(s)</i>	<i>Approved Applicable</i>
1st Edition (1946)	North Atlantic Route Conference (1946)	<i>Procedures for Air Navigation Services — Air Traffic Control</i> (PANS-ATC).	} Implemented on a regional basis on various dates and applicable from 1 February 1950 on a worldwide basis.
2nd Edition (1946)	Conference on European-Mediterranean Route Service Organization (1946)	Revision of the original procedures.	
3rd Edition (1947)	Rules of the Air and Air Traffic Control (RAC) Division, Second Session (1946/1947)	Revision of the second edition.	
4th Edition	Rules of the Air and Air Traffic Control (RAC) Division, Fourth Session (1950)	<i>Procedures for Air Navigation Services — Rules of the Air and Air Traffic Services</i> (PANS-RAC). Inclusion of procedures applicable to pilots and of procedures regarding the provision of flight information and alerting service; change of title to reflect these inclusions.	28 November 1951 1 September 1952
5th Edition	First Air Navigation Conference (1953); AGA Division, Fifth Session (1952)	Position reporting procedures; holding procedures phraseology; radar approach control procedures and phraseology; operation of aeronautical ground lights; air-ground communications failure; air-reports; flight plan AIREP and POMAR forms.	8 December 1953 1 September 1954
6th Edition	Second Air Navigation Conference (1955)	Separation minima; VFR on-top; coordination between adjacent area control centres; objectives and functions of air traffic advisory service; alerting service and search and rescue service; POMAR form.	11 May 1956 1 December 1956
7th Edition	Rules of the Air, Air Traffic Services and Search and Rescue (RAC/SAR) Division (1958)	Introduction of a new flight plan form; major revision of the provisions relating to flight plans and the issuance of clearances based thereon; revision of flight plan messages; standardized content for messages relating to emergency phases; changes to the separation minima requirements; contents of position reports; restrictions in the issuance of clearances to fly maintaining VMC; transfer of responsibility for control from one ATC unit to another; procedures for approach control service; objectives and functions of the air traffic advisory service; phraseologies for ATS; consolidation of all provisions regarding flight plans, the flight plan form and instructions for completion of same.	18 February 1960 1 August 1960
Amendment 1 to the 7th Edition	Panel for Coordinating Procedures respecting the Supply of Information for Aircraft Information, First Meeting (1959); Meteorology Division, Fifth Session (1959)	Transmission of meteorological information to aircraft in flight; revision of the Air-report and AIREP form.	2 December 1960 1 July 1961
Amendment 2 to the 7th Edition	Air Navigation Commission	Altimeter setting procedures.	26 June 1961 1 October 1961
Amendment 3 to the 7th Edition	Air Navigation Commission	Change to flight plan form to cater for flights through intermediate stops.	15 December 1961 1 July 1962

<i>Amendment</i>	<i>Source(s)</i>	<i>Subject(s)</i>	<i>Approved Applicable</i>
Amendment 4 to the 7th Edition	Air Navigation Commission	Additional provisions relating to alerting service.	13 April 1962 1 November 1962
Amendment 5 to the 7th Edition	Air Navigation Commission	Changes and additions to the provisions relating to the operation of aeronautical ground lights.	12 December 1962 1 March 1963
Amendment 6 to the 7th Edition	Air Navigation Commission	Definition for “D-value”.	8 April 1963 1 November 1963
Amendment 7 to the 7th Edition	Meteorological and Operations (MET/OPS) Divisional Meeting (1964)	Aircraft meteorological observations and reports.	31 May 1965 10 March 1966
8th Edition	Rules of the Air and Air Traffic Services/Operations (RAC/OPS) Divisional Meeting (1963); Air Traffic Control Automation Panel (ATCAP), Fourth Meeting (1964)	New separation criteria and minima; control of VFR flights; essential traffic information; air traffic services coordination; phraseology including radar phraseology.	29 November 1965 25 August 1966
Amendment 1 to the 8th Edition	Air Navigation Commission	Introduction of a new part on the use of radar in air traffic services and consequential changes to other parts. Expression of vertical position.	20 February 1967 24 August 1967
9th Edition	Air Traffic Control Automation Panel (ATCAP), Fifth Meeting (1966)	Changes to the provisions concerning air traffic services data to facilitate the application of automation in air traffic control; guidance material on ATC automation and flow control.	7 June 1967 8 February 1968
Amendment 1 to the 9th Edition	Fifth Air Navigation Conference (1967)	Changes to all parts to improve the safety and efficiency of international air operations in the approach, landing and take-off phases.	23 January 1969 18 September 1969
10th Edition	Sixth Air Navigation Conference (1969)	Position reporting and reporting of operational and meteorological information; types of flights to be provided with separation; VMC clearances; Mach number technique; use of SSR in the air traffic services; application of separation minima; clearances; addressing of ATS messages; flight information service and alerting service; guidance material on the application of the Mach number technique on the use of secondary surveillance radar in the air traffic services and on a standard form and attendant procedures for the reporting of air traffic incidents.	1 June 1970 4 February 1971
Amendment 1 to the 10th Edition	Sixth Air Navigation Conference (1969); LIM EUM (RAC/COM) RAN Meeting (1969)	Changes to the format and data conventions for air-report messages. Estimated time of departure/arrival in ATS messages.	24 March 1972 7 December 1972
Amendment 2 to the 10th Edition	Air Navigation Commission	Authority over aircraft operating over the high seas.	15 November 1972 16 August 1973
Amendment 3 to the 10th Edition	Air Navigation Commission	Guidance material on repetitive flight plans.	13 December 1972 16 August 1973
Amendment 4 to the 10th Edition	Seventh Air Navigation Conference (1972)	Area navigation practices; position reports; SSR radiotelephony phraseology; guidance material on the use of SSR.	23 March 1973 23 May 1974

<i>Amendment</i>	<i>Source(s)</i>	<i>Subject(s)</i>	<i>Approved Applicable</i>
Amendment 5 to the 10th Edition	Council action in pursuance of Assembly Resolutions A17-10 and A18-10	ATS practices in the event an aircraft is being subjected to unlawful interference.	7 December 1973 23 May 1974
Amendment 6 to the 10th Edition	Various sources including Sixth EUM/RAN Meeting, a proposal by the United Kingdom, various actions of the Council and the Air Navigation Commission	Altimeter setting; radar identification and transfer; automatic terminal information service (ATIS); communication failure procedures.	8 April 1974 27 February 1975
Amendment 7 to the 10th Edition	Technical Panel on Supersonic Transport Operations; Air Navigation Commission; Council	Supersonic aircraft operations; interception of aircraft; definition of "emergency phase".	4 February 1975 9 October 1975
Amendment 8 to the 10th Edition	Air Navigation Commission; Amendments to Annexes 3 and 10	SSR Code 7500; information to aircraft and air-reporting by aircraft; frequencies for survival radio equipment.	12 December 1975 30 December 1976
Amendment 9 to the 10th Edition	Technical Panel on Supersonic Transport Operations; Air Navigation Commission; Amendment to Annex 14	Supersonic aircraft operations; unlawful interference.	7 April 1976 30 December 1976
11th Edition	Ninth Air Navigation Conference (1976); Air Navigation Commission; Amendments to Annexes 3 and 14	Definitions; ATS flight plans and messages; guidance material regarding repetitive flight plans; separation between aircraft; guidance material regarding wake turbulence and related separation minima; use of information derived from secondary surveillance radar; guidance material concerning radar separation based on computer-processed radar data; operation of aeronautical ground lights.	9 December 1977 10 August 1978
Amendment 1 to the 11th Edition	Air Navigation Commission	Designation of standard departure and arrival routes.	3 December 1979 27 November 1980
Amendment 2 to the 11th Edition	Air Navigation Commission	Definitions; coordination of activities which constitute a potential hazard to flights of civil aircraft; unmanned free balloons.	4 March 1981 26 November 1981
Amendment 3 to the 11th Edition	Air Navigation Commission	Action to be taken by an ATS unit when it becomes aware that an aircraft has deviated from its intended track or reports that it is lost.	1 April 1981 26 November 1981
Amendment 4 to the 11th Edition	Amendment 29 to Annex 11	Automatic terminal information service (ATIS); transferred to Annex 11.	2 April 1982 25 November 1982
Amendment 5 to the 11th Edition	AGA Divisional Meeting (1981); ATS Data Acquisition, Processing and Transfer Panel, Third Meeting (1981); Air Navigation Commission	Definitions; wind shear; surface movement guidance and control; message priority; radiotelephony phraseologies; communications requirements; units of measurement.	13 May 1983 7 June 1984
12th Edition	ATS Data Acquisition, Processing and Transfer Panel, Third Meeting (1981); Air Navigation Commission	Definitions; contents of flight plans; repetitive flight plans; ATS data interchange; Coordinated Universal Time (UTC).	26 June 1984 21 November 1985
Amendment 1 to the 12th Edition	Council; Air Navigation Commission	Strayed or unidentified aircraft; interception of civil aircraft; provision of flight plan and flight progress information; use of radar.	14 March 1986 20 November 1986

<i>Amendment</i>	<i>Source(s)</i>	<i>Subject(s)</i>	<i>Approved Applicable</i>
Amendment 2 to the 12th Edition	Air Navigation Commission	Definitions; position and air-reporting; change of aircraft call signs during flight; airborne SSR Mode S capability; reporting of volcanic activity; introduction of three-letter designators; transmission of numbers on radiotelephony; inclusion of English language phraseology in the French, Russian and Spanish editions; deletion of all attachments.	27 March 1987 22 October 1987
Amendment 3 to the 12th Edition	Secretariat; Visual Flight Rules Operations Panel (VFOP), Third Meeting (1986); Air Navigation Commission; amendments consequential to adoption of amendments to Annex 6	Operation of aircraft in mixed VFR/IFR environments; surface movement guidance and control; simultaneous operations on parallel or near-parallel instrument runways; acts of unlawful interference; wake turbulence categories and separation minima.	19 March 1990 14 November 1991
Amendment 4 to the 12th Edition	Secondary Surveillance Radar Improvements and Collision Avoidance Systems Panel, Fourth Meeting (SICASP/4) (1989)	Definitions; provision of air traffic services irrespective of airborne collision avoidance system (ACAS) operation.	26 February 1993 11 November 1993
Amendment 5 to the 12th Edition	Review of the General Concept of Separation Panel (RGCSP), Seventh Meeting (1990), Eighth Meeting (1993); Automatic Dependent Surveillance Panel (ADSP), Second Meeting (1992); All Weather Operations Panel (AWOP), Twelfth Meeting (1987); SSR Improvements and Collision Avoidance Systems Panel (SICASP), Fourth Meeting (1989); Obstacle Clearance Panel (OCP), Ninth Meeting (1990); Limited North Atlantic (COM/MET/RAC) Regional Air Navigation Meeting (1992); COM/MET/OPS Divisional Meeting (1990); Air Navigation Commission	Definitions; reduced vertical separation minimum of 300 m (1 000 ft) above FL 290; area navigation (RNAV) criteria; required navigation performance; automatic dependent surveillance; identification of medical aircraft; integration of helicopter traffic with conventional aeroplane traffic; inclusion of en-route alternates on the flight plan; surface movement radar; air traffic incident reporting; air-reporting procedures; transmission of information to aircraft on radioactive material and toxic chemical “clouds”; meteorological information in ATS messages; identification of runway visual range (RVR) reporting position; ATS aspects of MLS operations; use of SSR alone for separation purposes; ground proximity warning systems (GPWS).	18 March 1994 10 November 1994
Amendment 6 to the 12th Edition	Air Navigation Commission	Simultaneous operations on parallel or near-parallel instrument runways.	13 March 1995 9 November 1995
13th Edition	Secretariat; SSR Improvements and Collision Avoidance Systems Panel (SICASP), Fifth Meeting (1993); All Weather Operations Panel	Use of radar in air traffic services; airborne collision avoidance systems (ACAS); approach instructions for microwave landing system (MLS)/area navigation (RNAV) procedures.	21 March 1996 7 November 1996
Amendment 1 to the 13th Edition	Air Navigation Commission	Definitions; AIREP formats and automated air-reporting; forwarding of meteorological information; separation between aircraft; adequacy of distress and urgency communication procedures; and communication failure procedures.	5 March 1997 6 November 1997
Amendment 2 to the 13th Edition	Automatic Dependent Surveillance Panel, Fourth Meeting (1996); Review of the General Concept of Separation Panel, Ninth Meeting (1996)	Automatic dependent surveillance; data interchange between automatic ATS systems; ATS applications for air-ground data links; separation between aircraft; required navigation performance; and required navigation performance and area navigation for en-route operations.	19 March 1998 5 November 1998

<i>Amendment</i>	<i>Source(s)</i>	<i>Subject(s)</i>	<i>Approved Applicable</i>
Amendment 3 to the 13th Edition	Air Navigation Commission; Visual Aids Panel, Thirteenth Meeting (1997)	ATS airspace classifications; visual meteorological conditions clearance; and runway-holding position.	10 March 1999 4 November 1999
14th Edition	Air Navigation; Secretariat; fifth meeting of the Automatic Dependent Surveillance Panel (ADSP/5); Multi-Agency Air Traffic Services Procedures Coordination Group (MAPCOG); thirty-ninth meeting of the European Air Navigation Planning Group (EANPG/39); eleventh and twelfth meetings of the Obstacle Clearance Panel (OCP/11 and OCP/12); Amendment 72 to Annex 3 — <i>Meteorological Service for International Air Navigation</i> ; Amendments 25, 20 and 7 to Annex 6 — <i>Operation of Aircraft</i> , Parts I, II and III; Amendments 26, 21 and 8 to Annex 6, Parts I, II and III	Renaming of document to <i>Procedures for Air Navigation Services — Air Traffic Management</i> (PANS-ATM); Chapter 1 — Definitions. New and revised definitions; New Chapter 2 — ATS Safety Management. Introduction of new provisions relating to ATS safety management; New Chapter 3 — ATS System Capacity and Air Traffic Flow Management. Introduction of new provisions relating to ATFM procedures and capacity management; Chapter 4 — General Provisions for Air Traffic Services. Restructuring of the material, changes to readback requirements, and expansion of the provisions relating to speed control; Chapter 5 — Separation Methods and Minima. Restructuring, and editorial changes to improve clarity; Chapter 6 — Separation in the Vicinity of Aerodromes. Restructuring, introduction of new provisions relating to standard clearances for arriving and departing aircraft; Chapter 7 — Procedures for Aerodrome Control Service. Restructuring, introduction of new provisions relating to low visibility operations; Chapter 8 — Radar Services. Restructuring and editorial changes; Chapter 9 — Flight Information Service and Alerting Service. Renumbering of paragraphs only; Chapter 10 — Coordination. Introduction of new general provisions relating to ATS coordination, renumbering of existing paragraphs and editorial changes; Chapter 11 — Air Traffic Services Messages. Renumbering of paragraphs only; editorial amendments. Chapter 12 — Phraseologies. Amended procedures aimed at harmonizing radiotelephony speech and improving the use of standard phraseology; Chapter 14 — Controller-Pilot Data Link Communications (CPDLC). Amended and new procedures to facilitate implementation of the available technology in relation to CPDLC and data link — flight information services (D-FIS); New Chapter 15 — Procedures related to Emergencies, Communication Failure and Contingencies. Contains relocated and new provisions dealing with emergency situations; Chapter 16 — Miscellaneous Procedures. Relocated provisions dealing with military traffic, unmanned free balloons, air traffic incident reports and use of repetitive flight plans; and miscellaneous editorial amendments.	29 June 2001 1 November 2001
Amendment 1 to the 14th Edition	Fifth meeting of the Automatic Dependent Surveillance Panel (ADSP/5); tenth meeting of the Review of the General Concept of Separation Panel (RGCS/10)	Automatic dependent surveillance; lateral separation on intersecting tracks for RNAV operations where RNP is specified; 55.5 km (30 NM) longitudinal separation and the requirement for ADS to implement this separation minimum.	28 May 2002 28 November 2002

<i>Amendment</i>	<i>Source(s)</i>	<i>Subject(s)</i>	<i>Approved Applicable</i>
2	Separation and Airspace Safety Panel; and Secretariat and the Proficiency Requirements in Common English Study Group	Tolerance values to be used by controllers for verification of the accuracy of the level information reported by Mode C; language proficiency requirements; and editorial amendment to Appendix 1.	26 March 2003 27 November 2003
3	Secretariat/Air Navigation Commission; Meteorology Divisional Meeting (2002); Recommendation 3/3 of the fourth meeting of the Global Navigation Satellite System Panel (GNSSP/4).	Runway incursions; phraseologies concerning 8.33 kHz channel spacing, RVSM and GNSS; special air-reports and other meteorological information; and amendment of definitions.	29 June 2004 25 November 2004
4	Secretariat	Definitions; meteorological information; special procedures for in-flight contingencies in oceanic airspace; reduced runway separation minima; air-ground communications failure procedures; phraseologies for use on and in the vicinity of the aerodrome.	31 March 2005 24 November 2005
15th Edition	Secretariat/Air Navigation Commission; Separation and Airspace Safety Panel (SASP); Operational Data Link Panel (OPLINKP); Surveillance and Conflict Resolution Systems Panel (SCRSP); Operations Panel (OPSP); International Airways Volcano Watch Operations Group (IAVWOPSG)	Definitions; procedures for ADS-B, ADS-C, AIDC, CPDLC and RCP; pilot procedures in the event of unlawful interference; coordination procedures between ATS and other entities; name-code designators; criteria for the selection of preferential runways; procedures and phraseologies relating to ACAS; procedures related to volcanic ash.	1 June 2007 22 November 2007
1	Flight Plan Study Group (FPLSG)	Update the ICAO model flight plan form.	27 May 2008 15 November 2012
2	Secretariat/Instrument Flight Procedures Panel first working group of the whole meeting (IFPP-WG/WHL/1)	Definitions; horizontal speed control instructions; procedures for arriving aircraft; runway incursion and reporting; phraseologies for use on the aerodrome; special procedures for in-flight contingencies in Oceanic airspace; short-term conflict alert procedures (STCA); strategic lateral offset procedures (SLOP); notification of suspected communicable diseases on board an aircraft.	26 June 2009 19 November 2009
3	Secretariat; Separation and Airspace Safety Panel (SASP); Meteorological Information Data Link Study Group (METLINKSG); International Airways Volcano Watch Operations Group (IAVWOPSG)	Amendment to definitions; aircraft separation minima; lateral separation of aircraft in terminal areas; and air-reporting.	12 October 2010 18 November 2010
4	Secretariat; Separation and Airspace Safety Panel (SASP); Operations Panel (OPSP) Twelfth Working Group of the Whole Meeting (WG/WHL/12); and Air Navigation Commission	Amendment to the foreword; definitions; separation minimum using ADS-B and/or multilateration systems; and provisions for phraseology and air traffic control (ATC) procedures related to fuel aligned with Annex 6 requirements.	16 March 2012 15 November 2012

<i>Amendment</i>	<i>Source(s)</i>	<i>Subject(s)</i>	<i>Approved Applicable</i>
5	Secretariat supported by the Approach Classification Task Force (ACTF) in coordination with the Aerodromes Panel (AP), the Instrument Flight Procedures Panel (IFPP), the Navigation Systems Panel (NSP) and the Operations Panel (OPSP)	Amendment concerning definitions related to instrument approach operations and procedures as a result of the new approach classification.	20 March 2013 13 November 2014
6	Secretariat; Separation and Airspace Safety Panel (SASP); International Volcanic Ash Task Force (IVATF); Operational Data Link Panel (OPLINKP); and Aerodrome Panel (AP)	Amendment to definitions; controller pilot data link communication (CPDLC) procedures; in-trail procedure (ITP); automatic dependent surveillance – contract (ADS-C) procedures; volcanic ash cloud, strategic lateral offset procedures (SLOP); 9.3 km (5 NM) terminal separation based on RNP, PBN lateral separation and VOR/GNSS lateral separation and consequential ATC phraseologies.	20 June 2014 13 November 2014
7-A (16th edition)	The Separation and Airspace Safety Panel (SASP), the second meeting of the Operational Data Link Panel (OPLINKP/2), the third meeting of the Air Traffic Management Operations Panel (ATMOPSP/3) and the Secretariat, the first meeting of the Flight Operations Panel (FTOPSP/1), the sixteenth meeting of the Operations Panel Working Group of the Whole (OPSP/WG/WHL/16), the third meeting of the Aerodromes Panel (AP/3) and the Meteorology (MET) Divisional Meeting (2014).	Performance-based longitudinal and lateral separation minima and ADS-C CDP; separation between arrival and departure operations; DLIC, CPDLC, ADS-C, PBCS and SATVOICE; procedures used to vector for final approach, advising of TORA and SID/STAR; standard phraseology for ground and flight de/anti-icing crews; emergency descent procedures; autonomous runway incursion warning system (ARIWS); and forwarding of special air-reports and definition of SIGMET information.	6 June 2016 10 November 2016

Chapter 1

DEFINITIONS

Note 1.— Throughout the text of this document the term “service” is used as an abstract noun to designate functions, or service rendered; the term “unit” is used to designate a collective body performing a service.

Note 2.— All references to “Radio Regulations” are to the Radio Regulations published by the International Telecommunication Union (ITU). Radio Regulations are amended from time to time by the decisions embodied in the Final Acts of World Radiocommunication Conferences held normally every two to three years. Further information on the ITU processes as they relate to aeronautical radio system frequency use is contained in the Handbook on Radio Frequency Spectrum Requirements for Civil Aviation including statement of approved ICAO policies (Doc 9718).

When the following terms are used in the present document they have the following meanings:

Accepting unit/controller. Air traffic control unit/air traffic controller next to take control of an aircraft.

Note.— See definition of “transferring unit/controller”.

ADS-C agreement. A reporting plan which establishes the conditions of ADS-C data reporting (i.e. data required by the air traffic services unit and frequency of ADS-C reports which have to be agreed to prior to using ADS-C in the provision of air traffic services).

Note.— The terms of the agreement will be exchanged between the ground system and the aircraft by means of a contract, or a series of contracts.

Advisory airspace. An airspace of defined dimensions, or designated route, within which air traffic advisory service is available.

Advisory route. A designated route along which air traffic advisory service is available.

Note.— Air traffic control service provides a much more complete service than air traffic advisory service; advisory areas and routes are therefore not established within controlled airspace, but air traffic advisory service may be provided below and above control areas.

Aerodrome. A defined area on land or water (including any buildings, installations and equipment) intended to be used either wholly or in part for the arrival, departure and surface movement of aircraft.

Note.— The term “aerodrome” where used in the provisions relating to flight plans and ATS messages is intended to cover also sites other than aerodromes which may be used by certain types of aircraft, e.g. helicopters or balloons.

Aerodrome control service. Air traffic control service for aerodrome traffic.

Aerodrome control tower. A unit established to provide air traffic control service to aerodrome traffic.

Aerodrome elevation. The elevation of the highest point of the landing area.

Aerodrome traffic. All traffic on the manoeuvring area of an aerodrome and all aircraft flying in the vicinity of an aerodrome.

Note.— *An aircraft is in the vicinity of an aerodrome when it is in, entering or leaving an aerodrome traffic circuit.*

Aerodrome traffic circuit. The specified path to be flown by aircraft operating in the vicinity of an aerodrome.

Aeronautical fixed service (AFS). A telecommunication service between specified fixed points provided primarily for the safety of air navigation and for the regular, efficient and economical operation of air services.

Aeronautical fixed station. A station in the aeronautical fixed service.

Aeronautical ground light. Any light specially provided as an aid to air navigation, other than a light displayed on an aircraft.

Aeronautical Information Publication (AIP). A publication issued by or with the authority of a State and containing aeronautical information of a lasting character essential to air navigation.

Aeronautical mobile service (RR SI.32). A mobile service between aeronautical stations and aircraft stations, or between aircraft stations, in which survival craft stations may participate; emergency position-indicating radio beacon stations may also participate in this service on designated distress and emergency frequencies.

Aeronautical station (RR SI.81). A land station in the aeronautical mobile service. In certain instances, an aeronautical station may be located, for example, on board ship or on a platform at sea.

Aeronautical telecommunication station. A station in the aeronautical telecommunication service.

Airborne collision avoidance system (ACAS). An aircraft system based on secondary surveillance radar (SSR) transponder signals which operates independently of ground-based equipment to provide advice to the pilot on potential conflicting aircraft that are equipped with SSR transponders.

Aircraft. Any machine that can derive support in the atmosphere from the reactions of the air other than the reactions of the air against the earth's surface.

Aircraft address. A unique combination of 24 bits available for assignment to an aircraft for the purpose of air-ground communications, navigation and surveillance.

Aircraft identification. A group of letters, figures or a combination thereof which is either identical to, or the coded equivalent of, the aircraft call sign to be used in air-ground communications, and which is used to identify the aircraft in ground-ground air traffic services communications.

Aircraft observation. The evaluation of one or more meteorological elements made from an aircraft in flight.

Aircraft proximity. A situation in which, in the opinion of a pilot or air traffic services personnel, the distance between aircraft as well as their relative positions and speed have been such that the safety of the aircraft involved may have been compromised. An aircraft proximity is classified as follows:

Risk of collision. The risk classification of an aircraft proximity in which serious risk of collision has existed.

Safety not assured. The risk classification of an aircraft proximity in which the safety of the aircraft may have been compromised.

No risk of collision. The risk classification of an aircraft proximity in which no risk of collision has existed.

Risk not determined. The risk classification of an aircraft proximity in which insufficient information was available to determine the risk involved, or inconclusive or conflicting evidence precluded such determination.

Air-ground communication. Two-way communication between aircraft and stations or locations on the surface of the earth.

AIRMET information. Information issued by a meteorological watch office concerning the occurrence or expected occurrence of specified en-route weather phenomena which may affect the safety of low-level aircraft operations and which was not already included in the forecast issued for low-level flights in the flight information region concerned or sub-area thereof.

AIRPROX. The code word used in an air traffic incident report to designate aircraft proximity.

Air-report. A report from an aircraft in flight prepared in conformity with requirements for position, and operational and/or meteorological reporting.

Air-taxiing. Movement of a helicopter/VTOL above the surface of an aerodrome, normally in ground effect and at a ground speed normally less than 37 km/h (20 kt).

Note.— The actual height may vary, and some helicopters may require air-taxiing above 8 m (25 ft) AGL to reduce ground effect turbulence or provide clearance for cargo slingloads.

Air-to-ground communication. One-way communication from aircraft to stations or locations on the surface of the earth.

Air traffic. All aircraft in flight or operating on the manoeuvring area of an aerodrome.

Air traffic advisory service. A service provided within advisory airspace to ensure separation, in so far as practical, between aircraft which are operating on IFR flight plans.

Air traffic control clearance. Authorization for an aircraft to proceed under conditions specified by an air traffic control unit.

Note 1.— For convenience, the term “air traffic control clearance” is frequently abbreviated to “clearance” when used in appropriate contexts.

Note 2.— The abbreviated term “clearance” may be prefixed by the words “taxi”, “take-off”, “departure”, “en-route”, “approach” or “landing” to indicate the particular portion of flight to which the air traffic control clearance relates.

Air traffic control instruction. Directives issued by air traffic control for the purpose of requiring a pilot to take a specific action.

Air traffic control service. A service provided for the purpose of:

- a) preventing collisions:
 - 1) between aircraft, and
 - 2) on the manoeuvring area between aircraft and obstructions; and
- b) expediting and maintaining an orderly flow of air traffic.

Air traffic control unit. A generic term meaning variously, area control centre, approach control unit or aerodrome control tower.

Air traffic flow management (ATFM). A service established with the objective of contributing to a safe, orderly and expeditious flow of air traffic by ensuring that ATC capacity is utilized to the maximum extent possible, and that the traffic volume is compatible with the capacities declared by the appropriate ATS authority.

Air traffic management (ATM). The dynamic, integrated management of air traffic and airspace including air traffic services, airspace management and air traffic flow management — safely, economically and efficiently — through the provision of facilities and seamless services in collaboration with all parties and involving airborne and ground-based functions.

Air traffic management system. A system that provides ATM through the collaborative integration of humans, information, technology, facilities and services, supported by air and ground- and/or space-based communications, navigation and surveillance.

Air traffic service (ATS). A generic term meaning variously, flight information service, alerting service, air traffic advisory service, air traffic control service (area control service, approach control service or aerodrome control service).

Air traffic services airspaces. Airspaces of defined dimensions, alphabetically designated, within which specific types of flights may operate and for which air traffic services and rules of operation are specified.

Note.— *ATS airspaces are classified as Class A to G as shown in Annex 11, Appendix 4.*

Air traffic services reporting office. A unit established for the purpose of receiving reports concerning air traffic services and flight plans submitted before departure.

Note.— *An air traffic services reporting office may be established as a separate unit or combined with an existing unit, such as another air traffic services unit, or a unit of the aeronautical information service.*

Air traffic services unit. A generic term meaning variously, air traffic control unit, flight information centre or air traffic services reporting office.

Airway. A control area or portion thereof established in the form of a corridor.

ALERFA. The code word used to designate an alert phase.

Alerting service. A service provided to notify appropriate organizations regarding aircraft in need of search and rescue aid, and assist such organizations as required.

Alert phase. A situation wherein apprehension exists as to the safety of an aircraft and its occupants.

Allocation, allocate. Distribution of frequencies, SSR codes, etc. to a State, unit or service. Distribution of 24-bit aircraft addresses to a State or common mark registering authority.

Alphanumeric characters (alphanumerics). A collective term for letters and figures (digits).

Alternate aerodrome. An aerodrome to which an aircraft may proceed when it becomes either impossible or inadvisable to proceed to or to land at the aerodrome of intended landing where the necessary services and facilities are available, where aircraft performance requirements can be met and which is operational at the expected time of use. Alternate aerodromes include the following:

Take-off alternate. An alternate aerodrome at which an aircraft would be able to land should this become necessary shortly after take-off and it is not possible to use the aerodrome of departure.

En-route alternate. An alternate aerodrome at which an aircraft would be able to land in the event that a diversion becomes necessary while en route.

Destination alternate. An alternate aerodrome at which an aircraft would be able to land should it become either impossible or inadvisable to land at the aerodrome of intended landing.

Note.— *The aerodrome from which a flight departs may also be an en-route or a destination alternate aerodrome for that flight.*

Altitude. The vertical distance of a level, a point or an object considered as a point, measured from mean sea level (MSL).

Approach control service. Air traffic control service for arriving or departing controlled flights.

Approach control unit. A unit established to provide air traffic control service to controlled flights arriving at, or departing from, one or more aerodromes.

Approach sequence. The order in which two or more aircraft are cleared to approach to land at the aerodrome.

Appropriate ATS authority. The relevant authority designated by the State responsible for providing air traffic services in the airspace concerned.

Appropriate authority.

- a) Regarding flight over the high seas: The relevant authority of the State of Registry.
- b) Regarding flight other than over the high seas: The relevant authority of the State having sovereignty over the territory being overflown.

Apron. A defined area, on a land aerodrome, intended to accommodate aircraft for purposes of loading or unloading passengers, mail or cargo, fuelling, parking or maintenance.

Area control centre (ACC). A unit established to provide air traffic control service to controlled flights in control areas under its jurisdiction.

Area control service. Air traffic control service for controlled flights in control areas.

Area navigation (RNAV). A method of navigation which permits aircraft operation on any desired flight path within the coverage of ground- or space-based navigation aids or within the limits of the capability of self-contained aids, or a combination of these.

Area navigation route. An ATS route established for the use of aircraft capable of employing area navigation.

Assignment, assign. Distribution of frequencies to stations. Distribution of SSR codes or 24-bit aircraft addresses to aircraft.

ATIS. The symbol used to designate automatic terminal information service.

ATS route. A specified route designed for channelling the flow of traffic as necessary for the provision of air traffic services.

Note 1.— *The term “ATS route” is used to mean variously, airway, advisory route, controlled or uncontrolled route, arrival or departure route, etc.*

Note 2.— *An ATS route is defined by route specifications which include an ATS route designator, the track to or from significant points (waypoints), distance between significant points, reporting requirements and, as determined by the appropriate ATS authority, the lowest safe altitude.*

ATS surveillance service. A term used to indicate a service provided directly by means of an ATS surveillance system.

ATS surveillance system. A generic term meaning variously, ADS-B, PSR, SSR or any comparable ground-based system that enables the identification of aircraft.

Note.— A comparable ground-based system is one that has been demonstrated, by comparative assessment or other methodology, to have a level of safety and performance equal to or better than monopulse SSR.

Automatic dependent surveillance — broadcast (ADS-B). A means by which aircraft, aerodrome vehicles and other objects can automatically transmit and/or receive data such as identification, position and additional data, as appropriate, in a broadcast mode via a data link.

Automatic dependent surveillance — contract (ADS-C). A means by which the terms of an ADS-C agreement will be exchanged between the ground system and the aircraft, via a data link, specifying under what conditions ADS-C reports would be initiated, and what data would be contained in the reports.

Note.— The abbreviated term “ADS contract” is commonly used to refer to ADS event contract, ADS demand contract, ADS periodic contract or an emergency mode.

Automatic terminal information service (ATIS). The automatic provision of current, routine information to arriving and departing aircraft throughout 24 hours or a specified portion thereof:

Data link-automatic terminal information service (D-ATIS). The provision of ATIS via data link.

Voice-automatic terminal information service (Voice-ATIS). The provision of ATIS by means of continuous and repetitive voice broadcasts.

Base turn. A turn executed by the aircraft during the initial approach between the end of the outbound track and the beginning of the intermediate or final approach track. The tracks are not reciprocal.

Note.— Base turns may be designated as being made either in level flight or while descending, according to the circumstances of each individual procedure.

Blind transmission. A transmission from one station to another station in circumstances where two-way communication cannot be established but where it is believed that the called station is able to receive the transmission.

Broadcast. A transmission of information relating to air navigation that is not addressed to a specific station or stations.

Ceiling. The height above the ground or water of the base of the lowest layer of cloud below 6 000 m (20 000 ft) covering more than half the sky.

Clearance limit. The point to which an aircraft is granted an air traffic control clearance.

Code (SS R). The number assigned to a particular multiple pulse reply signal transmitted by a transponder in Mode A or Mode C.

Common point. A point on the surface of the earth common to the tracks of two aircraft, used as a basis for the application of separation (e.g. significant point, waypoint, navigation aid, fix).

Computer. A device which performs sequences of arithmetical and logical steps upon data without human intervention.

Note.— When the word “computer” is used in this document it may denote a computer complex, which includes one or more computers and peripheral equipment.

Control area. A controlled airspace extending upwards from a specified limit above the earth.

Controlled aerodrome. An aerodrome at which air traffic control service is provided to aerodrome traffic.

Note.— The term “controlled aerodrome” indicates that air traffic control service is provided to aerodrome traffic but does not necessarily imply that a control zone exists.

Controlled airspace. An airspace of defined dimensions within which air traffic control service is provided in accordance with the airspace classification.

Note.— Controlled airspace is a generic term which covers ATS airspace Classes A, B, C, D and E as described in Annex 11, 2.6.

Controlled flight. Any flight which is subject to an air traffic control clearance.

Controller-pilot data link communications (CPDLC). A means of communication between controller and pilot, using data link for ATC communications.

Control zone. A controlled airspace extending upwards from the surface of the earth to a specified upper limit.

CPDLC message. Information exchanged between an airborne system and its ground counterpart. A CPDLC message consists of a single message element or a combination of message elements conveyed in a single transmission by the initiator.

CPDLC message set. A list of standard message elements and free text message elements.

Cruise climb. An aeroplane cruising technique resulting in a net increase in altitude as the aeroplane mass decreases.

Cruising level. A level maintained during a significant portion of a flight.

Current data authority. The designated ground system through which a CPDLC dialogue between a pilot and a controller currently responsible for the flight is permitted to take place.

Current flight plan (CPL). The flight plan, including changes, if any, brought about by subsequent clearances.

Note.— When the word “message” is used as a suffix to this term, it denotes the content and format of the current flight plan data sent from one unit to another.

Data convention. An agreed set of rules governing the manner or sequence in which a set of data may be combined into a meaningful communication.

Data link initiation capability (DLIC). A data link application that provides the ability to exchange addresses, names and version numbers necessary to initiate data link applications.

Data processing. A systematic sequence of operations performed on data.

Note.— Examples of operations are the merging, sorting, computing or any other transformation or rearrangement with the object of extracting or revising information, or of altering the representation of information.

Decision altitude (DA) or decision height (DH). A specified altitude or height in a 3D instrument approach operation at which a missed approach must be initiated if the required visual reference to continue the approach has not been established.

Note 1.— Decision altitude (DA) is referenced to mean sea level and decision height (DH) is referenced to the threshold elevation.

Note 2.— The required visual reference means that section of the visual aids or of the approach area which should have been in view for sufficient time for the pilot to have made an assessment of the aircraft position and rate of change of position, in relation to the desired flight path. In Category III operations with a decision height the required visual reference is that specified for the particular procedure and operation.

Note 3.— For convenience where both expressions are used they may be written in the form “decision altitude/ height” and abbreviated “DA/H”.

Dependent parallel approaches. Simultaneous approaches to parallel or near-parallel instrument runways where radar separation minima between aircraft on adjacent extended runway centre lines are prescribed.

DETRESFA. The code word used to designate a distress phase.

Discrete code. A four-digit SSR code with the last two digits not being “00”.

Distress phase. A situation wherein there is reasonable certainty that an aircraft and its occupants are threatened by grave and imminent danger or require immediate assistance.

Elevation. The vertical distance of a point or a level, on or affixed to the surface of the earth, measured from mean sea level.

Emergency phase. A generic term meaning, as the case may be, uncertainty phase, alert phase or distress phase.

Estimated elapsed time. The estimated time required to proceed from one significant point to another.

Estimated off-block time. The estimated time at which the aircraft will commence movement associated with departure.

Estimated time of arrival. For IFR flights, the time at which it is estimated that the aircraft will arrive over that designated point, defined by reference to navigation aids, from which it is intended that an instrument approach procedure will be commenced, or, if no navigation aid is associated with the aerodrome, the time at which the aircraft will arrive over the aerodrome. For VFR flights, the time at which it is estimated that the aircraft will arrive over the aerodrome.

Expected approach time. The time at which ATC expects that an arriving aircraft, following a delay, will leave the holding fix to complete its approach for a landing.

Note.— The actual time of leaving the holding fix will depend upon the approach clearance.

Filed flight plan (FPL). The flight plan as filed with an ATS unit by the pilot or a designated representative, without any subsequent changes.

Note.— When the word “message” is used as a suffix to this term, it denotes the content and format of the filed flight plan data as transmitted.

Final approach. That part of an instrument approach procedure which commences at the specified final approach fix or point, or where such a fix or point is not specified,

- a) at the end of the last procedure turn, base turn or inbound turn of a racetrack procedure, if specified; or
- b) at the point of interception of the last track specified in the approach procedure; and

ends at a point in the vicinity of an aerodrome from which:

- 1) a landing can be made; or
- 2) a missed approach procedure is initiated.

Flight crew member. A licensed crew member charged with duties essential to the operation of an aircraft during a flight duty period.

Flight information centre. A unit established to provide flight information service and alerting service.

Flight information region (FIR). An airspace of defined dimensions within which flight information service and alerting service are provided.

Flight information service. A service provided for the purpose of giving advice and information useful for the safe and efficient conduct of flights.

Flight level. A surface of constant atmospheric pressure which is related to a specific pressure datum, 1 013.2 hectopascals (hPa), and is separated from other such surfaces by specific pressure intervals.

Note 1.— A pressure type altimeter calibrated in accordance with the Standard Atmosphere:

- a) when set to a QNH altimeter setting, will indicate altitude;
- b) when set to QFE altimeter setting, will indicate height above the QFE reference datum;
- c) when set to a pressure of 1 013.2 hPa, may be used to indicate flight levels.

Note 2.— The terms “height” and “altitude”, used in Note 1 above, indicate altimetric rather than geometric heights and altitudes.

Flight path monitoring. The use of ATS surveillance systems for the purpose of providing aircraft with information and advice relative to significant deviations from nominal flight path, including deviations from the terms of their air traffic control clearances.

Note.— Some applications may require a specific technology, e.g. radar, to support the function of flight path monitoring.

Flight plan. Specified information provided to air traffic services units, relative to an intended flight or portion of a flight of an aircraft.

Note.— Specifications for flight plans are contained in Annex 2. A Model Flight Plan Form is contained in Appendix 2 to this document.

Flight visibility. The visibility forward from the cockpit of an aircraft in flight.

Flow control. Measures designed to adjust the flow of traffic into a given airspace, along a given route, or bound for a given aerodrome, so as to ensure the most effective utilization of the airspace.

Forecast. A statement of expected meteorological conditions for a specified time or period, and for a specified area or portion of airspace.

Free text message element. Part of a message that does not conform to any standard message element in the PANS-ATM (Doc 4444).

Glide path. A descent profile determined for vertical guidance during a final approach.

Ground effect. A condition of improved performance (lift) due to the interference of the surface with the airflow pattern of the rotor system when a helicopter or other VTOL aircraft is operating near the ground.

Note.— Rotor efficiency is increased by ground effect to a height of about one rotor diameter for most helicopters.

Ground visibility. The visibility at an aerodrome, as reported by an accredited observer or by automatic systems.

Heading. The direction in which the longitudinal axis of an aircraft is pointed, usually expressed in degrees from North (true, magnetic, compass or grid).

Height. The vertical distance of a level, a point or an object considered as a point, measured from a specified datum.

Holding fix. A geographical location that serves as a reference for a holding procedure.

Holding procedure. A predetermined manoeuvre which keeps an aircraft within a specified airspace while awaiting further clearance.

Hot spot. A location on an aerodrome movement area with a history or potential risk of collision or runway incursion, and where heightened attention by pilots/drivers is necessary.

Human Factors principles. Principles which apply to aeronautical design, certification, training, operations and maintenance and which seek safe interface between the human and other system components by proper consideration to human performance.

Human performance. Human capabilities and limitations which have an impact on the safety and efficiency of aeronautical operations.

Identification. The situation which exists when the position indication of a particular aircraft is seen on a situation display and positively identified.

IFR. The symbol used to designate the instrument flight rules.

IFR flight. A flight conducted in accordance with the instrument flight rules.

IMC. The symbol used to designate instrument meteorological conditions.

INCERFA. The code word used to designate an uncertainty phase.

Incident. An occurrence, other than an accident, associated with the operation of an aircraft which affects or could affect the safety of operation.

Note.— The type of incidents which are of main interest to the International Civil Aviation Organization for accident prevention studies can be found at <http://www.icao.int/anb/aig>.

Independent parallel approaches. Simultaneous approaches to parallel or near-parallel instrument runways where radar separation minima between aircraft on adjacent extended runway centre lines are not prescribed.

Independent parallel departures. Simultaneous departures from parallel or near-parallel instrument runways.

Initial approach segment. That segment of an instrument approach procedure between the initial approach fix and the intermediate approach fix or, where applicable, the final approach fix or point.

Instrument approach operations. An approach and landing using instruments for navigation guidance based on an instrument approach procedure. There are two methods for executing instrument approach operations:

- a) a two-dimensional (2D) instrument approach operation, using lateral navigation guidance only; and
- b) a three-dimensional (3D) instrument approach operation, using both lateral and vertical navigation guidance.

Note.— Lateral and vertical navigation guidance refers to the guidance provided either by:

- a) a ground-based radio navigation aid; or
- b) computer-generated navigation data from ground-based, space-based, self-contained navigation aids or a combination of these.

Instrument approach procedure (IAP). A series of predetermined manoeuvres by reference to flight instruments with specified protection from obstacles from the initial approach fix, or where applicable, from the beginning of a defined arrival route to a point from which a landing can be completed and thereafter, if a landing is not completed, to a position at which holding or en-route obstacle clearance criteria apply. Instrument approach procedures are classified as follows:

Non-precision approach (NPA) procedure. An instrument approach procedure designed for 2D instrument approach operations Type A.

Note.— Non-precision approach procedures may be flown using a continuous descent final approach (CDFA) technique. CDFAs with advisory VNAV guidance calculated by on-board equipment (see PANS-OPS (Doc 8168), Volume I, Part I, Section 4, Chapter 1, paragraph 1.8.1) are considered 3D instrument approach operations. CDFAs with manual calculation of the required rate of descent are considered 2D instrument approach operations. For more information on CDFAs, refer to PANS-OPS (Doc 8168), Volume I, Part I, Section 4, Chapter 1, paragraphs 1.7 and 1.8.

Approach procedure with vertical guidance (APV). A performance-based navigation (PBN) instrument approach procedure designed for 3D instrument approach operations Type A.

Precision approach (PA) procedure. An instrument approach procedure based on navigation systems (ILS, MLS, GLS and SBAS Cat I) designed for 3D instrument approach operations Type A or B.

Note.— Refer to Annex 6 for instrument approach operation types.

Instrument meteorological conditions (IMC). Meteorological conditions expressed in terms of visibility, distance from cloud, and ceiling, less than the minima specified for visual meteorological conditions.

Note 1.— The specified minima for visual meteorological conditions are contained in Chapter 4 of Annex 2.

Note 2.— In a control zone, a VFR flight may proceed under instrument meteorological conditions if and as authorized by air traffic control.

ITP aircraft. An aircraft approved by the State of the Operator to conduct in-trail procedure (ITP).

ITP distance. The distance between the ITP aircraft and a reference aircraft as defined by:

- a) aircraft on the same track, the difference in distance to an aircraft calculated common point along a projection of each other's track; or
- b) aircraft on parallel tracks, the distance measured along the track of one of the aircraft using its calculated position and the point abeam the calculated position of the other aircraft.

Note.— Reference aircraft refers to one or two aircraft with ADS-B data that meet the ITP criteria described in 5.4.2.7 and are indicated to ATC by the ITP aircraft as part of the ITP clearance request.

Landing area. That part of a movement area intended for the landing or take-off of aircraft.

Level. A generic term relating to the vertical position of an aircraft in flight and meaning variously, height, altitude or flight level.

Location indicator. A four-letter code group formulated in accordance with rules prescribed by ICAO and assigned to the location of an aeronautical fixed station.

Logon address: A specified code used for data link logon to an ATS unit.

Manoeuvring area. That part of an aerodrome to be used for the take-off, landing and taxiing of aircraft, excluding aprons.

Meteorological information. Meteorological report, analysis, forecast, and any other statement relating to existing or expected meteorological conditions.

Meteorological office. An office designated to provide meteorological service for international air navigation.

Meteorological report. A statement of observed meteorological conditions related to a specified time and location.

Minimum fuel. The term used to describe a situation in which an aircraft's fuel supply has reached a state where the flight is committed to land at a specific aerodrome and no additional delay can be accepted.

Missed approach procedure. The procedure to be followed if the approach cannot be continued.

Mode (SSR). The conventional identifier related to specific functions of the interrogation signals transmitted by an SSR interrogator. There are four modes specified in Annex 10: A, C, S and intermode.

Movement area. That part of an aerodrome to be used for the take-off, landing and taxiing of aircraft, consisting of the manoeuvring area and the apron(s).

Multilateration (MLAT) system. A group of equipment configured to provide position derived from the secondary surveillance radar (SSR) transponder signals (replies or squitters) primarily using time difference of arrival (TDOA) techniques. Additional information, including identification, can be extracted from the received signals.

Near-parallel runways. Non-intersecting runways whose extended centre lines have an angle of convergence/divergence of 15 degrees or less.

Next data authority. The ground system so designated by the current data authority through which an onward transfer of communications and control can take place.

Normal operating zone (NOZ). Airspace of defined dimensions extending to either side of an ILS localizer course and/or MLS final approach track. Only the inner half of the normal operating zone is taken into account in independent parallel approaches.

NOTAM. A notice distributed by means of telecommunication containing information concerning the establishment, condition or change in any aeronautical facility, service, procedure or hazard, the timely knowledge of which is essential to personnel concerned with flight operations.

No transgression zone (NTZ). In the context of independent parallel approaches, a corridor of airspace of defined dimensions located centrally between the two extended runway centre lines, where a penetration by an aircraft requires a controller intervention to manoeuvre any threatened aircraft on the adjacent approach.

Obstacle clearance altitude (OCA) or obstacle clearance height (OCH). The lowest altitude or the lowest height above the elevation of the relevant runway threshold or the aerodrome elevation as applicable, used in establishing compliance with appropriate obstacle clearance criteria.

Note 1.— Obstacle clearance altitude is referenced to mean sea level and obstacle clearance height is referenced to the threshold elevation or in the case of non-precision approach procedures to the aerodrome elevation or the threshold elevation if that is more than 2 m (7 ft) below the aerodrome elevation. An obstacle clearance height for a circling approach procedure is referenced to the aerodrome elevation.

Note 2.— For convenience when both expressions are used they may be written in the form “obstacle clearance altitude/height” and abbreviated “OCA/H”.

Operational control. The exercise of authority over the initiation, continuation, diversion or termination of a flight in the interest of the safety of the aircraft and the regularity and efficiency of the flight.

Operator. The person, organization or enterprise engaged in or offering to engage in an aircraft operation.

Performance-based communication (PBC). Communication based on performance specifications applied to the provision of air traffic services.

Note.— An RCP specification includes communication performance requirements that are allocated to system components in terms of the communication to be provided and associated transaction time, continuity, availability, integrity, safety and functionality needed for the proposed operation in the context of a particular airspace concept.

Performance-based navigation (PBN). Area navigation based on performance requirements for aircraft operating along an ATS route, on an instrument approach procedure or in a designated airspace.

Note.— Performance requirements are expressed in navigation specifications (RNAV specification, RNP specification) in terms of accuracy, integrity, continuity, availability and functionality needed for the proposed operation in the context of a particular airspace concept.

Performance-based surveillance (PBS). Surveillance based on performance specifications applied to the provision of air traffic services.

Note.— An RSP specification includes surveillance performance requirements that are allocated to system components in terms of the surveillance to be provided and associated data delivery time, continuity, availability, integrity, accuracy of the surveillance data, safety and functionality needed for the proposed operation in the context of a particular airspace concept.

Pilot-in-command. The pilot designated by the operator, or in the case of general aviation, the owner, as being in command and charged with the safe conduct of a flight.

Position indication. The visual indication, in non-symbolic and/or symbolic form, on a situation display, of the position of an aircraft, aerodrome vehicle or other object.

Position symbol. The visual indication in symbolic form, on a situation display, of the position of an aircraft, aerodrome vehicle or other object, obtained after automatic processing of positional data derived from any source.

Precision approach radar (PAR). Primary radar equipment used to determine the position of an aircraft during final approach, in terms of lateral and vertical deviations relative to a nominal approach path, and in range relative to touchdown.

Note.— Precision approach radars are designated to enable pilots of aircraft to be given guidance by radiocommunication during the final stages of the approach to land.

Pressure-altitude. An atmospheric pressure expressed in terms of altitude which corresponds to that pressure in the Standard Atmosphere.*

Primary radar. A radar system which uses reflected radio signals.

Primary surveillance radar (PSR). A surveillance radar system which uses reflected radio signals.

Procedural control. Term used to indicate that information derived from an ATS surveillance system is not required for the provision of air traffic control service.

Procedural separation. The separation used when providing procedural control.

Procedure turn. A manoeuvre in which a turn is made away from a designated track followed by a turn in the opposite direction to permit the aircraft to intercept and proceed along the reciprocal of the designated track.

Note 1.— Procedure turns are designated “left” or “right” according to the direction of the initial turn.

Note 2.— Procedure turns may be designated as being made either in level flight or while descending, according to the circumstances of each individual procedure.

Profile. The orthogonal projection of a flight path or portion thereof on the vertical surface containing the nominal track.

PSR blip. The visual indication, in non-symbolic form, on a situation display of the position of an aircraft obtained by primary radar.

Radar. A radio detection device which provides information on range, azimuth and/or elevation of objects.

Radar approach. An approach in which the final approach phase is executed under the direction of a controller using radar.

Radar clutter. The visual indication on a situation display of unwanted signals.

Radar contact. The situation which exists when the radar position of a particular aircraft is seen and identified on a situation display.

Radar separation. The separation used when aircraft position information is derived from radar sources.

Receiving unit/controller. Air traffic services unit/air traffic controller to which a message is sent.

Note.— See definition of “sending unit/controller”.

Repetitive flight plan (RPL). A flight plan related to a series of frequently recurring, regularly operated individual flights with identical basic features, submitted by an operator for retention and repetitive use by ATS units.

Reporting point. A specified geographical location in relation to which the position of an aircraft can be reported.

Required communication performance (RCP) specification. A set of requirements for air traffic service provision and associated ground equipment, aircraft capability, and operations needed to support performance-based communication.

Required surveillance performance (RSP) specification. A set of requirements for air traffic service provision and associated ground equipment, aircraft capability, and operations needed to support performance-based surveillance.

* As defined in Annex 8.

Required navigation performance (RNP). A statement of the navigation performance necessary for operation within a defined airspace.

Note.— *Navigation performance and requirements are defined for a particular RNP type and/or application.*

Rescue coordination centre. A unit responsible for promoting efficient organization of search and rescue services and for coordinating the conduct of search and rescue operations within a search and rescue region.

Rescue unit. A unit composed of trained personnel and provided with equipment suitable for the expeditious conduct of search and rescue.

RNP type. A containment value expressed as a distance in nautical miles from the intended position within which flights would be for at least 95 per cent of the total flying time.

Example.— RNP 4 represents a navigation accuracy of plus or minus 7.4 km (4 NM) on a 95 per cent containment basis.

Runway. A defined rectangular area on a land aerodrome prepared for the landing and take-off of aircraft.

Runway-holding position. A designated position intended to protect a runway, an obstacle limitation surface, or an ILS/MLS critical/sensitive area at which taxiing aircraft and vehicles shall stop and hold, unless otherwise authorized by the aerodrome control tower.

Note.— *In radiotelephony phraseologies, the expression “holding point” is used to designate the runway-holding position.*

Runway incursion. Any occurrence at an aerodrome involving the incorrect presence of an aircraft, vehicle or person on the protected area of a surface designated for the landing and take-off of aircraft.

Runway visual range (RVR). The range over which the pilot of an aircraft on the centre line of a runway can see the runway surface markings or the lights delineating the runway or identifying its centre line.

Safety management system (SMS). A systematic approach to managing safety, including the necessary organizational structures, accountability, responsibilities, policies and procedures.

Secondary radar. A radar system wherein a radio signal transmitted from the radar station initiates the transmission of a radio signal from another station.

Secondary surveillance radar (SSR). A surveillance radar system which uses transmitters/receivers (interrogators) and transponders.

Segregated parallel operations. Simultaneous operations on parallel or near-parallel instrument runways in which one runway is used exclusively for approaches and the other runway is used exclusively for departures.

Sending unit/controller. Air traffic services unit/air traffic controller transmitting a message.

Note.— *See definition of “receiving unit/controller”.*

Shoreline. A line following the general contour of the shore, except that in cases of inlets or bays less than 30 nautical miles in width, the line shall pass directly across the inlet or bay to intersect the general contour on the opposite side.

SIGMET information. Information issued by a meteorological watch office concerning the occurrence or expected occurrence of specified en-route weather and other phenomena in the atmosphere that may affect the safety of aircraft operations.

Significant point. A specified geographical location used in defining an ATS route or the flight path of an aircraft and for other navigation and ATS purposes.

Note.— There are three categories of significant points: ground-based navigation aid, intersection and waypoint. In the context of this definition, intersection is a significant point expressed as radials, bearings and/or distances from ground-based navigation aids.

Situation display. An electronic display depicting the position and movement of aircraft and other information as required.

Slush. Water-saturated snow which with a heel-and-toe slap-down motion against the ground will be displaced with a splatter; specific gravity: 0.5 up to 0.8.

Note.— Combinations of ice, snow and/or standing water may, especially when rain, rain and snow, or snow is falling, produce substances with specific gravities in excess of 0.8. These substances, due to their high water/ice content, will have a transparent rather than a cloudy appearance and, at the higher specific gravities, will be readily distinguishable from slush.

Snow (on the ground).

- a) *Dry snow.* Snow which can be blown if loose or, if compacted by hand, will fall apart upon release; specific gravity: up to but not including 0.35.
- b) *Wet snow.* Snow which, if compacted by hand, will stick together and tend to or form a snowball; specific gravity: 0.35 up to but not including 0.5.
- c) *Compacted snow.* Snow which has been compressed into a solid mass that resists further compression and will hold together or break up into lumps if picked up; specific gravity: 0.5 and over.

Special VFR flight. A VFR flight cleared by air traffic control to operate within a control zone in meteorological conditions below VMC.

SSR response. The visual indication, in non-symbolic form, on a situation display, of a response from an SSR transponder in reply to an interrogation.

Standard instrument arrival (STAR). A designated instrument flight rule (IFR) arrival route linking a significant point, normally on an ATS route, with a point from which a published instrument approach procedure can be commenced.

Standard instrument departure (SID). A designated instrument flight rule (IFR) departure route linking the aerodrome or a specified runway of the aerodrome with a specified significant point, normally on a designated ATS route, at which the en-route phase of a flight commences.

Standard message element. Part of a message defined in the PANS-ATM (Doc 4444) in terms of display format, intended use and attributes.

Stopway. A defined rectangular area on the ground at the end of take-off run available prepared as a suitable area in which an aircraft can be stopped in the case of an abandoned take-off.

Surveillance radar. Radar equipment used to determine the position of an aircraft in range and azimuth.

Taxiing. Movement of an aircraft on the surface of an aerodrome under its own power, excluding take-off and landing.

Taxiway. A defined path on a land aerodrome established for the taxiing of aircraft and intended to provide a link between one part of the aerodrome and another, including:

- a) *Aircraft stand taxilane.* A portion of an apron designated as a taxiway and intended to provide access to aircraft stands only.

- b) *Apron taxiway.* A portion of a taxiway system located on an apron and intended to provide a through taxi route across the apron.
- c) *Rapid exit taxiway.* A taxiway connected to a runway at an acute angle and designed to allow landing aeroplanes to turn off at higher speeds than are achieved on other exit taxiways thereby minimizing runway occupancy times.

Terminal control area (TMA). A control area normally established at the confluence of ATS routes in the vicinity of one or more major aerodromes.

Threshold. The beginning of that portion of the runway usable for landing.

Time difference of arrival (TDOA). The difference in relative time that a transponder signal from the same aircraft (or ground vehicle) is received at different receivers.

Total estimated elapsed time. For IFR flights, the estimated time required from take-off to arrive over that designated point, defined by reference to navigation aids, from which it is intended that an instrument approach procedure will be commenced, or, if no navigation aid is associated with the destination aerodrome, to arrive over the destination aerodrome. For VFR flights, the estimated time required from take-off to arrive over the destination aerodrome.

Touchdown. The point where the nominal glide path intercepts the runway.

Note.— “Touchdown” as defined above is only a datum and is not necessarily the actual point at which the aircraft will touch the runway.

Track. The projection on the earth’s surface of the path of an aircraft, the direction of which path at any point is usually expressed in degrees from North (true, magnetic or grid).

Traffic avoidance advice. Advice provided by an air traffic services unit specifying manoeuvres to assist a pilot to avoid a collision.

Traffic information. Information issued by an air traffic services unit to alert a pilot to other known or observed air traffic which may be in proximity to the position or intended route of flight and to help the pilot avoid a collision.

Transfer of control point. A defined point located along the flight path of an aircraft, at which the responsibility for providing air traffic control service to the aircraft is transferred from one control unit or control position to the next.

Transferring unit/controller. Air traffic control unit/air traffic controller in the process of transferring the responsibility for providing air traffic control service to an aircraft to the next air traffic control unit/air traffic controller along the route of flight.

Note.— See definition of “accepting unit/controller”.

Transition altitude. The altitude at or below which the vertical position of an aircraft is controlled by reference to altitudes.

Transition layer. The airspace between the transition altitude and the transition level.

Transition level. The lowest flight level available for use above the transition altitude.

Uncertainty phase. A situation wherein uncertainty exists as to the safety of an aircraft and its occupants.

Unmanned free balloon. A non-power-driven, unmanned, lighter-than-air aircraft in free flight.

Note.— Unmanned free balloons are classified as heavy, medium or light in accordance with specifications contained in Annex 2, Appendix 5.

Vectoring. Provision of navigational guidance to aircraft in the form of specific headings, based on the use of an ATS surveillance system.

VFR. The symbol used to designate the visual flight rules.

VFR flight. A flight conducted in accordance with the visual flight rules.

Visibility. Visibility for aeronautical purposes is the greater of:

- a) the greatest distance at which a black object of suitable dimensions, situated near the ground, can be seen and recognized when observed against a bright background;
- b) the greatest distance at which lights in the vicinity of 1 000 candelas can be seen and identified against an unlit background.

Note 1.— The two distances have different values in air of a given extinction coefficient, and the latter b) varies with the background illumination. The former a) is represented by the meteorological optical range (MOR).

Note 2.— The definition applies to the observations of visibility in local routine and special reports, to the observations of prevailing and minimum visibility reported in METAR and SPECI and to the observations of ground visibility.

Visual approach. An approach by an IFR flight when either part or all of an instrument approach procedure is not completed and the approach is executed in visual reference to terrain.

Visual meteorological conditions. Meteorological conditions expressed in terms of visibility, distance from cloud, and ceiling, equal to or better than specified minima.

Note.— The specified minima are contained in Annex 2, Chapter 4.

VMC. The symbol used to designate visual meteorological conditions.

Waypoint. A specified geographical location used to define an area navigation route or the flight path of an aircraft employing area navigation. Waypoints are identified as either:

Fly-by waypoint. A waypoint which requires turn anticipation to allow tangential interception of the next segment of a route or procedure, or

Flyover waypoint. A waypoint at which a turn is initiated in order to join the next segment of a route or procedure.

Chapter 2

ATS SAFETY MANAGEMENT

2.1 GENERAL

2.1.1 States shall ensure that the level of air traffic services (ATS) and communications, navigation and surveillance, as well as the ATS procedures applicable to the airspace or aerodrome concerned, are appropriate and adequate for maintaining an acceptable level of safety in the provision of ATS.

2.1.2 The requirements in respect of services, systems and procedures applicable to airspaces and aerodromes should be established on the basis of a regional air navigation agreement in order to facilitate the harmonization of ATS in adjacent airspaces.

2.1.3 To ensure that safety in the provision of ATS is maintained, the appropriate ATS authority shall implement safety management systems (SMS) for the air traffic services under its jurisdiction. Where appropriate, ATS SMS should be established on the basis of a regional air navigation agreement.

2.2 OBJECTIVES

The objectives of ATS safety management are to ensure that:

- a) the established level of safety applicable to the provision of ATS within an airspace or at an aerodrome is met; and
- b) safety-related enhancements are implemented whenever necessary.

2.3 ATS SAFETY MANAGEMENT ACTIVITIES

2.3.1 An ATS SMS should include, *inter alia*, the following with respect to the provision of air traffic services:

- a) monitoring of overall safety levels and detection of any adverse trend;
- b) safety reviews of ATS units;
- c) safety assessments in respect of the planned implementation of airspace reorganizations, the introduction of new equipment systems or facilities, and new or changed ATS procedures; and
- d) a mechanism for identifying the need for safety enhancing measures.

2.3.2 All activities undertaken in an ATS SMS shall be fully documented. All documentation shall be retained for such period of time as is specified by the appropriate authority.

2.4 MONITORING OF SAFETY LEVELS

2.4.1 Collection and evaluation of safety-related data

2.4.1.1 Data for use in safety monitoring programmes should be collected from as wide a range of sources as possible, as the safety-related consequences of particular procedures or systems may not be realized until after an incident has occurred.

2.4.1.2 The appropriate ATS authority should establish a formal incident reporting system for ATS personnel to facilitate the collection of information on actual or potential safety hazards or deficiencies related to the provision of ATS, including route structures, procedures, communications, navigation and surveillance systems and other safety significant systems and equipment as well as controller workloads.

Note.— Guidance related to both mandatory and voluntary State incident reporting systems is contained in the Safety Management Manual (SMM) (Doc 9859).

2.4.2 Review of incident and other safety-related reports

2.4.2.1 Safety-related reports concerning the operation of air traffic services, including air traffic incident reports, shall be systematically reviewed by the appropriate ATS authority in order to detect any adverse trend in the number and types of incidents which occur.

2.4.2.2 Reports concerning the serviceability of ATS facilities and systems, such as failures and degradations of communications, surveillance and other safety significant systems and equipment, shall be systematically reviewed by the appropriate ATS authority in order to detect any trend in the operation of such systems which may have an adverse effect on safety.

2.5 SAFETY REVIEWS

2.5.1 General requirements

Safety reviews of ATS units shall be conducted on a regular and systematic basis by personnel qualified through training, experience and expertise and having a full understanding of relevant Standards and Recommended Practices (SARPs), Procedures for Air Navigation Services (PANS), safe operating practices and Human Factors principles.

2.5.2 Scope

The scope of ATS unit safety reviews should include at least the following issues:

Regulatory issues to ensure that:

- a) ATS operations manuals, ATS unit instructions and air traffic control (ATC) coordination procedures are complete, concise and up-to-date;
- b) the ATS route structure, where applicable, provides for:
 - 1) adequate route spacing; and

- 2) crossing points for ATS routes located so as to reduce the need for controller intervention and for inter- and intra-unit coordination;
- c) the separation minima used in the airspace or at the aerodrome are appropriate and all the provisions applicable to those minima are being complied with;
- d) where applicable, provision is made for adequate observation of the manoeuvring area, and procedures and measures aimed at minimizing the potential for inadvertent runway incursions are in place. This observation may be performed visually or by means of an ATS surveillance system;
- e) appropriate procedures for low visibility aerodrome operations are in place;
- f) traffic volumes and associated controller workloads do not exceed defined, safe levels and that procedures are in place for regulating traffic volumes whenever necessary;
- g) procedures to be applied in the event of failures or degradations of ATS systems, including communications, navigation and surveillance systems, are practicable and will provide for an acceptable level of safety; and
- h) procedures for the reporting of incidents and other safety-related occurrences are implemented, that the reporting of incidents is encouraged and that such reports are reviewed to identify the need for any remedial action.

Operational and technical issues to ensure that:

- a) the environmental working conditions meet established levels for temperature, humidity, ventilation, noise and ambient lighting, and do not adversely affect controller performance;
- b) automation systems generate and display flight plan, control and coordination data in a timely, accurate and easily recognizable manner and in accordance with Human Factors principles;
- c) equipment, including input/output devices for automation systems, are designed and positioned in the working position in accordance with ergonomic principles;
- d) communications, navigation, surveillance and other safety significant systems and equipment:
 - 1) are tested for normal operations on a routine basis;
 - 2) meet the required level of reliability and availability as defined by the appropriate authority;
 - 3) provide for the timely and appropriate detection and warning of system failures and degradations;
 - 4) include documentation on the consequences of system, subsystem and equipment failures and degradations;
 - 5) include measures to control the probability of failures and degradations; and
 - 6) include adequate backup facilities and/or procedures in the event of a system failure or degradation; and
- e) detailed records of systems and equipment serviceability are kept and periodically reviewed.

Note.— *In the context above, the terms reliability and availability have the following meanings:*

- 1) *Reliability. The probability that a device or system will function without failure over a specified time period or amount of usage; and*
- 2) *Availability. The ratio of percentage of the time that a system is operating correctly to the total time in that period.*

Licensing and training issues to ensure that:

- a) controllers are adequately trained and properly licensed with valid ratings;
- b) controller competency is maintained by adequate and appropriate refresher training, including the handling of aircraft emergencies and operations under conditions with failed and degraded facilities and systems;
- c) controllers, where the ATC unit/control sector is staffed by teams, are provided relevant and adequate training in order to ensure efficient teamwork;
- d) the implementation of new or amended procedures, and new or updated communications, surveillance and other safety significant systems and equipment is preceded by appropriate training and instruction;
- e) controller competency in the English language is satisfactory in relation to providing ATS to international air traffic; and
- f) standard phraseology is used.

2.6 SAFETY ASSESSMENTS

2.6.1 Need for safety assessments

2.6.1.1 A safety assessment shall be carried out in respect of proposals for significant airspace reorganizations, for significant changes in the provision of ATS procedures applicable to an airspace or an aerodrome, and for the introduction of new equipment, systems or facilities, such as:

- a) a reduced separation minimum to be applied within an airspace or at an aerodrome;
- b) a new operating procedure, including departure and arrival procedures, to be applied within an airspace or at an aerodrome;
- c) a reorganization of the ATS route structure;
- d) a resectorization of an airspace;
- e) physical changes to the layout of runways and/or taxiways at an aerodrome; and
- f) implementation of new communications, surveillance or other safety-significant systems and equipment, including those providing new functionality and/or capabilities.

Note 1.— A reduced separation minimum may refer to the reduction of a horizontal separation minimum, including a minimum based on required navigation performance (RNP), a reduced vertical separation minimum of 300 m (1 000 ft) between FL 290 and FL 410 inclusive (RVSM), the reduction of a separation minimum based on the use of an ATS surveillance system or a wake turbulence separation minimum or reduction of minima between landing and/or departing aircraft.

Note 2.— When, due to the nature of the change, the acceptable level of safety cannot be expressed in quantitative terms, the safety assessments may rely on operational judgement.

2.6.1.2 Proposals shall be implemented only when the assessment has shown that an acceptable level of safety will be met.

2.6.2 Safety-significant factors

The safety assessment shall consider relevant all factors determined to be safety-significant, including:

- a) types of aircraft and their performance characteristics, including aircraft navigation capabilities and navigation performance;
- b) traffic density and distribution;
- c) airspace complexity, ATS route structure and classification of the airspace;
- d) aerodrome layout, including runway configurations, runway lengths and taxiway configurations;
- e) type of air-ground communications and time parameters for communication dialogues, including controller intervention capability;
- f) type and capabilities of surveillance system, and the availability of systems providing controller support and alert functions. Where ADS-B implementation envisages reliance upon a common source for surveillance and/or navigation, the safety assessment shall take account of adequate contingency measures to mitigate the risk of either degradation or loss of this common source (i.e. common mode failure); and
- g) any significant local or regional weather phenomena.

Note 1.— See also Chapter 5, Section 5.11, concerning reductions in separation minima.

Note 2.— Guidance material on methods of expressing and assessing a safety level and on safety monitoring programmes is contained in Annex 11, Attachment B, the Air Traffic Services Planning Manual (Doc 9426), the Manual on a 300 m (1 000 ft) Vertical Separation Minimum Between FL 290 and FL 410 Inclusive (Doc 9574), the Performance-based Navigation (PBN) Manual (Doc 9613) and the Manual on Airspace Planning Methodology for the Determination of Separation Minima (Doc 9689).

2.7 SAFETY-ENHANCING MEASURES

2.7.1 Any actual or potential hazard related to the provision of ATS within an airspace or at an aerodrome, whether identified through an ATS safety management activity or by any other means, shall be assessed and classified by the appropriate ATS authority for its risk acceptability.

2.7.2 Except when the risk can be classified as acceptable, the ATS authority concerned shall, as a matter of priority and as far as practicable, implement appropriate measures to eliminate the risk or reduce the risk to a level that is acceptable.

2.7.3 If it becomes apparent that the level of safety applicable to an airspace or an aerodrome is not, or may not be achieved, the appropriate ATS authority shall, as a matter of priority and as far as practicable, implement appropriate remedial measures.

2.7.4 Implementation of any remedial measure shall be followed by an evaluation of the effectiveness of the measure in eliminating or mitigating a risk.

Chapter 3

ATS SYSTEM CAPACITY AND AIR TRAFFIC FLOW MANAGEMENT

3.1 CAPACITY MANAGEMENT

3.1.1 General

3.1.1.1 The capacity of an ATS system depends on many factors, including the ATS route structure, the navigation accuracy of the aircraft using the airspace, weather-related factors, and controller workload. Every effort should be made to provide sufficient capacity to cater to both normal and peak traffic levels; however, in implementing any measures to increase capacity, the responsible ATS authority shall ensure, in accordance with the procedures specified in Chapter 2, that safety levels are not jeopardized.

3.1.1.2 The number of aircraft provided with an ATC service shall not exceed that which can be safely handled by the ATC unit concerned under the prevailing circumstances. In order to define the maximum number of flights which can be safely accommodated, the appropriate ATS authority should assess and declare the ATC capacity for control areas, for control sectors within a control area and for aerodromes.

3.1.1.3 ATC capacity should be expressed as the maximum number of aircraft which can be accepted over a given period of time within the airspace or at the aerodrome concerned.

Note.— The most appropriate measure of capacity is likely to be the sustainable hourly traffic flow. Such hourly capacities can, for example, be converted into daily, monthly or annual values.

3.1.2 Capacity assessment

In assessing capacity values, factors to be taken into account should include, *inter alia*:

- a) the level and type of ATS provided;
- b) the structural complexity of the control area, the control sector or the aerodrome concerned;
- c) controller workload, including control and coordination tasks to be performed;
- d) the types of communications, navigation and surveillance systems in use, their degree of technical reliability and availability as well as the availability of backup systems and/or procedures;
- e) availability of ATC systems providing controller support and alert functions; and
- f) any other factor or element deemed relevant to controller workload.

Note.— Summaries of techniques which may be used to estimate control sector/position capacities are contained in the Air Traffic Services Planning Manual (Doc 9426).

3.1.3 Regulation of ATC capacity and traffic volumes

3.1.3.1 Where traffic demand varies significantly on a daily or periodic basis, facilities and procedures should be implemented to vary the number of operational sectors or working positions to meet the prevailing and anticipated demand. Applicable procedures should be contained in local instructions.

3.1.3.2 In case of particular events which have a negative impact on the declared capacity of an airspace or aerodrome, the capacity of the airspace or aerodrome concerned shall be reduced accordingly for the required time period. Whenever possible, the capacity pertaining to such events should be predetermined.

3.1.3.3 To ensure that safety is not compromised whenever the traffic demand in an airspace or at an aerodrome is forecast to exceed the available ATC capacity, measures shall be implemented to regulate traffic volumes accordingly.

3.1.4 Enhancement of ATC capacity

3.1.4.1 The appropriate ATS authority should:

- a) periodically review ATS capacities in relation to traffic demand; and
- b) provide for flexible use of airspace in order to improve the efficiency of operations and increase capacity.

3.1.4.2 In the event that traffic demand regularly exceeds ATC capacity, resulting in continuing and frequent traffic delays, or it becomes apparent that forecast traffic demand will exceed capacity values, the appropriate ATS authority should, as far as practicable:

- a) implement steps aimed at maximizing the use of the existing system capacity; and
- b) develop plans to increase capacity to meet the actual or forecast demand.

3.1.5 Flexible use of airspace

3.1.5.1 The appropriate authorities should, through the establishment of agreements and procedures, make provision for the flexible use of all airspace in order to increase airspace capacity and to improve the efficiency and flexibility of aircraft operations. When applicable, such agreements and procedures should be established on the basis of a regional air navigation agreement.

3.1.5.2 Agreements and procedures providing for a flexible use of airspace should specify, *inter alia*:

- a) the horizontal and vertical limits of the airspace concerned;
- b) the classification of any airspace made available for use by civil air traffic;
- c) units or authorities responsible for transfer of the airspace;
- d) conditions for transfer of the airspace to the ATC unit concerned;
- e) conditions for transfer of the airspace from the ATC unit concerned;
- f) periods of availability of the airspace;
- g) any limitations on the use of the airspace concerned; and
- h) any other relevant procedures or information.

3.2 AIR TRAFFIC FLOW MANAGEMENT

3.2.1 General

3.2.1.1 An air traffic flow management (ATFM) service shall be implemented for airspace where traffic demand at times exceeds the defined ATC capacity.

3.2.1.2 ATFM should be implemented on the basis of a regional air navigation agreement or, when appropriate, as a multilateral agreement.

3.2.1.3 The ATFM service within a region or other defined area, should be developed and implemented as a centralized ATFM organization, supported by flow management positions established at each area control centre (ACC) within the region or area of applicability.

3.2.1.4 Certain flights may be exempt from ATFM measures, or be given priority over other flights.

3.2.1.5 Detailed procedures governing the provision of the ATFM measures, and service within a region or area should be prescribed in a regional ATFM manual or handbook.

3.2.2 Flow management procedures

ATFM should be carried out in three phases:

- a) *strategic planning*, if the action is carried out more than one day before the day on which it will take effect. Strategic planning is normally carried out well in advance, typically two to six months ahead;
- b) *pre-tactical planning*, if the action is to be taken on the day before the day on which it will take effect;
- c) *tactical operations*, if the action is taken on the day on which it will take effect.

3.2.3 Strategic planning

3.2.3.1 Strategic planning should be carried out in conjunction with ATC and the aircraft operators. It should consist of examining the demand for the forthcoming season, assessing where and when demand is likely to exceed the available ATC capacity and taking steps to resolve the imbalance by:

- a) arranging with the ATC authority to provide adequate capacity at the required place and time;
- b) re-routing certain traffic flows (traffic orientation);
- c) scheduling or rescheduling flights as appropriate; and
- d) identifying the need for tactical ATFM measures.

3.2.3.2 Where a traffic orientation scheme (TOS) is to be introduced, the routes should, as far as practicable, minimize the time and distance penalties for the flights concerned, and allow some degree of flexibility in the choice of routes, particularly for long-range flights.

3.2.3.3 When a TOS has been agreed, details should be published by all States concerned in a common format.

3.2.4 Pre-tactical planning

Pre-tactical planning should entail fine-tuning of the strategic plan in the light of updated demand data. During this phase:

- a) certain traffic flows may be re-routed;
- b) off-load routes may be coordinated;
- c) tactical measures will be decided upon; and
- d) details for the ATFM plan for the following day should be published and made available to all concerned.

3.2.5 Tactical operations

3.2.5.1 Tactical ATFM operations should consist of:

- a) executing the agreed tactical measures in order to provide a reduced and even flow of traffic where demand would otherwise have exceeded capacity;
- b) monitoring the evolution of the air traffic situation to ensure that the ATFM measures applied are having the desired effect and to take or initiate remedial action when long delays are reported, including re-routing of traffic and flight level allocation, in order to utilize the available ATC capacity to the maximum extent.

3.2.5.2 When the traffic demand exceeds, or is foreseen to exceed, the capacity of a particular sector or aerodrome, the responsible ATC unit shall advise the responsible ATFM unit, where such a unit is established, and other ATC units concerned. Flight crews of aircraft planned to fly in the affected area and operators should be advised, as soon as practicable, of the delays expected or the restrictions which will be applied.

Note.— Operators known or believed to be concerned will normally be advised by the regional air traffic flow management service, when established.

3.2.6 Liaison

During all phases of ATFM the responsible units should liaise closely with ATC and the aircraft operators in order to ensure an effective and equitable service.

Note.— Attention is drawn to the guidance material contained in the Air Traffic Services Planning Manual (Doc 9426) regarding flow control as well as to procedures contained in the Regional Supplementary Procedures (Doc 7030) and regional ATFM Handbooks.

Chapter 4

GENERAL PROVISIONS FOR AIR TRAFFIC SERVICES

4.1 RESPONSIBILITY FOR THE PROVISION OF AIR TRAFFIC CONTROL SERVICE

4.1.1 Area control service

Area control service shall be provided:

- a) by an area control centre (ACC); or
- b) by the unit providing approach control service in a control zone or in a control area of limited extent which is designated primarily for the provision of approach control service, when no ACC is established.

4.1.2 Approach control service

Approach control service shall be provided:

- a) by an aerodrome control tower or an ACC, when it is necessary or desirable to combine under the responsibility of one unit the functions of the approach control service and those of the aerodrome control service or the area control service; or
- b) by an approach control unit, when it is necessary or desirable to establish a separate unit.

Note.— Approach control service may be provided by a unit collocated with an ACC, or by a control sector within an ACC.

4.1.3 Aerodrome control service

Aerodrome control service shall be provided by an aerodrome control tower.

4.2 RESPONSIBILITY FOR THE PROVISION OF FLIGHT INFORMATION SERVICE AND ALERTING SERVICE

Flight information service and alerting service shall be provided as follows:

- a) *within a flight information region (FIR):* by a flight information centre, unless the responsibility for providing such services is assigned to an air traffic control unit having adequate facilities for the exercise of such responsibilities;
- b) *within controlled airspace and at controlled aerodromes:* by the relevant air traffic control units.

4.3 DIVISION OF RESPONSIBILITY FOR CONTROL BETWEEN AIR TRAFFIC CONTROL UNITS

4.3.1 General

The appropriate ATS authority shall designate the area of responsibility for each air traffic control (ATC) unit and, when applicable, for individual control sectors within an ATC unit. Where there is more than one ATC working position within a unit or sector, the duties and responsibilities of the individual working positions shall be defined.

4.3.2 Between a unit providing aerodrome control service and a unit providing approach control service

4.3.2.1 Except for flights which are provided aerodrome control service only, the control of arriving and departing controlled flights shall be divided between units providing aerodrome control service and units providing approach control service as follows:

4.3.2.1.1 *Arriving aircraft.* Control of an arriving aircraft shall be transferred from the unit providing approach control service to the unit providing aerodrome control service when the aircraft:

- a) is in the vicinity of the aerodrome, and
 - 1) it is considered that approach and landing will be completed in visual reference to the ground, or
 - 2) has reached uninterrupted visual meteorological conditions, or
- b) is at a prescribed point or level, or
- c) has landed,

as specified in letters of agreement or ATS unit instructions.

4.3.2.1.2 Transfer of communications to the aerodrome controller should be effected at such a point, level or time that clearance to land or alternative instructions, as well as information on essential local traffic, can be issued in a timely manner.

Note.— Even though there is an approach control unit, control of certain flights may be transferred directly from an ACC to an aerodrome control tower and vice versa, by prior arrangement between the units concerned for the relevant part of approach control service to be provided by the ACC or the aerodrome control tower, as applicable.

4.3.2.1.3 *Departing aircraft.* Control of a departing aircraft shall be transferred from the unit providing aerodrome control service to the unit providing approach control service:

- a) when visual meteorological conditions prevail in the vicinity of the aerodrome:
 - 1) prior to the time the aircraft leaves the vicinity of the aerodrome,
 - 2) prior to the aircraft entering instrument meteorological conditions, or
 - 3) when the aircraft is at a prescribed point or level,

as specified in letters of agreement or ATS unit instructions;

b) when instrument meteorological conditions prevail at the aerodrome:

- 1) immediately after the aircraft is airborne, or
- 2) when the aircraft is at a prescribed point or level,

as specified in letters of agreement or local instructions.

Note.— See Note following 4.3.2.1.2.

4.3.3 Between a unit providing approach control service and a unit providing area control service

4.3.3.1 When area control service and approach control service are not provided by the same air traffic control unit, responsibility for controlled flights shall rest with the unit providing area control service except that a unit providing approach control service shall be responsible for the control of:

- a) arriving aircraft that have been released to it by the ACC;
- b) departing aircraft until such aircraft are released to the ACC.

4.3.3.2 A unit providing approach control service shall assume control of arriving aircraft, provided such aircraft have been released to it, upon arrival of the aircraft at the point, level or time agreed for transfer of control, and shall maintain control during approach to the aerodrome.

4.3.4 Between two units providing area control service

The responsibility for the control of an aircraft shall be transferred from a unit providing area control service in a control area to the unit providing area control service in an adjacent control area at the time of crossing the common control area boundary as estimated by the ACC having control of the aircraft or at such other point, level or time as has been agreed between the two units.

4.3.5 Between control sectors/positions within the same air traffic control unit

The responsibility for the control of an aircraft shall be transferred from one control sector/position to another control sector/position within the same ATC unit at a point, level or time, as specified in local instructions.

4.4 FLIGHT PLAN

4.4.1 Flight plan form

Note.— Procedures for the use of repetitive flight plans are contained in Chapter 16, Section 16.4.

4.4.1.1 A flight plan form based on the model in Appendix 2 should be provided and should be used by operators and air traffic services units for the purpose of completing flight plans.

Note.— A different form may be provided for use in completing repetitive flight plan listings.

4.4.1.2 The flight plan form should be printed and should include an English text in addition to the language(s) of the State concerned.

Note.— The Model Flight Plan Form in Appendix 2 is printed in English and one other of the languages of the Organization for illustration purposes.

4.4.1.3 Operators and air traffic services units should comply with:

- a) the instructions for completion of the flight plan form and the repetitive flight plan listing form given in Appendix 2; and
- b) any constraints identified in relevant Aeronautical Information Publications (AIPs).

Note 1.— Failure to adhere to the provisions of Appendix 2 or any constraint identified in relevant AIPs may result in data being rejected, processed incorrectly or lost.

Note 2.— The instructions for completing the flight plan form given in Appendix 2 may be conveniently printed on the inside cover of flight plan form pads, or posted in briefing rooms.

4.4.1.4 An operator shall, prior to departure:

- a) ensure that, where the flight is intended to operate on a route or in an area where a navigation specification is prescribed, it has an appropriate RNP approval, and that all conditions applying to that approval will be satisfied;
- b) ensure that, where the flight is intended to operate in reduced vertical separation minimum (RVSM) airspace, it has the required RVSM approval;
- c) ensure that, where the flight is intended to operate where an RCP specification is prescribed, it has an appropriate approval, and that all conditions applying to that approval will be satisfied.
- d) ensure that, where the flight is intended to operate where an RSP specification is prescribed, it has an appropriate RSP approval, and that all conditions applying to that approval will be satisfied.

4.4.2 Submission of a flight plan

4.4.2.1 PRIOR TO DEPARTURE

4.4.2.1.1 Flight plans shall not be submitted more than 120 hours before the estimated off-block time of a flight.

4.4.2.1.2 Except when other arrangements have been made for submission of repetitive flight plans, a flight plan submitted prior to departure should be submitted to the air traffic services reporting office at the departure aerodrome. If no such unit exists at the departure aerodrome, the flight plan should be submitted to the unit serving or designated to serve the departure aerodrome.

4.4.2.1.3 In the event of a delay of 30 minutes in excess of the estimated off-block time for a controlled flight or a delay of one hour for an uncontrolled flight for which a flight plan has been submitted, the flight plan should be amended or a new flight plan submitted and the old flight plan cancelled, whichever is applicable.

4.4.2.2 DURING FLIGHT

4.4.2.2.1 A flight plan to be submitted during flight should normally be transmitted to the ATS unit in charge of the FIR, control area, advisory area or advisory route in or on which the aircraft is flying, or in or through which the aircraft

wishes to fly or to the aeronautical telecommunication station serving the air traffic services unit concerned. When this is not practicable, it should be transmitted to another ATS unit or aeronautical telecommunication station for retransmission as required to the appropriate air traffic services unit.

4.4.2.2.2 Where relevant, such as in respect of ATC units serving high- or medium-density airspace, the appropriate ATS authority should prescribe conditions and/or limitations with respect to the submission of flight plans during flight to ATC units.

Note.— If the flight plan is submitted for the purpose of obtaining air traffic control service, the aircraft is required to wait for an air traffic control clearance prior to proceeding under the conditions requiring compliance with air traffic control procedures. If the flight plan is submitted for the purpose of obtaining air traffic advisory service, the aircraft is required to wait for acknowledgment of receipt by the unit providing the service.

4.4.3 Acceptance of a flight plan

The first ATS unit receiving a flight plan, or change thereto, shall:

- a) check it for compliance with the format and data conventions;
- b) check it for completeness and, to the extent possible, for accuracy;
- c) take action, if necessary, to make it acceptable to the air traffic services; and
- d) indicate acceptance of the flight plan or change thereto, to the originator.

4.5 AIR TRAFFIC CONTROL CLEARANCES

4.5.1 Scope and purpose

4.5.1.1 Clearances are issued solely for expediting and separating air traffic and are based on known traffic conditions which affect safety in aircraft operation. Such traffic conditions include not only aircraft in the air and on the manoeuvring area over which control is being exercised, but also any vehicular traffic or other obstructions not permanently installed on the manoeuvring area in use.

4.5.1.2 If an air traffic control clearance is not suitable to the pilot-in-command of an aircraft, the flight crew may request and, if practicable, obtain an amended clearance.

4.5.1.3 The issuance of air traffic control clearances by air traffic control units constitutes authority for an aircraft to proceed only in so far as known air traffic is concerned. ATC clearances do not constitute authority to violate any applicable regulations for promoting the safety of flight operations or for any other purpose; neither do clearances relieve a pilot-in-command of any responsibility whatsoever in connection with a possible violation of applicable rules and regulations.

4.5.1.4 ATC units shall issue such ATC clearances as are necessary to prevent collisions and to expedite and maintain an orderly flow of air traffic.

4.5.1.5 ATC clearances must be issued early enough to ensure that they are transmitted to the aircraft in sufficient time for it to comply with them.

4.5.2 Aircraft subject to ATC for part of flight

4.5.2.1 When a flight plan specifies that the initial portion of a flight will be uncontrolled, and that the subsequent portion of the flight will be subject to ATC, the aircraft shall be advised to obtain its clearance from the ATC unit in whose area controlled flight will be commenced.

4.5.2.2 When a flight plan specifies that the first portion of a flight will be subject to ATC, and that the subsequent portion will be uncontrolled, the aircraft shall normally be cleared to the point at which the controlled flight terminates.

4.5.3 Flights through intermediate stops

4.5.3.1 When an aircraft files, at the departure aerodrome, flight plans for the various stages of flight through intermediate stops, the initial clearance limit will be the first destination aerodrome and new clearances shall be issued for each subsequent portion of flight.

4.5.3.2 The flight plan for the second stage, and each subsequent stage, of a flight through intermediate stops will become active for ATS and search and rescue (SAR) purposes only when the appropriate ATS unit has received notification that the aircraft has departed from the relevant departure aerodrome, except as provided for in 4.5.3.3.

4.5.3.3 By prior arrangement between ATC units and the operators, aircraft operating on an established schedule may, if the proposed route of flight is through more than one control area, be cleared through intermediate stops within other control areas but only after coordination between the ACCs concerned.

4.5.4 Contents of clearances

4.5.4.1 Clearances shall contain positive and concise data and shall, as far as practicable, be phrased in a standard manner.

4.5.4.2 Clearances shall, except as provided for in Chapter 6, Section 6.3.2, concerning standard departure clearances, contain the items specified in Chapter 11, 11.4.2.6.2.1.

4.5.5 Departing aircraft

ACCs shall, except where procedures providing for the use of standard departure clearances have been implemented, forward a clearance to approach control units or aerodrome control towers with the least possible delay after receipt of request made by these units, or prior to such request if practicable.

4.5.6 En-route aircraft

4.5.6.1 GENERAL

4.5.6.1.1 An ATC unit may request an adjacent ATC unit to clear aircraft to a specified point during a specified period.

4.5.6.1.2 After the initial clearance has been issued to an aircraft at the point of departure, it will be the responsibility of the appropriate ATC unit to issue an amended clearance whenever necessary and to issue traffic information, if required.

4.5.6.1.3 When so requested by the flight crew, an aircraft shall be cleared for cruise climb whenever traffic conditions and coordination procedures permit. Such clearance shall be for cruise climb either above a specified level or between specified levels.

4.5.6.2 CLEARANCES RELATING TO SUPERSONIC FLIGHT

4.5.6.2.1 Aircraft intending supersonic flight shall, whenever practicable, be cleared for the transonic acceleration phase prior to departure.

4.5.6.2.2 During the transonic and supersonic phases of a flight, amendments to the clearance should be kept to a minimum and must take due account of the operational limitations of the aircraft in these flight phases.

4.5.7 Description of air traffic control clearances

4.5.7.1 CLEARANCE LIMIT

4.5.7.1.1 A clearance limit shall be described by specifying the name of the appropriate significant point, or aerodrome, or controlled airspace boundary.

4.5.7.1.2 When prior coordination has been effected with units under whose control the aircraft will subsequently come, or if there is reasonable assurance that it can be effected a reasonable time prior to their assumption of control, the clearance limit shall be the destination aerodrome or, if not practicable, an appropriate intermediate point, and coordination shall be expedited so that a clearance to the destination aerodrome may be issued as soon as possible.

4.5.7.1.3 If an aircraft has been cleared to an intermediate point in adjacent controlled airspace, the appropriate ATC unit will then be responsible for issuing, as soon as practicable, an amended clearance to the destination aerodrome.

4.5.7.1.4 When the destination aerodrome is outside controlled airspace, the ATC unit responsible for the last controlled airspace through which an aircraft will pass shall issue the appropriate clearance for flight to the limit of that controlled airspace.

4.5.7.2 ROUTE OF FLIGHT

4.5.7.2.1 The route of flight shall be detailed in each clearance when deemed necessary. The phrase “cleared flight planned route” may be used to describe any route or portion thereof, provided the route or portion thereof is identical to that filed in the flight plan and sufficient routing details are given to definitely establish the aircraft on its route. The phrases “cleared (designation) departure” or “cleared (designation) arrival” may be used when standard departure or arrival routes have been established by the appropriate ATS authority and published in Aeronautical Information Publications (AIPs).

Note.— See 6.3.2.3 pertaining to standard clearances for departing aircraft and 6.5.2.3 pertaining to standard clearances for arriving aircraft.

4.5.7.2.2 The phrase “cleared flight planned route” shall not be used when granting a re-clearance.

4.5.7.2.3 Subject to airspace constraints, ATC workload and traffic density, and provided coordination can be effected in a timely manner, an aircraft should whenever possible be offered the most direct routing.

4.5.7.3 LEVELS

Except as provided for in Chapter 6, 6.3.2 and 6.5.1.5, use of standard departure and arrival clearances, instructions included in clearances relating to levels shall consist of the items specified in Chapter 11, 11.4.2.6.2.2.

4.5.7.4 CLEARANCE OF A REQUESTED CHANGE IN FLIGHT PLAN

4.5.7.4.1 When issuing a clearance covering a requested change in route or level, the exact nature of the change shall be included in the clearance.

4.5.7.4.2 When traffic conditions will not permit clearance of a requested change, the word “UNABLE” shall be used. When warranted by circumstances, an alternative route or level should be offered.

4.5.7.4.3 When an alternative route is offered and accepted by the flight crew under the procedures described in 4.5.7.4.2, the amended clearance issued shall describe the route to the point where it joins the previously cleared route, or, if the aircraft will not re-join the previous route, to the destination.

4.5.7.5 READBACK OF CLEARANCES

4.5.7.5.1 The flight crew shall read back to the air traffic controller safety-related parts of ATC clearances and instructions which are transmitted by voice. The following items shall always be read back:

- a) ATC route clearances;
- b) clearances and instructions to enter, land on, take off from, hold short of, cross, taxi and backtrack on any runway; and
- c) runway-in-use, altimeter settings, SSR codes, level instructions, heading and speed instructions and, whether issued by the controller or contained in automatic terminal information service (ATIS) broadcasts, transition levels.

Note.— If the level of an aircraft is reported in relation to standard pressure 1 013.2 hPa, the words “FLIGHT LEVEL” precede the level figures. If the level of the aircraft is reported in relation to QNH/QFE, the figures are followed by the word “METRES” or “FEET”, as appropriate.

4.5.7.5.1.1 Other clearances or instructions, including conditional clearances, shall be read back or acknowledged in a manner to clearly indicate that they have been understood and will be complied with.

4.5.7.5.2 The controller shall listen to the readback to ascertain that the clearance or instruction has been correctly acknowledged by the flight crew and shall take immediate action to correct any discrepancies revealed by the readback.

4.5.7.5.2.1 Unless specified by the appropriate ATS authority, voice readback of controller-pilot data link communications (CPDLC) messages shall not be required.

Note.— The procedures and provisions relating to the exchange and acknowledgement of CPDLC messages are contained in Annex 10, Volume II and the PANS-ATM, Chapter 14.

4.6 HORIZONTAL SPEED CONTROL INSTRUCTIONS

4.6.1 General

4.6.1.1 In order to facilitate a safe and orderly flow of traffic, aircraft may, subject to conditions specified by the appropriate authority, be instructed to adjust speed in a specified manner. Flight crews should be given adequate notice of planned speed control.

Note 1.— Application of speed control over a long period of time may affect aircraft fuel reserves.

Note 2.— Provisions concerning longitudinal separation using the Mach number technique are contained in Chapter 5, Separation Methods and Minima.

4.6.1.2 Speed control instructions shall remain in effect unless explicitly cancelled or amended by the controller.

Note.— Cancellation of any speed control instruction does not relieve the flight crew of compliance with speed limitations associated with airspace classifications as specified in Annex 11 — Air Traffic Services, Appendix 4.

4.6.1.3 Speed control shall not be applied to aircraft entering or established in a holding pattern.

4.6.1.4 Speed adjustments should be limited to those necessary to establish and/or maintain a desired separation minimum or spacing. Instructions involving frequent changes of speed, including alternate speed increases and decreases, should be avoided.

4.6.1.5 The flight crew shall inform the ATC unit concerned if at any time they are unable to comply with a speed instruction. In such cases, the controller shall apply an alternative method to achieve the desired spacing between the aircraft concerned.

4.6.1.6 At levels at or above 7 600 m (FL 250), speed adjustments should be expressed in multiples of 0.01 Mach; at levels below 7 600 m (FL 250), speed adjustments should be expressed in multiples of 20 km/h (10 kt) based on indicated airspeed (IAS).

Note 1.— Mach 0.01 equals approximately 11 km/h (6 kt) IAS at higher flight levels.

Note 2.— When an aircraft is heavily loaded and at a high level, its ability to change speed may, in cases, be very limited.

4.6.1.7 Aircraft shall be advised when a speed control restriction is no longer required.

4.6.2 Methods of application

4.6.2.1 In order to establish a desired spacing between two or more successive aircraft, the controller should first either reduce the speed of the last aircraft, or increase the speed of the lead aircraft, then adjust the speed(s) of the other aircraft in order.

4.6.2.2 In order to maintain a desired spacing using speed control techniques, specific speeds need to be assigned to all the aircraft concerned.

Note 1.— The true airspeed (TAS) of an aircraft will decrease during descent when maintaining a constant IAS. When two descending aircraft maintain the same IAS, and the leading aircraft is at the lower level, the TAS of the leading aircraft will be lower than that of the following aircraft. The distance between the two aircraft will thus be reduced, unless a sufficient speed differential is applied. For the purpose of calculating a desired speed differential between two succeeding aircraft, 11 km/h (6 kt) IAS per 300 m (1 000 ft) height difference may be used as a general rule. At levels below 2 450 m (FL 80) the difference between IAS and TAS is negligible for speed control purposes.

Note 2.— Time and distance required to achieve a desired spacing will increase with higher levels, higher speeds, and when the aircraft is in a clean configuration.

4.6.3 Descending and arriving aircraft

4.6.3.1 An aircraft should, when practicable, be authorized to absorb a period of notified terminal delay by cruising at a reduced speed for the latter portion of its flight.

4.6.3.2 An arriving aircraft may be instructed to maintain its “maximum speed”, “minimum clean speed”, “minimum speed”, or a specified speed.

Note.— “Minimum clean speed” signifies the minimum speed at which an aircraft can be flown in a clean configuration, i.e. without deployment of lift-augmentation devices, speed brakes or landing gear.

4.6.3.3 Speed reductions to less than 460 km/h (250 kt) IAS for turbojet aircraft during initial descent from cruising level should be applied only with the concurrence of the flight crew.

4.6.3.4 Instructions for an aircraft to simultaneously maintain a high rate of descent and reduce its speed should be avoided as such manoeuvres are normally not compatible. Any significant speed reduction during descent may require the aircraft to temporarily level off to reduce speed before continuing descent.

4.6.3.5 Arriving aircraft should be permitted to operate in a clean configuration for as long as possible. Below 4 550 m (FL 150), speed reductions for turbojet aircraft to not less than 410 km/h (220 kt) IAS, which will normally be very close to the minimum speed of turbojet aircraft in a clean configuration, may be used.

4.6.3.6 Only minor speed adjustments not exceeding plus/minus 40 km/h (20 kt) IAS should be used for aircraft on intermediate and final approach.

4.6.3.7 Speed control should not be applied to aircraft after passing a point 7 km (4 NM) from the threshold on final approach.

Note.— The flight crew has a requirement to fly a stabilized approach (airspeed and configuration) typically by 5 km (3 NM) from the threshold (Doc 8168, PANS-OPS, Volume I, Part III, Section 4, Chapter 3, 3.3 refers).

4.6.4 SID and STAR

The flight crew shall comply with published SID and STAR speed restrictions unless the restrictions are explicitly cancelled or amended by the controller.

Note. 1.— Some SID and STAR speed restrictions ensure containment within RNAV departure or arrival procedure (e.g. maximum speed associated with a constant radius arc to a fix (RF) leg).

Note 2.— See 6.3.2.4 pertaining to clearances on a SID and 6.5.2.4 pertaining to clearances on a STAR.

4.7 VERTICAL SPEED CONTROL INSTRUCTIONS

4.7.1 General

4.7.1.1 In order to facilitate a safe and orderly flow of traffic, aircraft may be instructed to adjust rate of climb or rate of descent. Vertical speed control may be applied between two climbing aircraft or two descending aircraft in order to establish or maintain a specific vertical separation minimum.

4.7.1.2 Vertical speed adjustments should be limited to those necessary to establish and/or maintain a desired separation minimum. Instructions involving frequent changes of climb/descent rates should be avoided.

4.7.1.3 The flight crew shall inform the ATC unit concerned if unable, at any time, to comply with a specified rate of climb or descent. In such cases, the controller shall apply an alternative method to achieve an appropriate separation minimum between aircraft, without delay.

4.7.1.4 Aircraft shall be advised when a rate of climb/descent restriction is no longer required.

4.7.2 Methods of application

4.7.2.1 An aircraft may be instructed to expedite climb or descent as appropriate to or through a specified level, or may be instructed to reduce its rate of climb or rate of descent.

4.7.2.2 Climbing aircraft may be instructed to maintain a specified rate of climb, a rate of climb equal to or greater than a specified value or a rate of climb equal to or less than a specified value.

4.7.2.3 Descending aircraft may be instructed to maintain a specified rate of descent, a rate of descent equal to or greater than a specified value or a rate of descent equal to or less than a specified value.

4.7.2.4 In applying vertical speed control, the controller should ascertain to which level(s) climbing aircraft can sustain a specified rate of climb or, in the case of descending aircraft, the specified rate of descent which can be sustained, and shall ensure that alternative methods of maintaining separation can be applied in a timely manner, if required.

Note.— Controllers need to be aware of aircraft performance characteristics and limitations in relation to a simultaneous application of horizontal and vertical speed limitations.

4.8 CHANGE FROM IFR TO VFR FLIGHT

4.8.1 Change from instrument flight rules (IFR) flight to visual flight rules (VFR) flight is only acceptable when a message initiated by the pilot-in-command containing the specific expression “CANCELLING MY IFR FLIGHT”, together with the changes, if any, to be made to the current flight plan, is received by an air traffic services unit. No invitation to change from IFR flight to VFR flight is to be made either directly or by inference.

4.8.2 No reply, other than the acknowledgment “IFR FLIGHT CANCELLED AT ... (time)”, should normally be made by an air traffic services unit.

4.8.3 When an ATS unit is in possession of information that instrument meteorological conditions are likely to be encountered along the route of flight, a pilot changing from IFR flight to VFR flight should, if practicable, be so advised.

Note.— See Chapter 11, 11.4.3.2.1.

4.8.4 An ATC unit receiving notification of an aircraft’s intention to change from IFR to VFR flight shall, as soon as practicable thereafter, so inform all other ATS units to whom the IFR flight plan was addressed, except those units through whose regions or areas the flight has already passed.

4.9 WAKE TURBULENCE CATEGORIES

Note.— The term “wake turbulence” is used in this context to describe the effect of the rotating air masses generated behind the wing tips of large jet aircraft, in preference to the term “wake vortex” which describes the nature of the air masses. Detailed characteristics of wake vortices and their effect on aircraft are contained in the Air Traffic Services Planning Manual (Doc 9426), Part II, Section 5.

4.9.1 Wake turbulence categories of aircraft

4.9.1.1 Wake turbulence separation minima shall be based on a grouping of aircraft types into three categories according to the maximum certificated take-off mass as follows:

- a) HEAVY (H) — all aircraft types of 136 000 kg or more;
- b) MEDIUM (M) — aircraft types less than 136 000 kg but more than 7 000 kg; and
- c) LIGHT (L) — aircraft types of 7 000 kg or less.

4.9.1.2 Helicopters should be kept well clear of light aircraft when hovering or while air taxiing.

Note 1.— Helicopters produce vortices when in flight and there is some evidence that, per kilogram of gross mass, their vortices are more intense than those of fixed-wing aircraft.

Note 2.— The provisions governing wake turbulence separation minima are set forth in Chapter 5, Section 5.8, and Chapter 8, Section 8.7.3.

4.9.2 Indication of heavy wake turbulence category

For aircraft in the heavy wake turbulence category the word “Heavy” shall be included immediately after the aircraft call sign in the initial radiotelephony contact between such aircraft and ATS units.

Note.— Wake turbulence categories are specified in the instructions for completing Item 9 of the flight plan in Appendix 2.

4.10 ALTIMETER SETTING PROCEDURES

4.10.1 Expression of vertical position of aircraft

4.10.1.1 For flights in the vicinity of aerodromes and within terminal control areas the vertical position of aircraft shall, except as provided for in 4.10.1.2, be expressed in terms of altitudes at or below the transition altitude and in terms of flight levels at or above the transition level. While passing through the transition layer, vertical position shall be expressed in terms of flight levels when climbing and in terms of altitudes when descending.

4.10.1.2 When an aircraft which has been given clearance to land is completing its approach using atmospheric pressure at aerodrome elevation (QFE), the vertical position of the aircraft shall be expressed in terms of height above aerodrome elevation during that portion of its flight for which QFE may be used, except that it shall be expressed in terms of height above runway threshold elevation:

- a) for instrument runways, if the threshold is 2 m (7 ft) or more below the aerodrome elevation; and
- b) for precision approach runways.

4.10.1.3 For flights en route, the vertical position of aircraft shall be expressed in terms of:

- a) flight levels at or above the lowest usable flight level; and
- b) altitudes below the lowest usable flight level;

except where, on the basis of regional air navigation agreements, a transition altitude has been established for a specified area, in which case the provisions of 4.10.1.1 shall apply.

4.10.2 Determination of the transition level

4.10.2.1 The appropriate ATS unit shall establish the transition level to be used in the vicinity of the aerodrome(s) concerned and, when relevant, the terminal control area (TMA) concerned, for the appropriate period of time on the basis of QNH (altimeter subscale setting to obtain elevation when on the ground) reports and forecast mean sea level pressure, if required.

4.10.2.2 The transition level shall be the lowest flight level available for use above the transition altitude established for the aerodrome(s) concerned. Where a common transition altitude has been established for two or more aerodromes which are so closely located as to require coordinated procedures, the appropriate ATS units shall establish a common transition level to be used at any given time in the vicinity of the aerodrome and, when relevant, in the TMA concerned.

Note.— See 4.10.3.2 regarding the determination of the lowest usable flight level(s) for control areas.

4.10.3 Minimum cruising level for IFR flights

4.10.3.1 Except when specifically authorized by the appropriate authority, cruising levels below the minimum flight altitudes established by the State shall not be assigned.

4.10.3.2 ATC units shall, when circumstances warrant it, determine the lowest usable flight level or levels for the whole or parts of the control area for which they are responsible, use it when assigning flight levels and pass it to pilots on request.

Note 1.— Unless otherwise prescribed by the State concerned, the lowest usable flight level is that flight level which corresponds to, or is immediately above, the established minimum flight altitude.

Note 2.— The portion of a control area for which a particular lowest usable flight level applies is determined in accordance with air traffic services requirements.

Note 3.— The objectives of the air traffic control service as prescribed in Annex 11 do not include prevention of collision with terrain. The procedures prescribed in this document do not relieve pilots of their responsibility to ensure that any clearances issued by air traffic control units are safe in this respect. When an IFR flight is vectored or is given a direct routing which takes the aircraft off an ATS route, the procedures in Chapter 8, 8.6.5.2 apply.

4.10.4 Provision of altimeter setting information

4.10.4.1 Appropriate ATS units shall at all times have available for transmission to aircraft in flight, on request, the information required to determine the lowest flight level which will ensure adequate terrain clearance on routes or segments of routes for which this information is required.

Note.— If so prescribed on the basis of regional air navigation agreements, this information may consist of climatological data.

4.10.4.2 Flight information centres and ACCs shall have available for transmission to aircraft, on request, an appropriate number of QNH reports or forecast pressures for the FIRs and control areas for which they are responsible, and for those adjacent.

4.10.4.3 The flight crew shall be provided with the transition level in due time prior to reaching it during descent. This may be accomplished by voice communications, ATIS broadcast or data link.

4.10.4.4 The transition level shall be included in approach clearances when so prescribed by the appropriate authority or requested by the pilot.

4.10.4.5 A QNH altimeter setting shall be included in the descent clearance when first cleared to an altitude below the transition level, in approach clearances or clearances to enter the traffic circuit, and in taxi clearances for departing aircraft, except when it is known that the aircraft has already received the information.

4.10.4.6 A QFE altimeter setting shall be provided to aircraft on request or on a regular basis in accordance with local arrangements; it shall be the QFE for the aerodrome elevation except for:

- a) non-precision approach runways, if the threshold is 2 m (7 ft) or more below the aerodrome elevation; and
- b) precision approach runways;

in which cases the QFE for the relevant runway threshold shall be provided.

4.10.4.7 Altimeter settings provided to aircraft shall be rounded down to the nearest lower whole hectopascal.

Note 1.— Unless otherwise prescribed by the State concerned, the lowest usable flight level is that flight level which corresponds to, or is immediately above, the established minimum flight altitude.

Note 2.— The portion of a control area for which a particular lowest usable flight level applies is determined in accordance with air traffic services requirements.

Note 3.— See Foreword, Note 2 to paragraph 2.1.

4.11 POSITION REPORTING

4.11.1 Transmission of position reports

4.11.1.1 On routes defined by designated significant points, position reports shall be made by the aircraft when over, or as soon as possible after passing, each designated compulsory reporting point, except as provided in 4.11.1.3 and 4.11.3. Additional reports over other points may be requested by the appropriate ATS unit.

4.11.1.2 On routes not defined by designated significant points, position reports shall be made by the aircraft as soon as possible after the first half hour of flight and at hourly intervals thereafter, except as provided in 4.11.1.3. Additional reports at shorter intervals of time may be requested by the appropriate ATS unit.

4.11.1.3 Under conditions specified by the appropriate ATS authority, flights may be exempted from the requirement to make position reports at each designated compulsory reporting point or interval. In applying this, account should be taken of the meteorological requirement for the making and reporting of routine aircraft observations.

Note.— This is intended to apply in cases where adequate flight progress data are available from other sources, e.g. radar or ADS-B (see Chapter 8, 8.6.4.4), or ADS-C (see Chapter 13) and in other circumstances where the omission of routine reports from selected flights is found to be acceptable.

4.11.1.4 The position reports required by 4.11.1.1 and 4.11.1.2 shall be made to the ATS unit serving the airspace in which the aircraft is operated. In addition, when so prescribed by the appropriate ATS authority in aeronautical information publications or requested by the appropriate ATS unit, the last position report before passing from one FIR or control area to an adjacent FIR or control area shall be made to the ATS unit serving the airspace about to be entered.

4.11.1.5 If a position report is not received at the expected time, subsequent control shall not be based on the assumption that the estimated time is accurate. Immediate action shall be taken to obtain the report if it is likely to have any bearing on the control of other aircraft.

4.11.2 Contents of voice position reports

4.11.2.1 The position reports required by 4.11.1.1 and 4.11.1.2 shall contain the following elements of information, except that elements d), e) and f) may be omitted from position reports transmitted by radiotelephony, when so prescribed on the basis of regional air navigation agreements:

- a) aircraft identification;
- b) position;
- c) time;
- d) flight level or altitude, including passing level and cleared level if not maintaining the cleared level;
- e) next position and time over; and
- f) ensuing significant point.

4.11.2.1.1 Element d), flight level or altitude, shall, however, be included in the initial call after a change of air-ground voice communication channel.

4.11.2.2 When assigned a speed to maintain, the flight crew shall include this speed in their position reports. The assigned speed shall also be included in the initial call after a change of air-ground voice communication channel, whether or not a full position report is required.

Note.— Omission of element d) may be possible when flight level or altitude, as appropriate, derived from pressure-altitude information can be made continuously available to controllers in labels associated with the position indication of aircraft and when adequate procedures have been developed to guarantee the safe and efficient use of this altitude information.

4.11.3 Radiotelephony procedures for air-ground voice communication channel changeover

When so prescribed by the appropriate ATS authority, the initial call to an ATC unit after a change of air-ground voice communication channel shall contain the following elements:

- a) designation of the station being called;
- b) call sign and, for aircraft in the heavy wake turbulence category, the word “Heavy”;
- c) level, including passing and cleared levels if not maintaining the cleared level;
- d) speed, if assigned by ATC; and
- e) additional elements, as required by the appropriate ATS authority.

4.11.4 Transmission of ADS-C reports

The position reports shall be made automatically to the ATS unit serving the airspace in which the aircraft is operating. The requirements for the transmission and contents of automatic dependent surveillance — contract (ADS-C) reports shall be established by the controlling ATC unit on the basis of current operational conditions and communicated to the aircraft and acknowledged through an ADS-C agreement.

4.11.5 Contents of ADS-C reports

4.11.5.1 ADS-C reports shall be composed of data blocks selected from the following:

- a) **Aircraft identification**
- b) **Basic ADS-C**
 - latitude
 - longitude
 - altitude
 - time
 - figure of merit

Note.— The basic ADS-C block is mandatory and is included in all ADS-C reports.

- c) **Ground vector**
 - track
 - ground speed
 - rate of climb or descent
- d) **Air vector**
 - heading
 - Mach or IAS
 - rate of climb or descent

- e) **Projected profile**
 - next waypoint
 - estimated altitude at next waypoint
 - estimated time at next waypoint
 - (next + 1) waypoint
 - estimated altitude at (next + 1) waypoint
 - estimated time at (next + 1) waypoint

- f) **Meteorological information**
 - wind speed
 - wind direction
 - wind quality flag (if available)
 - temperature
 - turbulence (if available)
 - humidity (if available)

Note.— The specifications for the elements in the meteorological information data block, including their ranges and resolutions, are shown in Appendix 3 to Annex 3.

- g) **Short-term intent**
 - latitude at projected intent point
 - longitude at projected intent point
 - altitude at projected intent point
 - time of projection

If an altitude, track or speed change is predicted to occur between the aircraft's current position and the projected intent point, additional information would be provided in an intermediate intent block as follows:

- distance from current point to change point
- track from current point to change point
- altitude at change point
- predicted time to change point

4.11.5.2 The basic ADS-C data block shall be required from all ADS-C-equipped aircraft. Remaining ADS-C data blocks shall be included as necessary. In addition to any requirements concerning its transmission for ATS purposes, data block f) (Meteorological information) shall be transmitted in accordance with Annex 3, 5.3.1. ADS-C emergency and/or urgency reports shall include the emergency and/or urgency status in addition to the relevant ADS-C report information.

4.11.6 Data format of ADS-B messages

Note.— Data formats of ADS-B messages can be found in Annex 10 — Aeronautical Telecommunications, Volume III — Communication Systems, Part I — Digital Data Communication Systems, and Volume IV — Surveillance and Collision Avoidance Systems.

4.12 REPORTING OF OPERATIONAL AND METEOROLOGICAL INFORMATION

4.12.1 General

4.12.1.1 When operational and/or routine meteorological information is to be reported, using data link, by an aircraft en route at times where position reports are required in accordance with 4.11.1.1 and 4.11.1.2, the position report shall be given in accordance with 4.11.5.2 (requirements concerning transmission of meteorological information from ADS-C equipped aircraft), or in the form of a routine air-report. Special aircraft observations shall be reported as special air-reports. All air-reports shall be reported as soon as is practicable.

4.12.2 Contents of routine air-reports

4.12.2.1 Routine air-reports transmitted by data link, when ADS-C is not being applied, shall give information relating to such of the following elements as are necessary for compliance with 4.12.2.2:

Section 1.— Position information:

- 1) aircraft identification
- 2) position
- 3) time
- 4) flight level or altitude
- 5) next position and time over
- 6) ensuing significant point

Section 2.— Operational information:

- 7) estimated time of arrival
- 8) endurance

Section 3.— Meteorological information:

- 9) wind direction
- 10) wind speed
- 11) wind quality flag
- 12) air temperature
- 13) turbulence (if available)
- 14) humidity (if available).

4.12.2.2 Section 1 of the air-report is obligatory, except that elements 5) and 6) thereof may be omitted when so prescribed on the basis of regional air navigation agreements. Section 2 of the air-report, or a portion thereof, shall only be transmitted when so requested by the operator or a designated representative, or when deemed necessary by the pilot-in-command. Section 3 of the air-report shall be transmitted in accordance with Annex 3, Chapter 5.

Note.— While element 4), flight level or altitude, may, in accordance with 4.11.2.1, be omitted from the contents of a position report transmitted by radiotelephony when so prescribed on the basis of regional air navigation agreements, that element may not be omitted from Section 1 of an air-report.

4.12.3 Contents of special air-reports

4.12.3.1 Special air-reports shall be made by all aircraft whenever the following conditions are encountered or observed:

- a) moderate or severe turbulence; or
- b) moderate or severe icing; or
- c) severe mountain wave; or
- d) thunderstorms, without hail that are obscured, embedded, widespread or in squall lines; or
- e) thunderstorms, with hail that are obscured, embedded, widespread or in squall lines; or
- f) heavy duststorm or heavy sandstorm; or
- g) volcanic ash cloud; or
- h) pre-eruption volcanic activity or a volcanic eruption.

Note.— *Pre-eruption volcanic activity in this context means unusual and/or increasing volcanic activity which could presage a volcanic eruption.*

In addition, in the case of transonic and supersonic flight:

- i) moderate turbulence; or
- j) hail; or
- k) cumulonimbus clouds.

4.12.3.2 When air-ground data link is used, special air-reports shall contain the following elements:

message type designator
aircraft identification

Data block 1:

latitude
longitude
pressure-altitude
time

Data block 2:

wind direction
wind speed
wind quality flag
air temperature
turbulence (if available)
humidity (if available)

Data block 3:

condition prompting the issuance of the special air-report; to be selected from the list a) to k) presented under 4.12.3.1.

4.12.3.3 When voice communications are used, special air-reports shall contain the following elements:

Message type designator

Section 1.— Position information

- 1) aircraft identification
- 2) position
- 3) time
- 4) flight level or altitude

Section 3.— Meteorological information

- 5) condition prompting the issuance of the special air-report; to be selected from the list a) to k) presented under 4.12.3.1.

4.12.4 Compilation and transmission of air-reports by voice communications

4.12.4.1 Forms based on the model AIREP SPECIAL form at Appendix 1 shall be provided for the use of flight crews in compiling the reports. The detailed instructions for reporting, as given at Appendix 1, shall be complied with.

4.12.4.2 The detailed instructions, including the formats of messages and the phraseologies given at Appendix 1, shall be used by flight crews when transmitting air-reports and by air traffic services units when retransmitting such reports.

Note.— Increasing use of air-reports in automated systems makes it essential that the elements of such reports be transmitted in the order and form prescribed.

4.12.5 Recording of special air-reports of volcanic activity

Special air-reports containing observations of volcanic activity shall be recorded on the special air-report of volcanic activity form. Forms based on the model form for special air-reports of volcanic activity at Appendix 1 shall be provided for flight crews operating on routes which could be affected by volcanic ash clouds.

Note.— The recording and reporting instructions may conveniently be printed on the back of the special air-report of volcanic activity form.

4.12.6 Forwarding of meteorological information

4.12.6.1 When receiving ADS-C reports which contain a meteorological information block, air traffic services units shall relay the basic ADS-C and meteorological information blocks and aircraft registration without delay to the world area forecast centres (WAFCs).

Note.— Specifications concerning the format to be used in the relay of meteorological information to the WAFCs are contained in the Manual on Aeronautical Meteorological Practice (Doc 8896).

4.12.6.2 When receiving special air-reports by data link communications, air traffic services units shall forward them without delay to their associated meteorological watch office, the WAFCs, and the centres designated by regional air navigation agreement for the operation of aeronautical fixed service Internet-based services.

4.12.6.3 When receiving special air-reports by voice communications, air traffic services units shall forward them without delay to their associated meteorological watch offices.

4.13 PRESENTATION AND UPDATING OF FLIGHT PLAN AND CONTROL DATA

4.13.1 General

The appropriate authority shall establish provisions and procedures for the presentation to controllers, and subsequent updating, of flight plan and control data for all flights being provided with a service by an ATS unit. Provision shall also be made for the presentation of any other information required or desirable for the provision of ATS.

4.13.2 Information and data to be presented

4.13.2.1 Sufficient information and data shall be presented in such a manner as to enable the controller to have a complete representation of the current air traffic situation within the controller's area of responsibility and, when relevant, movements on the manoeuvring area of aerodromes. The presentation shall be updated in accordance with the progress of aircraft, in order to facilitate the timely detection and resolution of conflicts as well as to facilitate and provide a record of coordination with adjacent ATS units and control sectors.

4.13.2.2 An appropriate representation of the airspace configuration, including significant points and information related to such points, shall be provided. Data to be presented shall include relevant information from flight plans and position reports as well as clearance and coordination data. The information display may be generated and updated automatically, or the data may be entered and updated by authorized personnel.

4.13.2.3 Requirements regarding other information to be displayed, or to be available for display, shall be specified by the appropriate authority.

4.13.3 Presentation of information and data

4.13.3.1 The required flight plan and control data may be presented through the use of paper flight progress strips or electronic flight progress strips, by other electronic presentation forms or by a combination of presentation methods.

4.13.3.2 The method(s) of presenting information and data shall be in accordance with Human Factors principles. All data, including data related to individual aircraft, shall be presented in a manner minimizing the potential for misinterpretation or misunderstanding.

4.13.3.3 Means and methods for manually entering data in ATC automation systems shall be in accordance with Human Factors principles.

4.13.3.4 When flight progress strips (FPS) are used, there should be at least one individual FPS for each flight. The number of FPS for individual flights shall be sufficient to meet the requirements of the ATS unit concerned. Procedures for annotating data and provisions specifying the types of data to be entered on FPS, including the use of symbols, shall be specified by the appropriate ATS authority.

Note.— Guidance material on the use of paper FPS is contained in the Air Traffic Services Planning Manual (Doc 9426).

4.13.3.5 Data generated automatically shall be presented to the controller in a timely manner. The presentation of information and data for individual flights shall continue until such time as the data is no longer required for the purpose of providing control, including conflict detection and the coordination of flights, or until terminated by the controller.

4.13.4 Recording and retention of data for investigative purposes

Paper FPS shall be retained for a period of at least 30 days. Electronic flight progress and coordination data shall be recorded and retained for at least the same period of time.

4.14 FAILURE OR IRREGULARITY OF SYSTEMS AND EQUIPMENT

ATC units shall immediately report in accordance with local instructions any failure or irregularity of communication, navigation and surveillance systems or any other safety-significant systems or equipment which could adversely affect the safety or efficiency of flight operations and/or the provision of air traffic control service.

4.15 DATA LINK COMMUNICATIONS INITIATION PROCEDURES

4.15.1 General

Note 1.— Provisions concerning the data link initiation capability (DLIC) are contained in Annex 10, Volume II, Chapter 8.

Note 2.— Guidance material relating to the implementation of DLIC can be found in the Global Operational Data Link (GOLD) Manual (Doc 10037).

4.15.1.1 Before entering an airspace where data link applications are used by the ATS unit, data link communications shall be initiated between the aircraft and the ATS unit in order to register the aircraft and, when necessary, allow the start of a data link application. This shall be initiated by the aircraft, either automatically or by the pilot, or by the ATS unit on address forwarding.

4.15.1.2 The logon address associated with an ATS unit shall be published in Aeronautical Information Publications in accordance with Annex 15.

Note.— A given FIR may have multiple logon addresses; and more than one FIR may share the same logon address.

4.15.2 Aircraft initiation

On receipt of a valid data link initiation request from an aircraft approaching or within a data link service area, the ATS unit shall accept the request and, if able to correlate it with a flight plan, shall establish a connection with the aircraft.

4.15.3 ATS unit forwarding

Where the ground system initially contacted by the aircraft is able to pass the necessary aircraft address information to another ATS unit, it shall pass the aircraft updated ground addressing information for data link applications previously coordinated in sufficient time to permit the establishment of data link communications.

4.15.4 Failure

4.15.4.1 In the case of a data link initiation failure, the data link system shall provide an indication of the failure to the appropriate ATS unit(s). The data link system shall also provide an indication of the failure to the flight crew when a data link initiation failure results from a logon initiated by the flight crew.

Note.— When the aircraft's logon request results from responding to a contact request by a transferring ATS unit, then both ATS units will receive the indication.

4.15.4.2 The ATS unit shall establish procedures to resolve, as soon as practicable, data link initiation failures. Procedures should include, as a minimum, verifying that the aircraft is initiating a data link request with the appropriate ATS unit (i.e. the aircraft is approaching or within the ATS unit's control area), and if so:

- a) when a flight plan is available, verify that the aircraft identification, aircraft registration, or aircraft address and other details contained in the data link initiation request correspond with details in the flight plan, and where differences are detected, verify which is the correct information and make the necessary changes; or
- b) when a flight plan is not available, create a flight plan with sufficient information in the flight data processing system to achieve a successful data link initiation; then
- c) arrange for the re-initiation of the data link.

4.15.4.3 The aircraft operator shall establish procedures to resolve, as soon as practicable, data link initiation failures. Procedures should include, as a minimum, that the pilot:

- a) verify the correctness and consistency of the flight plan information available in the FMS or equipment from which the data link is initiated, and where differences are detected, make the necessary changes;
- b) verify the correct address of the ATS unit; then
- c) re-initiate the data link.

Chapter 5

SEPARATION METHODS AND MINIMA

5.1 INTRODUCTION

Note 1.— With the exceptions stated below, Chapter 5 contains procedures and procedural separation minima for use in the separation of aircraft in the en-route phase as well as aircraft in the arrival and departure phases of flight.

Note 2.— Procedures and separation minima applicable to approaches to parallel runways are contained in Chapter 6. Procedures and separation minima applicable in the provision of aerodrome control service are contained in Chapter 7 and procedures and separation minima applicable to the use of ATS surveillance systems are contained in Chapter 8.

Note 3.— Attention is drawn to the use of strategic lateral offset procedures (SLOP) described in Chapter 16, 16.5.

Note 4.— Procedures applicable to data link initiation capability (DLIC) are contained in Chapter 4. Procedures applicable to automatic dependent surveillance — contract (ADS-C) are contained in Chapter 13. Procedures applicable to controller-pilot data link communications (CPDLC) are contained in Chapter 14.

5.2 PROVISIONS FOR THE SEPARATION OF CONTROLLED TRAFFIC

5.2.1 General

5.2.1.1 Vertical or horizontal separation shall be provided:

- a) between all flights in Class A and B airspaces;
- b) between IFR flights in Class C, D and E airspaces;
- c) between IFR flights and VFR flights in Class C airspace;
- d) between IFR flights and special VFR flights; and
- e) between special VFR flights, when so prescribed by the appropriate ATS authority;

except, for the cases under b) above in airspace Classes D and E, during the hours of daylight when flights have been cleared to climb or descend subject to maintaining own separation and remaining in visual meteorological conditions. Conditions applicable to the use of this procedure are contained in Section 5.9.

5.2.1.2 No clearance shall be given to execute any manoeuvre that would reduce the spacing between two aircraft to less than the separation minimum applicable in the circumstances.

5.2.1.3 Larger separations than the specified minima should be applied whenever exceptional circumstances such as unlawful interference or navigational difficulties call for extra precautions. This should be done with due regard to all relevant factors so as to avoid impeding the flow of air traffic by the application of excessive separations.

Note.— *Unlawful interference with an aircraft constitutes a case of exceptional circumstances which might require the application of separations larger than the specified minima, between the aircraft being subjected to unlawful interference and other aircraft.*

5.2.1.4 Where the type of separation or minimum used to separate two aircraft cannot be maintained, another type of separation or another minimum shall be established prior to the time when the current separation minimum would be infringed.

5.2.2 Degraded aircraft performance

Whenever, as a result of failure or degradation of navigation, communications, altimetry, flight control or other systems, aircraft performance is degraded below the level required for the airspace in which it is operating, the flight crew shall advise the ATC unit concerned without delay. Where the failure or degradation affects the separation minimum currently being employed, the controller shall take action to establish another appropriate type of separation or separation minimum.

5.3 VERTICAL SEPARATION

5.3.1 Vertical separation application

Vertical separation is obtained by requiring aircraft using prescribed altimeter setting procedures to operate at different levels expressed in terms of flight levels or altitudes in accordance with the provisions in Chapter 4, Section 4.10.

5.3.2 Vertical separation minimum

The vertical separation minimum (VSM) shall be:

- a) a nominal 300 m (1 000 ft) below FL 290 and a nominal 600 m (2 000 ft) at or above this level, except as provided for in b) below; and
- b) within designated airspace, subject to a regional air navigation agreement: a nominal 300 m (1 000 ft) below FL 410 or a higher level where so prescribed for use under specified conditions, and a nominal 600 m (2 000 ft) at or above this level.

Note.— *Guidance material relating to vertical separation is contained in the Manual on a 300 m (1 000 ft) Vertical Separation Minimum Between FL 290 and FL 410 Inclusive (Doc 9574).*

5.3.3 Assignment of cruising levels for controlled flights

5.3.3.1 Except when traffic conditions and coordination procedures permit authorization of cruise climb, an ATC unit shall normally authorize only one level for an aircraft beyond its control area, i.e. that level at which the aircraft will enter the next control area whether contiguous or not. It is the responsibility of the accepting ATC unit to issue clearance for further climb as appropriate. When relevant, aircraft will be advised to request en route any cruising level changes desired.

5.3.3.2 Aircraft authorized to employ cruise climb techniques shall be cleared to operate between two levels or above a level.

5.3.3.3 If it is necessary to change the cruising level of an aircraft operating along an established ATS route extending partly within and partly outside controlled airspace and where the respective series of cruising levels are not identical, the change shall, whenever possible, be effected within controlled airspace.

5.3.3.4 When an aircraft has been cleared into a control area at a cruising level which is below the established minimum cruising level for a subsequent portion of the route, the ATC unit responsible for the area should issue a revised clearance to the aircraft even though the pilot has not requested the necessary cruising level change.

5.3.3.5 An aircraft may be cleared to change cruising level at a specified time, place or rate.

Note.— See 5.3.4.1.1 concerning procedures for vertical speed control.

5.3.3.6 In so far as practicable, cruising levels of aircraft flying to the same destination shall be assigned in a manner that will be correct for an approach sequence at destination.

5.3.3.7 An aircraft at a cruising level shall normally have priority over other aircraft requesting that cruising level. When two or more aircraft are at the same cruising level, the preceding aircraft shall normally have priority.

5.3.3.8 The cruising levels, or, in the case of cruise climb, the range of levels, to be assigned to controlled flights shall be selected from those allocated to IFR flights in:

- a) the tables of cruising levels in Appendix 3 of Annex 2; or
- b) a modified table of cruising levels, when so prescribed in accordance with Appendix 3 of Annex 2 for flights above FL 410;

except that the correlation of levels to track as prescribed therein shall not apply whenever otherwise indicated in air traffic control clearances or specified by the appropriate ATS authority in AIPs.

5.3.4 Vertical separation during climb or descent

5.3.4.1 An aircraft may be cleared to a level previously occupied by another aircraft after the latter has reported vacating it, except when:

- a) severe turbulence is known to exist;
- b) the higher aircraft is effecting a cruise climb; or
- c) the difference in aircraft performance is such that less than the applicable separation minimum may result;

in which case such clearance shall be withheld until the aircraft vacating the level has reported at or passing another level separated by the required minimum.

5.3.4.1.1 When the aircraft concerned are entering or established in the same holding pattern, consideration shall be given to aircraft descending at markedly different rates and, if necessary, additional measures such as specifying a maximum descent rate for the higher aircraft and a minimum descent rate for the lower aircraft should be applied to ensure that the required separation is maintained.

5.3.4.2 Pilots in direct communication with each other may, with their concurrence, be cleared to maintain a specified vertical separation between their aircraft during ascent or descent.

5.4 HORIZONTAL SEPARATION

Note 1.— Nothing in the provisions detailed in Sections 5.4.1 and 5.4.2 hereunder precludes a State from establishing:

- a) other minima for use in circumstances not prescribed; or*
- b) additional conditions to those prescribed for the use of a given minimum;*

provided that the level of safety inherent in the provisions detailed in Sections 5.4.1 and 5.4.2 hereunder is at all times assured.

Note 2.— Details on track spacing between parallel routes are provided in Annex 11, Attachments A and B.

Note 3.— Attention is drawn to the following guidance material:

- a) Air Traffic Services Planning Manual (Doc 9426);*
- b) Manual on Airspace Planning Methodology for the Determination of Separation Minima (Doc 9689); and*
- c) Performance-based Navigation (PBN) Manual (Doc 9613).*

Note 4.— Provisions concerning reductions in separation minima are contained in Section 5.11 and in Chapter 2, ATS Safety Management.

5.4.1 Lateral separation

5.4.1.1 LATERAL SEPARATION APPLICATION

5.4.1.1.1 Lateral separation shall be applied so that the distance between those portions of the intended routes for which the aircraft are to be laterally separated is never less than an established distance to account for navigational inaccuracies plus a specified buffer. This buffer shall be determined by the appropriate authority and included in the lateral separation minima as an integral part thereof.

Note.— In the minima specified in 5.4.1.2 an appropriate buffer has already been included.

5.4.1.1.2 Lateral separation of aircraft is obtained by requiring operation on different routes or in different geographical locations as determined by visual observation, by the use of navigation aids or by the use of area navigation (RNAV) equipment.

5.4.1.1.3 When information is received indicating navigation equipment failure or deterioration below the navigation performance requirements, ATC shall then, as required, apply alternative separation methods or minima.

5.4.1.1.4 When an aircraft turns onto an ATS route via a flyover waypoint, a separation other than the normally prescribed lateral separation shall be applied for that portion of the flight between the flyover waypoint where the turn is executed and the next waypoint (see Figures 5-1 and 5-2).

Note 1.— For flyover waypoints aircraft are required to first fly over the waypoint before executing the turn. After the turn the aircraft may either navigate to join the route immediately after the turn or navigate to the next defined waypoint before re-joining the route. This will require additional lateral separation on the overflown side of the turn.

Note 2.— This does not apply to ATS routes that have turns using fly-by waypoints.

Note 3.— An example of a prescribed lateral separation minima based on a specific navigation performance can be found in 5.4.1.2.1.6.

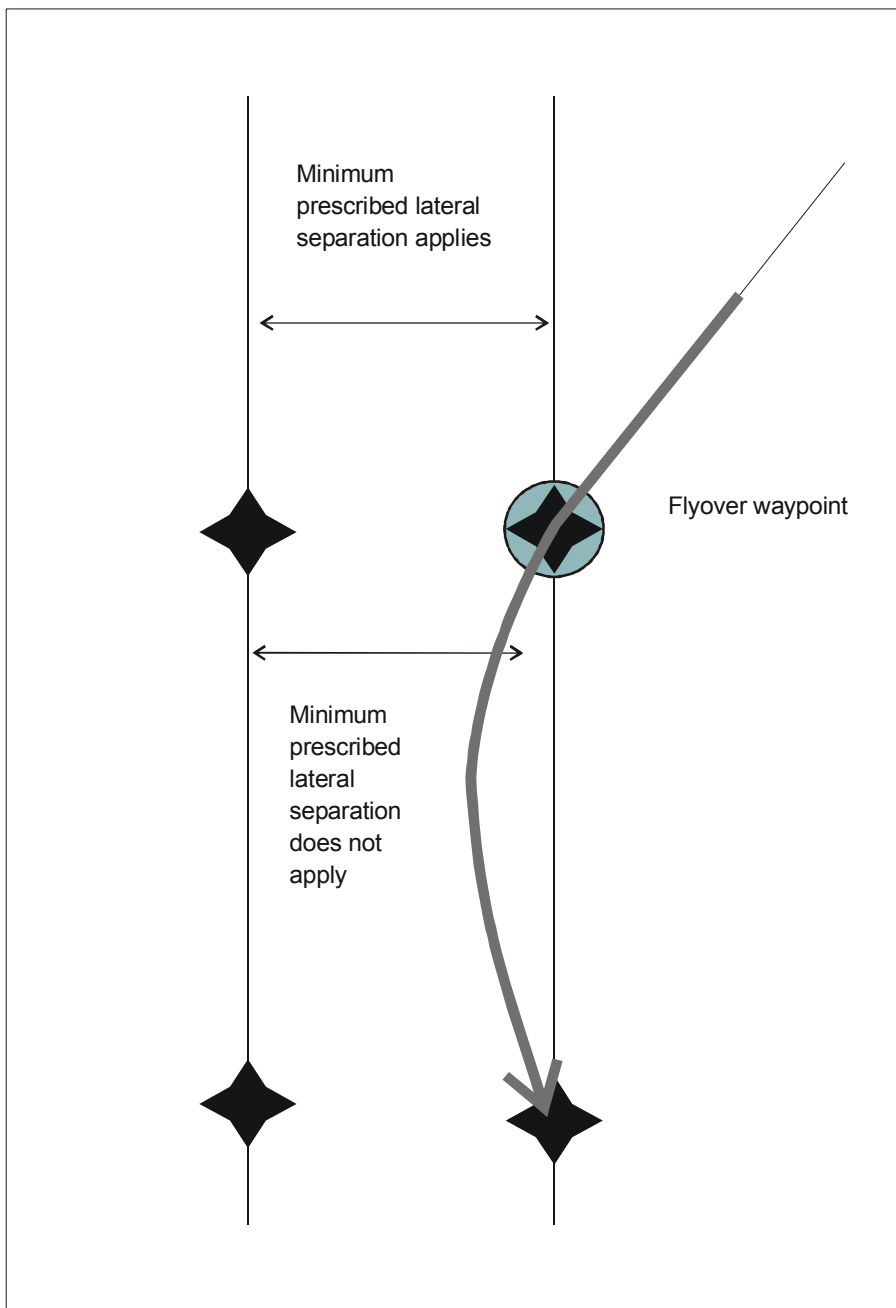

Figure 5-1. Turn over flyover waypoint (See 5.4.1.1.4)

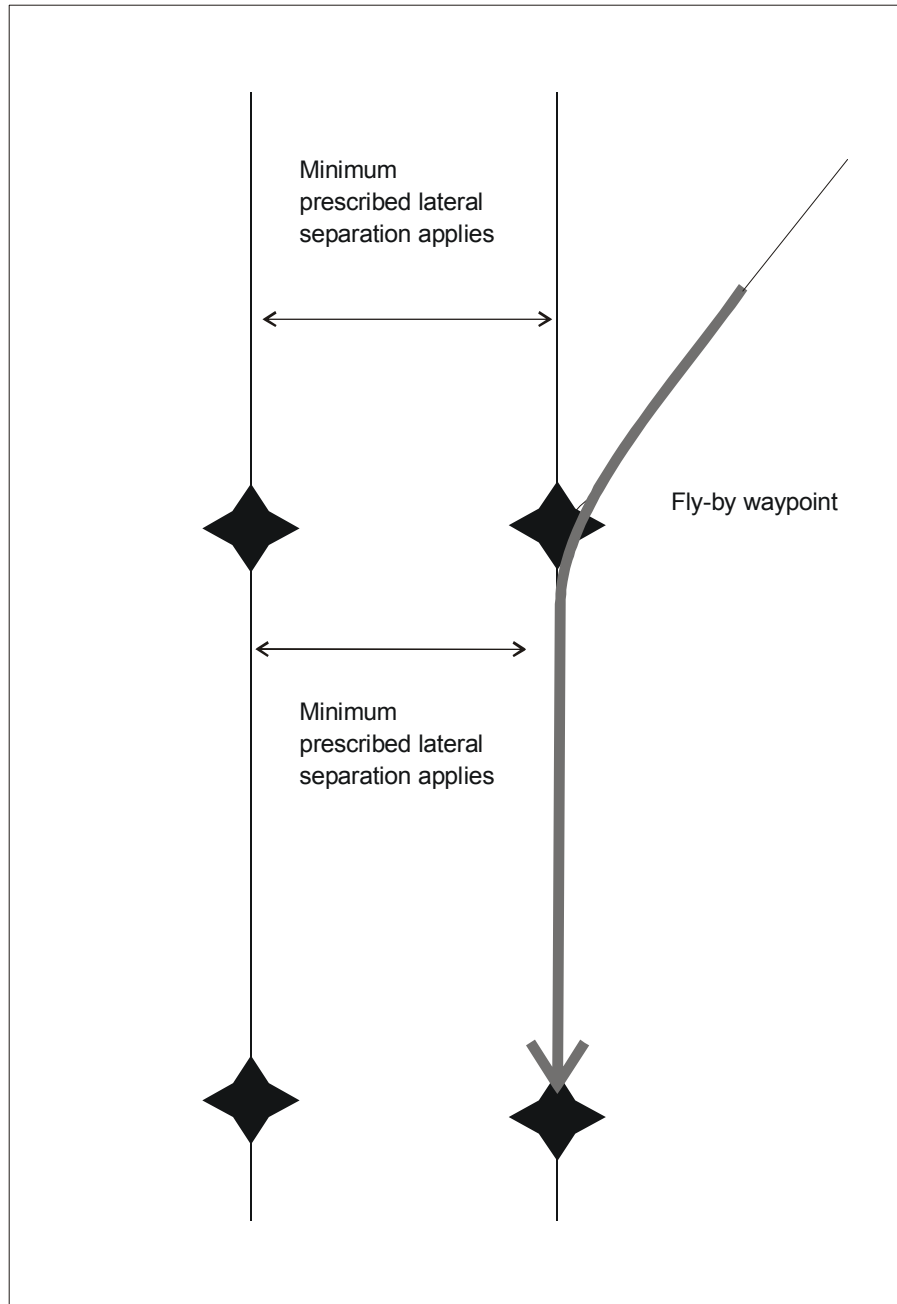

Figure 5-2. Turn at fly-by waypoint (See 5.4.1.1.4)

5.4.1.2 LATERAL SEPARATION CRITERIA AND MINIMA

5.4.1.2.1 Means by which lateral separation may be applied include the following:

5.4.1.2.1.1 *By reference to the same or different geographic locations.* By position reports which positively indicate the aircraft are over different geographic locations as determined visually or by reference to a navigation aid (see Figure 5-3).

5.4.1.2.1.2 *By use of NDB, VOR or GNSS on intersecting tracks or ATS routes.* By requiring aircraft to fly on specified tracks which are separated by a minimum amount appropriate to the navigation aid employed. Lateral separation between two aircraft exists when:

- a) *VOR:* both aircraft are established on radials diverging by at least 15 degrees and at least one aircraft is at a distance of 28 km (15 NM) or more from the facility (see Figure 5-4);
- b) *NDB:* both aircraft are established on tracks to or from the NDB which are diverging by at least 30 degrees and at least one aircraft is at a distance of 28 km (15 NM) or more from the facility (see Figure 5-5);
- c) *GNSS/GNSS:* each aircraft is confirmed to be established on a track with zero offset between two waypoints and at least one aircraft is at a minimum distance from a common point as specified in Table 5-1; or
- d) *VOR/GNSS:* the aircraft using VOR is established on a radial to or from the VOR and the other aircraft using GNSS is confirmed to be established on a track with zero offset between two waypoints and at least one aircraft is at a minimum distance from a common point as specified in Table 5-1.

Table 5-1. Lateral separation for aircraft flying VOR and GNSS

Angular difference between tracks measured at the common point (degrees)	Aircraft 1: VOR or GNSS Aircraft 2: GNSS	
	FL010 – FL190 Distance from a common point	FL200 – FL600 Distance from a common point
15 – 135	27.8 km (15 NM)	43 km (23 NM)
The distances in the table are ground distances. States must take into account the distance (slant range) from the source of a DME signal to the receiving antenna when DME is being utilized to provide range information.		

Note 1.— The values in Table 5-1 are from a larger table of values derived by collision risk analysis. The source table for separation of aircraft navigating by means of GNSS and VOR is contained in Circular 322, Guidelines for the Implementation of GNSS Lateral Separation Minima based on VOR Separation Minima. States may refer to Circular 322 for greater detail and other angular differences and separation distances.

Note 2.— The values in Table 5-1 have accounted for distances from the common point encompassed by the theoretical turn area for fly-by turns as specified in the Minimum Aviation System Performance Standard: Required Navigation Performance for Air Navigation (ED-75B/DO-236B), section 3.2.5.4, and fixed radius transition turns as defined in the Performance-based Navigation (PBN) Manual (Doc 9613).

Note 3.— Guidance material for the implementation of GNSS lateral separation is contained in Circular 322, Guidelines for the Implementation of GNSS Lateral Separation Minima Based on VOR Separation Minima.

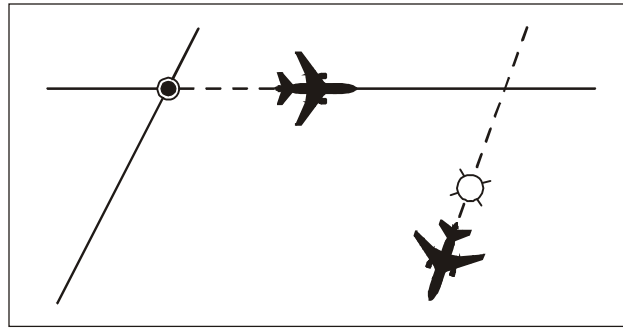

Figure 5-3. Using same or different geographic locations (see 5.4.1.2.1.1)

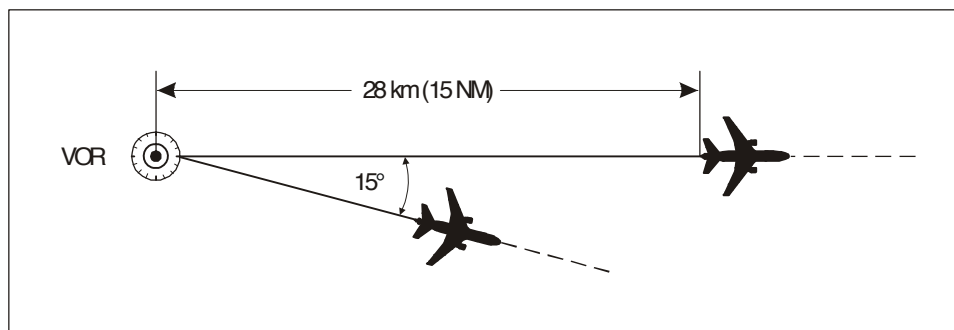

Figure 5-4. Separation using the same VOR (see 5.4.1.2.1.2 a))

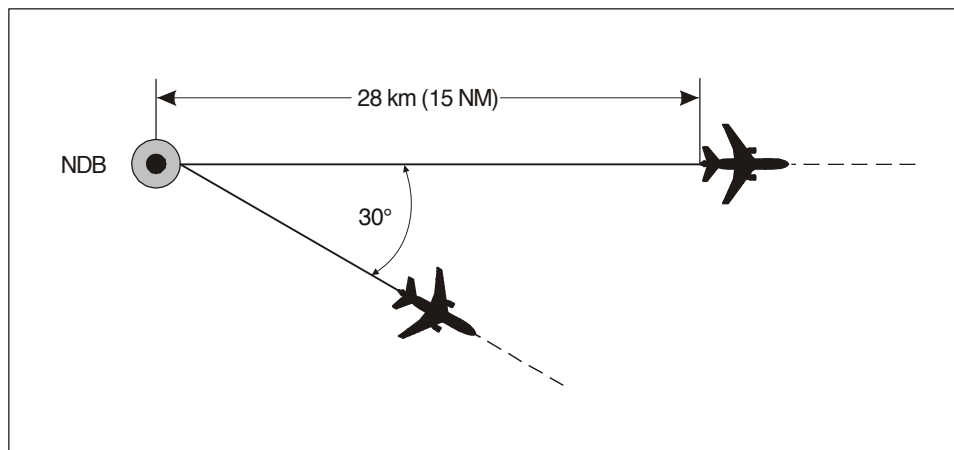

Figure 5-5. Separation using the same NDB (see 5.4.1.2.1.2 b))

5.4.1.2.1.2.1 When aircraft are operating on tracks which are separated by considerably more than the minimum in 5.4.1.2.1.2 a) and b), States may reduce the distance at which lateral separation is achieved.

5.4.1.2.1.2.2 Before applying GNSS-based track separation, the controller shall confirm the following:

- a) ensure that the aircraft is navigating using GNSS; and

- b) in airspace where strategic lateral offsets are authorized, that a lateral offset is not being applied.

5.4.1.2.1.2.3 In order to minimize the possibility of operational errors, waypoints contained in the navigation database or uplinked to the aircraft flight management system should be used in lieu of manually entered waypoints, when applying GNSS-based track separation. In the event that it is operationally restrictive to use waypoints contained in the navigation database, the use of waypoints that require manual entry by pilots should be limited to a half or whole degree of latitude and longitude.

5.4.1.2.1.2.4 GNSS-based track separation shall not be applied in cases of pilot-reported receiver autonomous integrity monitoring (RAIM) outages.

Note.— For the purpose of applying GNSS-based lateral separation minima, distance and track information derived from an integrated navigation system incorporating GNSS input is regarded as equivalent to GNSS distance and track.

5.4.1.2.1.2.5 GNSS receivers used for applying separation shall meet the requirements in Annex 10, Volume I, and be indicated in the flight plan.

5.4.1.2.1.3 *By use of different navigation aids or methods.* Lateral separation between aircraft using different navigation aids, or when one aircraft is using RNAV equipment, shall be established by ensuring that the derived protected airspaces for the navigation aid(s) or RNP do not overlap.

5.4.1.2.1.4 *Lateral separation of aircraft on published instrument flight procedures for arrivals and departures.*

5.4.1.2.1.4.1 Lateral separation of departing and/or arriving aircraft, using instrument flight procedures, will exist:

- a) where the distance between any combination of RNAV 1 with RNAV 1, or RNP 1, RNP APCH or RNP AR APCH tracks is not less than 13 km (7 NM); or
- b) where the distance between any combination of RNP 1, RNP APCH or RNP AR APCH tracks is not less than 9.3 km (5 NM); or
- c) where the protected areas of tracks designed using obstacle clearance criteria do not overlap and provided operational error is considered.

Note 1.— Distance values contained in a) and b) above were determined by collision risk analysis using multiple navigation specifications. Information on this analysis is contained in Circular 324, Guidelines for Lateral Separation of Arriving and Departing Aircraft on Published Adjacent Instrument Flight Procedures.

Note 2.— Circular 324 also contains information on separation of arrival and departure tracks using non-overlapping protected areas based on obstacle clearance criteria, as provided for in the Procedures for Air Navigation Services — Aircraft Operations, Volume II — Construction of Visual and Instrument Flight Procedures (PANS-OPS, Doc 8168).

Note 3.— Provisions concerning reductions in separation minima are contained in Chapter 2, ATS Safety Management, and Chapter 5, Separation Methods and Minima, Section 5.11.

Note 4.— Guidance concerning the navigation specifications is contained in the Performance-based Navigation (PBN) Manual (Doc 9613).

5.4.1.2.1.5 *RNAV operations where RNP is specified on parallel tracks or ATS routes.* Within designated airspace or on designated routes, where RNP is specified, lateral separation between RNAV-equipped aircraft may be obtained by requiring aircraft to be established on the centre lines of parallel tracks or ATS routes spaced at a distance which ensures that the protected airspace of the tracks or ATS routes does not overlap.

Note.— The spacing between parallel tracks or between parallel ATS route centre lines for which an RNP type is required will be dependent upon the relevant RNP type specified. Guidance material related to the spacing between tracks or ATS routes based on RNP type is contained in Annex 11, Attachment B.

5.4.1.2.1.6 *Lateral separation of aircraft on parallel or non-intersecting tracks or ATS routes.* Within designated airspace or on designated routes, lateral separation between aircraft operating on parallel or non-intersecting tracks or ATS routes shall be established in accordance with the following:

- a) for a minimum spacing between tracks of 93 km (50 NM) a navigational performance of RNAV 10 (RNP 10), RNP 4 or RNP 2 shall be prescribed;
- b) for a minimum spacing between tracks of 42.6 km (23 NM) a navigational performance of RNP 4 or RNP 2 shall be prescribed. The communication system shall satisfy required communication performance 240 (RCP 240) and the surveillance system shall satisfy required surveillance performance 180 (RSP 180). Conformance monitoring shall be ensured by establishing an ADS-C event contract specifying a lateral deviation change event with a maximum of 5 NM threshold and a waypoint change event;
- c) for a minimum spacing between tracks of 27.8 km (15 NM) a navigational performance of RNP 2 or a GNSS equipage shall be prescribed. Direct controller-pilot VHF voice communication shall be maintained while such separation is applied;
- d) for a minimum spacing between tracks of 13 km (7 NM), applied while one aircraft climbs/descends through the level of another aircraft, a navigational performance of RNP 2 or a GNSS equipage shall be prescribed. Direct controller-pilot VHF voice communication shall be maintained while such separation is applied; and
- e) for a minimum spacing between tracks of 37 km (20 NM), applied while one aircraft climbs/descends through the level of another aircraft whilst using other types of communication than specified in d) above, a navigational performance of RNP 2 or a GNSS equipage shall be prescribed.

Note 1.— Guidance material for the implementation of the navigation capability supporting 93 km (50 NM), 42.6 km (23 NM), 37 km (20 NM), 27.8 km (15 NM) and 13 km (7 NM) lateral separation minima is contained in the Performance-based Navigation (PBN) Manual (Doc 9613). Guidance material for the implementation of the 93 km (50 NM), 42.6 km (23 NM), 37 km (20 NM), 27.8 km (15 NM) and 13 km (7 NM) lateral separation minima is contained in Circular 341, Guidelines for the Implementation of Lateral Separation Minima.

Note 2.— Guidance material for implementation of communication and surveillance capability supporting 93 km (50 NM) and 42.6 km (23 NM) lateral separation minima is contained in the Performance-based Communication and Surveillance (PBCS) Manual (Doc 9869) and the Global Operational Data Link (GOLD) Manual (Doc 10037).

Note 3.— See Appendix 2, ITEM 10: EQUIPMENT AND CAPABILITIES, in relation to the GNSS prescribed in c), d) and e) above.

5.4.1.2.1.7 *Lateral separation of aircraft on intersecting tracks or ATS routes.* Lateral separation between aircraft operating on intersecting tracks or ATS routes shall be established in accordance with the following.

- a) an aircraft converging with the track of another aircraft is laterally separated until it reaches a lateral separation point that is located a specified distance measured perpendicularly from the track of the other aircraft (see Figure 5-6); and
- b) an aircraft diverging from the track of another aircraft is laterally separated after passing a lateral separation point that is located a specified distance measured perpendicularly from the track of the other aircraft (see Figure 5-6).

This type of separation may be used for tracks that intersect at any angles using the values for lateral separation points specified below:

<i>Navigation</i>	<i>Separation</i>
RNAV 10 (RNP 10)	93 km (50 NM)
RNP 4	42.6 km (23 NM)
RNP 2	27.8 km (15 NM)

5.4.1.2.1.8 When applying the 27.8 km (15 NM) separation minima specified in the table above, a GNSS, as indicated in the flight plan by the letter G meets the specified navigation performance.

Note.— Guidance material for the implementation of the navigation capability supporting 93 km (50 NM), 42.6 km (23 NM), and 27.8 km (15 NM) lateral separation minima is contained in the Performance-based Navigation (PBN) Manual (Doc 9613). Supporting information for the implementation of the 93 km (50 NM), 42.6 km (23 NM) and 27.8 km (15 NM) lateral separation minima is contained in Circular 341, Guidelines for the Implementation of Lateral Separation Minima.

5.4.1.2.1.9 *Transitioning into airspace where a greater lateral separation minimum applies.* Lateral separation will exist when aircraft are established on specified tracks which:

- a) are separated by an appropriate minimum; and
- b) diverge by at least 15 degrees until the applicable lateral separation minimum is established;

providing that it is possible to ensure, by means approved by the appropriate ATS authority, that aircraft have the navigation capability necessary to ensure accurate track guidance.

5.4.2 Longitudinal separation

5.4.2.1 LONGITUDINAL SEPARATION APPLICATION

5.4.2.1.1 Longitudinal separation shall be applied so that the spacing between the estimated positions of the aircraft being separated is never less than a prescribed minimum. Longitudinal separation between aircraft following the same or diverging tracks may be maintained by application of speed control, including the Mach number technique. When applicable, use of the Mach number technique shall be prescribed on the basis of a regional air navigation agreement.

Note 1.— Attention is drawn to the guidance material contained in the Air Traffic Services Planning Manual (Doc 9426) regarding the application of the Mach number technique to separation of subsonic aircraft.

Note 2.— The Mach number technique is applied using true Mach number.

5.4.2.1.2 In applying a time- or distance-based longitudinal separation minimum between aircraft following the same track, care shall be exercised to ensure that the separation minimum will not be infringed whenever the following aircraft is maintaining a higher airspeed than the preceding aircraft. When aircraft are expected to reach minimum separation, speed control shall be applied to ensure that the required separation minimum is maintained.

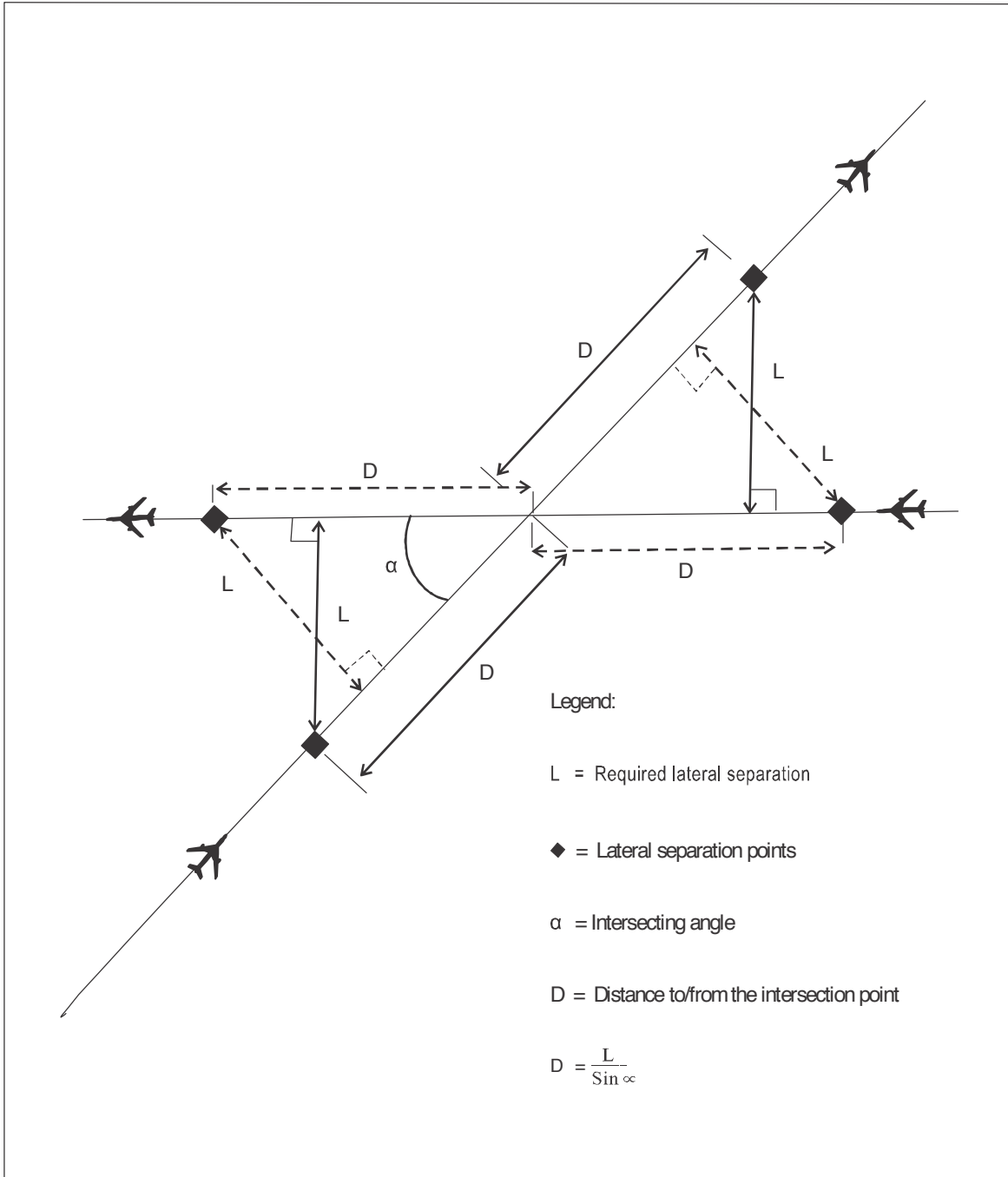

Figure 5-6. Lateral separation points (see 5.4.1.2.1.7)

5.4.2.1.3 Longitudinal separation may be established by requiring aircraft to depart at a specified time, to arrive over a geographical location at a specified time, or to hold over a geographical location until a specified time.

5.4.2.1.4 Longitudinal separation between supersonic aircraft during the transonic acceleration and supersonic phases of flight should normally be established by appropriate timing of the start of transonic acceleration rather than by the imposition of speed restrictions in supersonic flight.

5.4.2.1.5 For the purpose of application of longitudinal separation, the terms *same track*, *reciprocal tracks* and *crossing tracks* shall have the following meanings:

- a) Same track (see Figure 5-7):

same direction tracks and intersecting tracks or portions thereof, the angular difference of which is less than 45 degrees or more than 315 degrees, and whose protected airspaces overlap.

- b) Reciprocal tracks (see Figure 5-8):

opposite tracks and intersecting tracks or portions thereof, the angular difference of which is more than 135 degrees but less than 225 degrees, and whose protected airspaces overlap.

- c) Crossing tracks (see Figure 5-9):

intersecting tracks or portions thereof other than those specified in a) and b) above.

5.4.2.1.6 Time-based separation applied in accordance with 5.4.2.2 and 5.4.2.4 may be based on position information and estimates derived from voice reports, CPDLC or ADS-C.

5.4.2.2 LONGITUDINAL SEPARATION MINIMA BASED ON TIME

5.4.2.2.1 AIRCRAFT MAINTAINING THE SAME LEVEL

5.4.2.2.1.1 Aircraft flying on the same track:

- a) 15 minutes (see Figure 5-10); or
- b) 10 minutes, if navigation aids permit frequent determination of position and speed (see Figure 5-11); or
- c) 5 minutes in the following cases, provided that in each case the preceding aircraft is maintaining a true airspeed of 37 km/h (20 kt) or more faster than the succeeding aircraft (see Figure 5-12):
- 1) between aircraft that have departed from the same aerodrome;
 - 2) between en-route aircraft that have reported over the same exact significant point;
 - 3) between departing and en-route aircraft after the en-route aircraft has reported over a fix that is so located in relation to the departure point as to ensure that five-minute separation can be established at the point the departing aircraft will join the air route; or
- d) 3 minutes in the cases listed under c) provided that in each case the preceding aircraft is maintaining a true airspeed of 74 km/h (40 kt) or more faster than the succeeding aircraft (see Figure 5-13).

5.4.2.2.1.2 Aircraft flying on crossing tracks:

- a) 15 minutes at the point of intersection of the tracks (see Figure 5-14); or
- b) 10 minutes if navigation aids permit frequent determination of position and speed (see Figure 5-15).

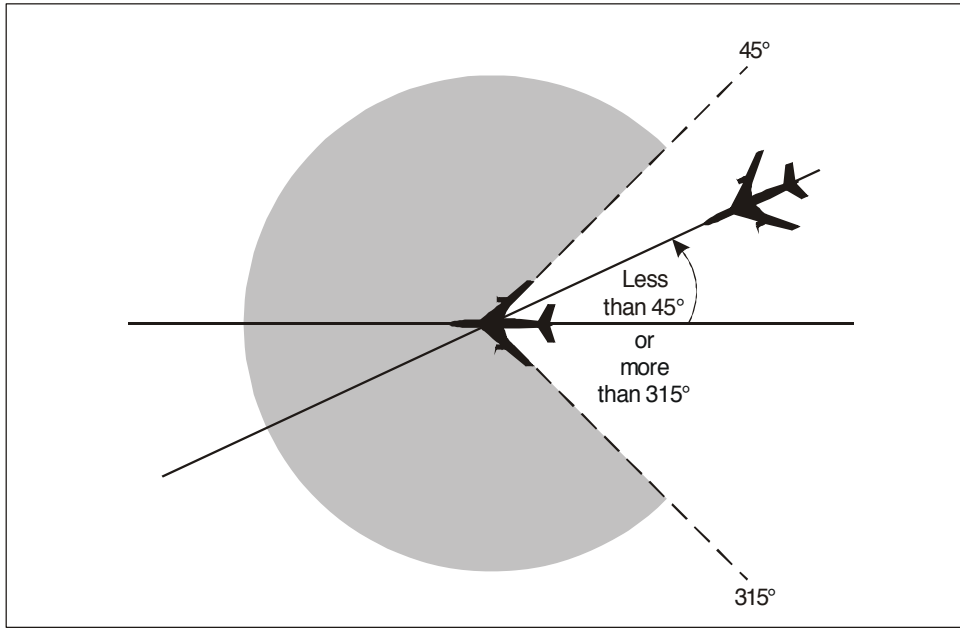

Figure 5-7. Aircraft on same track (see 5.4.2.1.5 a))

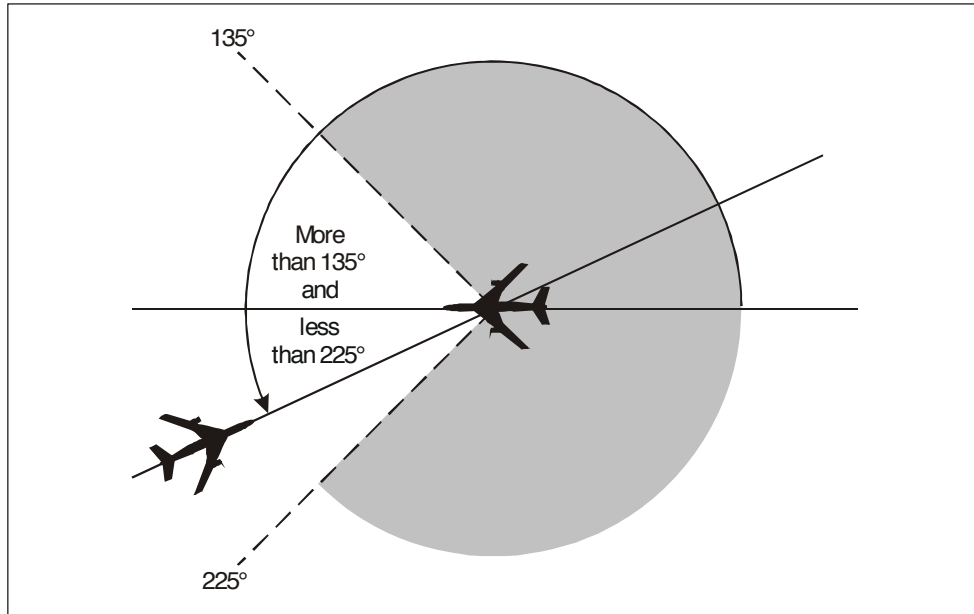

Figure 5-8. Aircraft on reciprocal tracks (see 5.4.2.1.5 b))

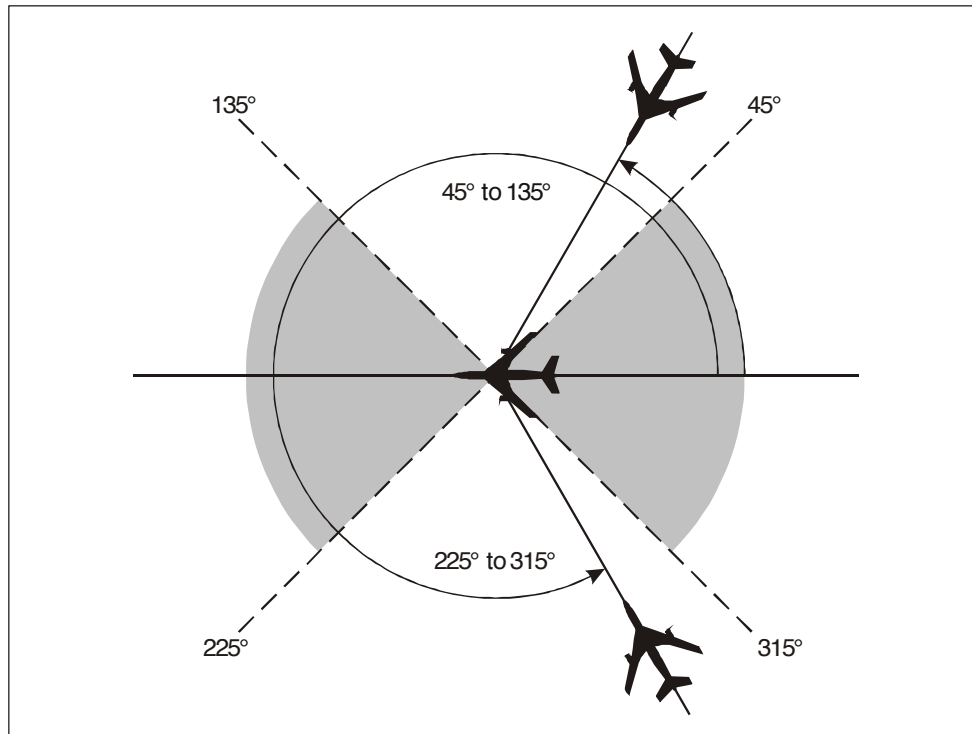

Figure 5-9. Aircraft on crossing tracks (see 5.4.2.1.5 c))

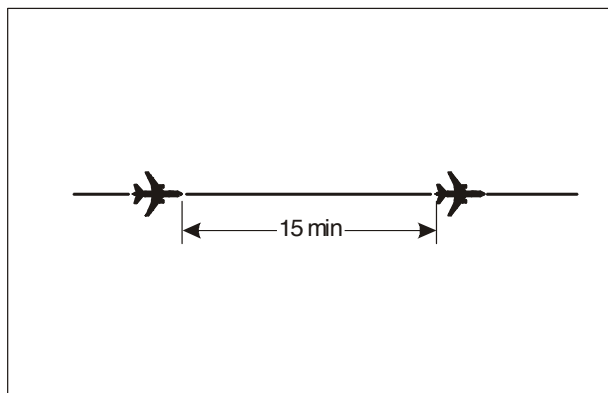

Figure 5-10. Fifteen-minute separation between aircraft on same track and same level (see 5.4.2.2.1.1 a))

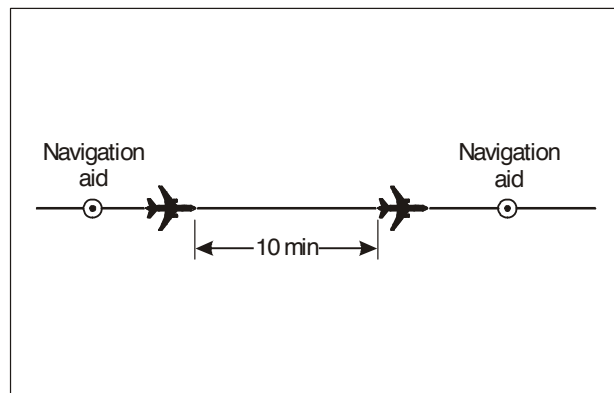

Figure 5-11. Ten-minute separation between aircraft on same track and same level (see 5.4.2.2.1.1 b))

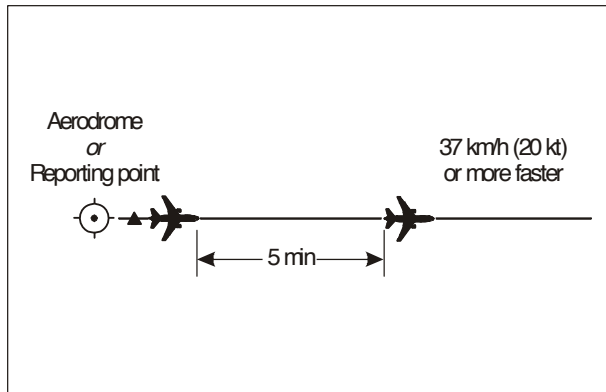

Figure 5-12. Five-minute separation between aircraft on same track and same level (see 5.4.2.2.1.1 c))

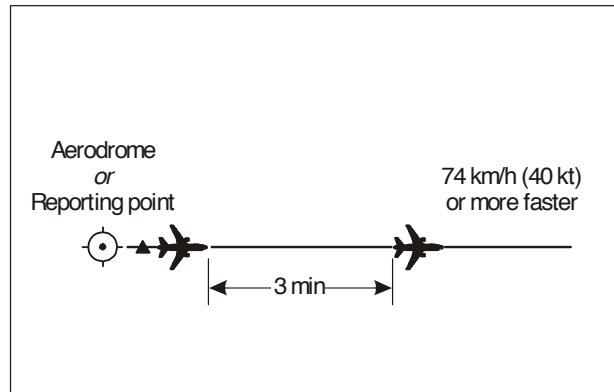

Figure 5-13. Three-minute separation between aircraft on same track and same level (see 5.4.2.2.1.1 d))

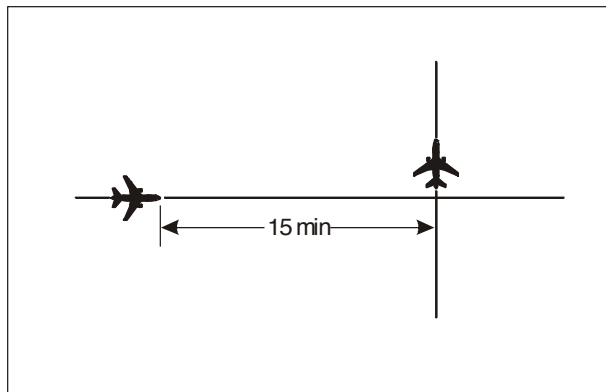

Figure 5-14. Fifteen-minute separation between aircraft on crossing tracks and same level (see 5.4.2.2.1.2 a))

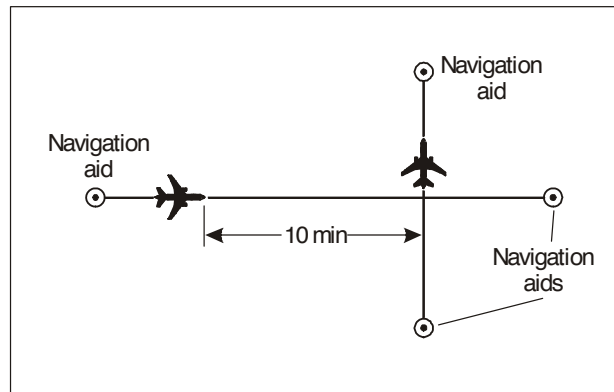

Figure 5-15. Ten-minute separation between aircraft on crossing tracks and same level (see 5.4.2.2.1.2 b))

5.4.2.2.2 AIRCRAFT CLIMBING OR DESCENDING

5.4.2.2.2.1 *Aircraft on the same track.* When an aircraft will pass through the level of another aircraft on the same track, the following minimum longitudinal separation shall be provided:

- a) 15 minutes while vertical separation does not exist (see Figures 5-16A and 5-16B); or
- b) 10 minutes while vertical separation does not exist, provided that such separation is authorized only where ground-based navigation aids or GNSS permit frequent determination of position and speed (see Figures 5-17A and 5-17B); or
- c) 5 minutes while vertical separation does not exist, provided that:
 - 1) the level change is commenced within 10 minutes of the time the second aircraft has reported over a common point which must be derived from ground-based navigation aids or by GNSS; and

- 2) when issuing the clearance through third party communication or CPDLC a restriction shall be added to the clearance to ensure that the 10-minute condition is satisfied (see Figures 5-18A and 5-18B).

Note.— To facilitate application of the procedure where a considerable change of level is involved, a descending aircraft may be cleared to some convenient level above the lower aircraft, or a climbing aircraft to some convenient level below the higher aircraft, to permit a further check on the separation that will be obtained while vertical separation does not exist.

5.4.2.2.2 Aircraft on crossing tracks:

- a) 15 minutes while vertical separation does not exist (see Figures 5-19A and 5-19B); or
- b) 10 minutes while vertical separation does not exist if navigation aids permit frequent determination of position and speed (see Figures 5-20A and 5-20B).

5.4.2.2.3 Aircraft on reciprocal tracks. Where lateral separation is not provided, vertical separation shall be provided for at least ten minutes prior to and after the time the aircraft are estimated to pass, or are estimated to have passed (see Figure 5-21). Provided it has been determined that the aircraft have passed each other, this minimum need not apply.

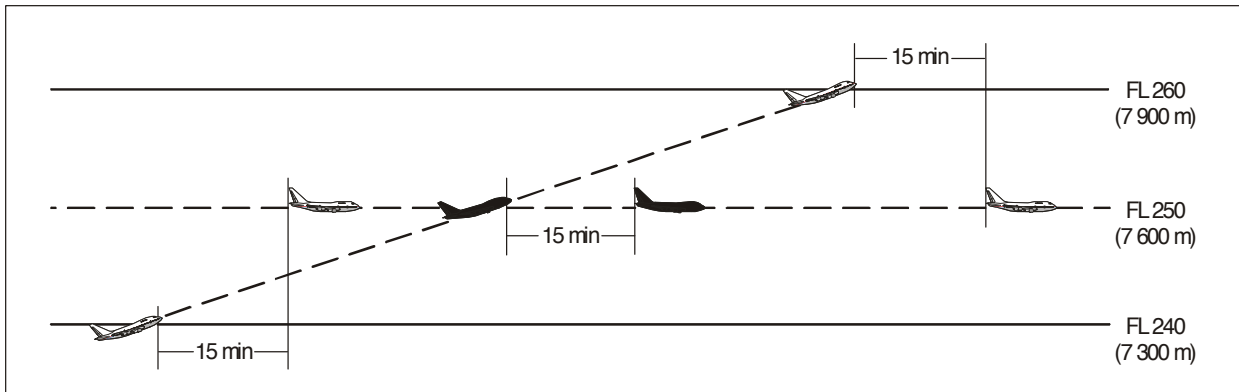

Figure 5-16A. Fifteen-minute separation between aircraft climbing and on same track (see 5.4.2.2.1 a))

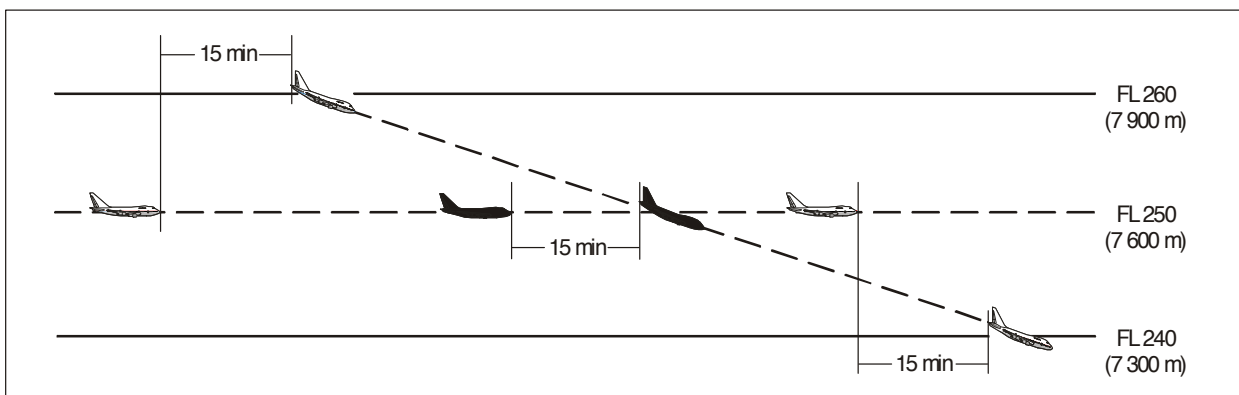

Figure 5-16B. Fifteen-minute separation between aircraft descending and on same track (see 5.4.2.2.1 a))

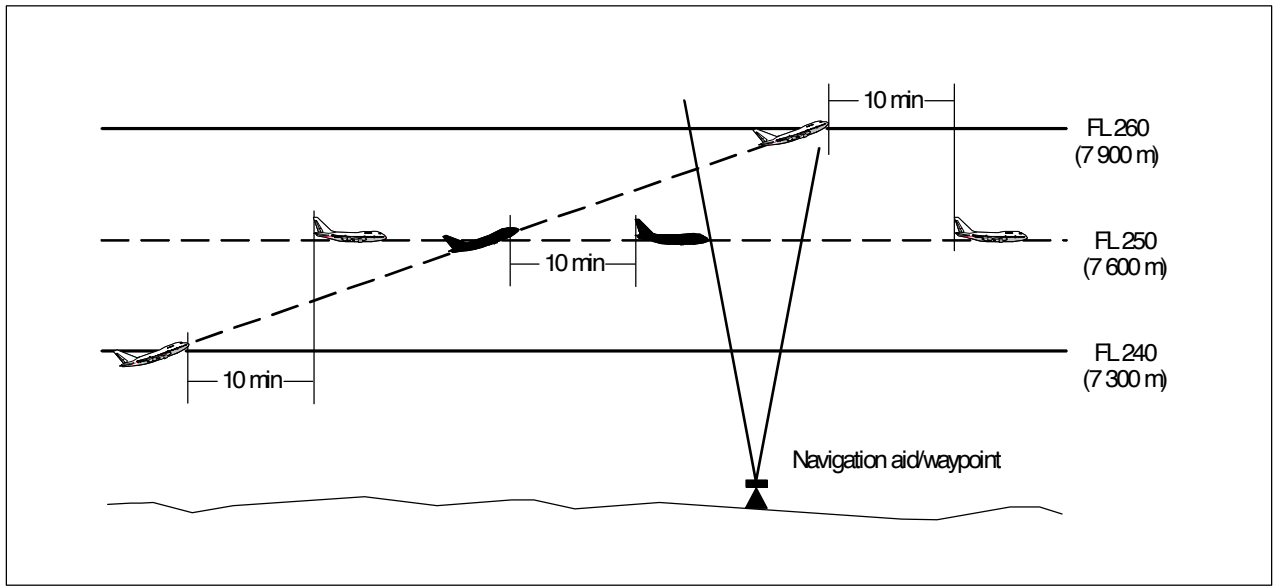

Figure 5-17A. Ten-minute separation between aircraft climbing and on same track (see 5.4.2.2.2.1 b))

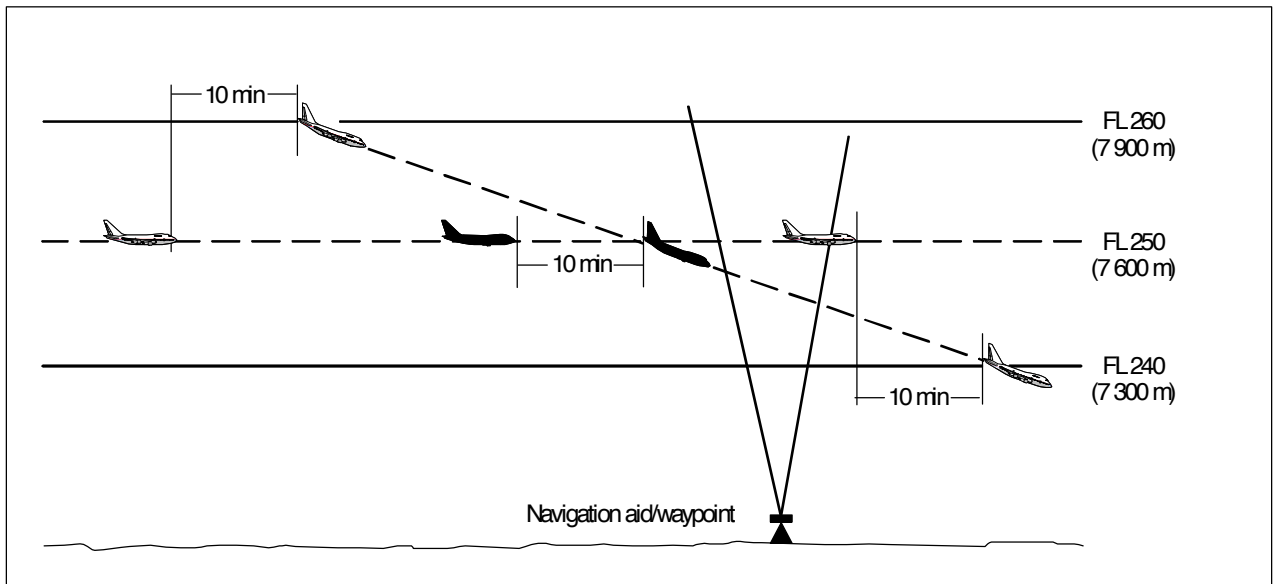

Figure 5-17B. Ten-minute separation between aircraft descending and on same track (see 5.4.2.2.2.1 b))

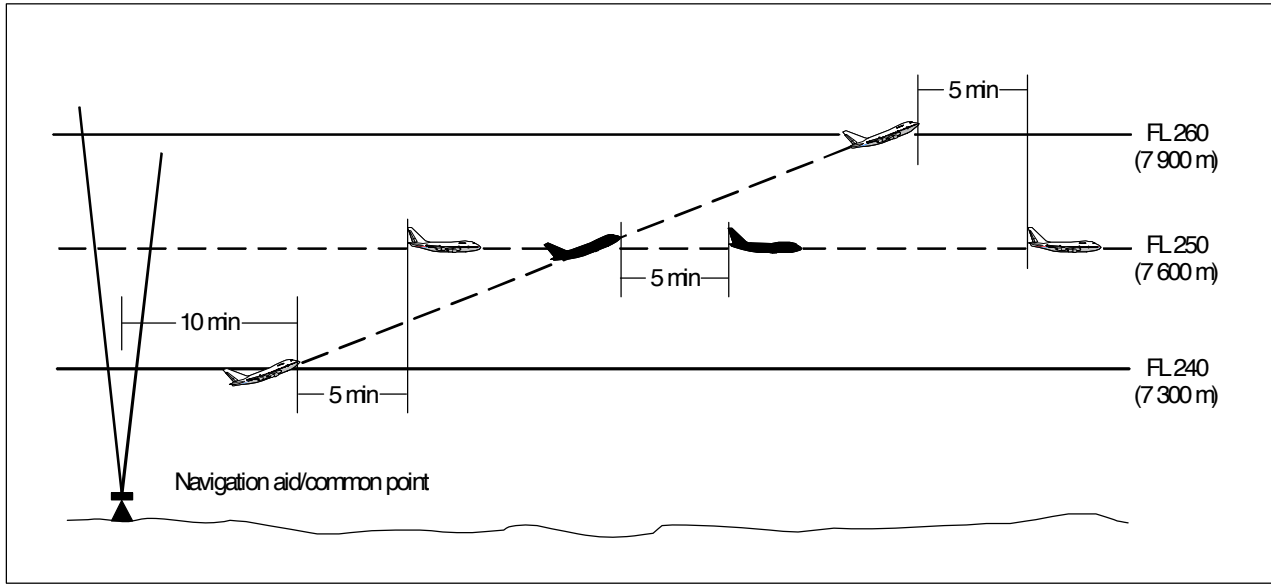

Figure 5-18A. Five-minute separation between aircraft climbing and on same track (see 5.4.2.2.1 c) 2))

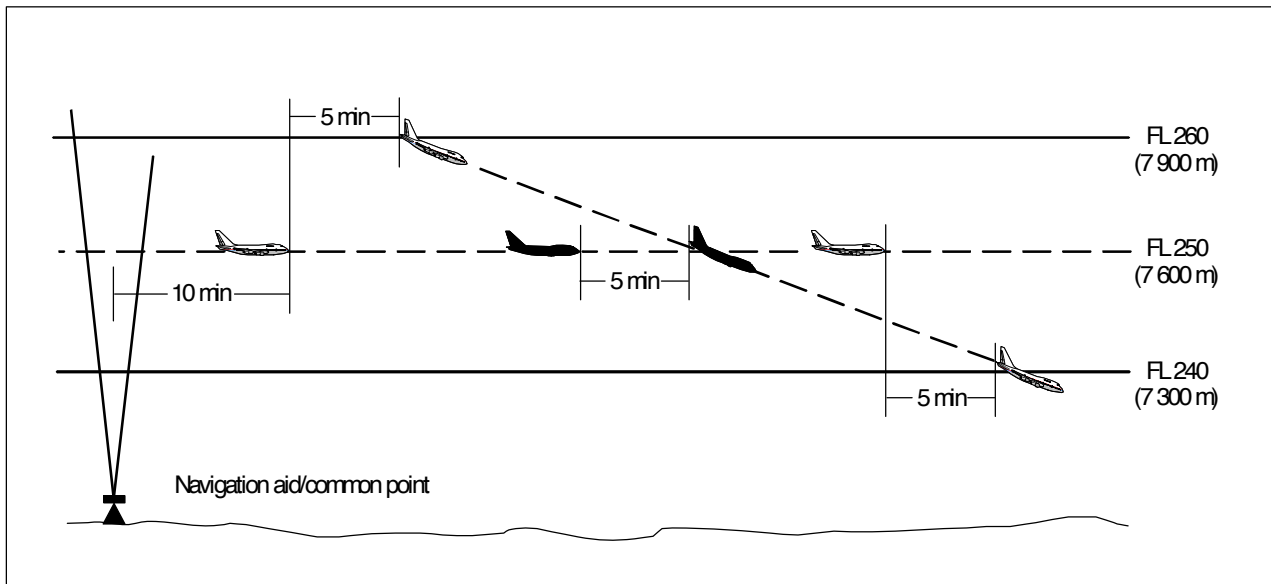

Figure 5-18B. Five-minute separation between aircraft descending and on same track (see 5.4.2.2.1 c) 2))

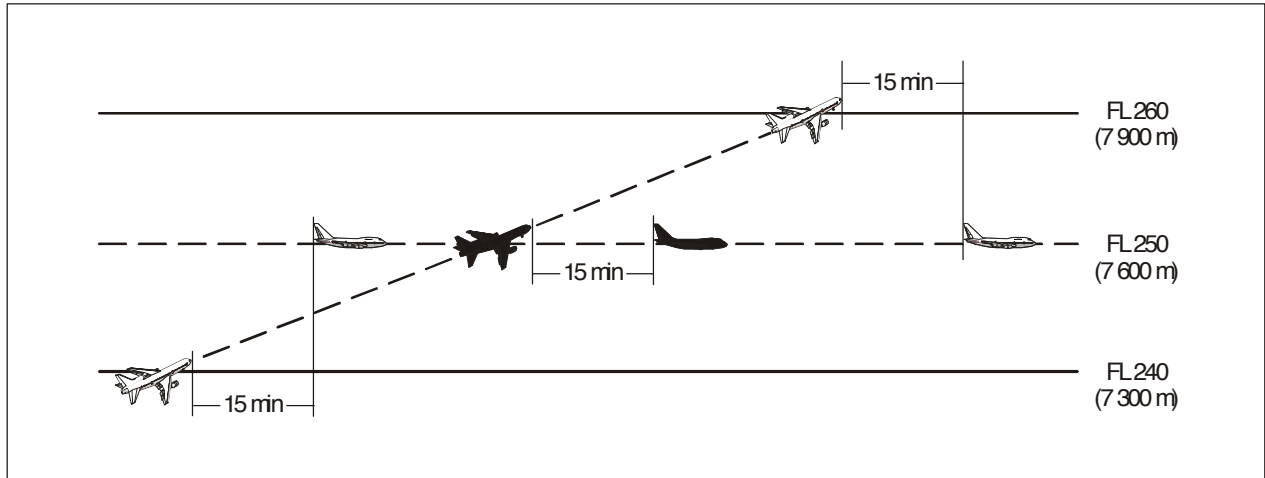

Figure 5-19A. Fifteen-minute separation between aircraft climbing and on crossing tracks (see 5.4.2.2.2 a)

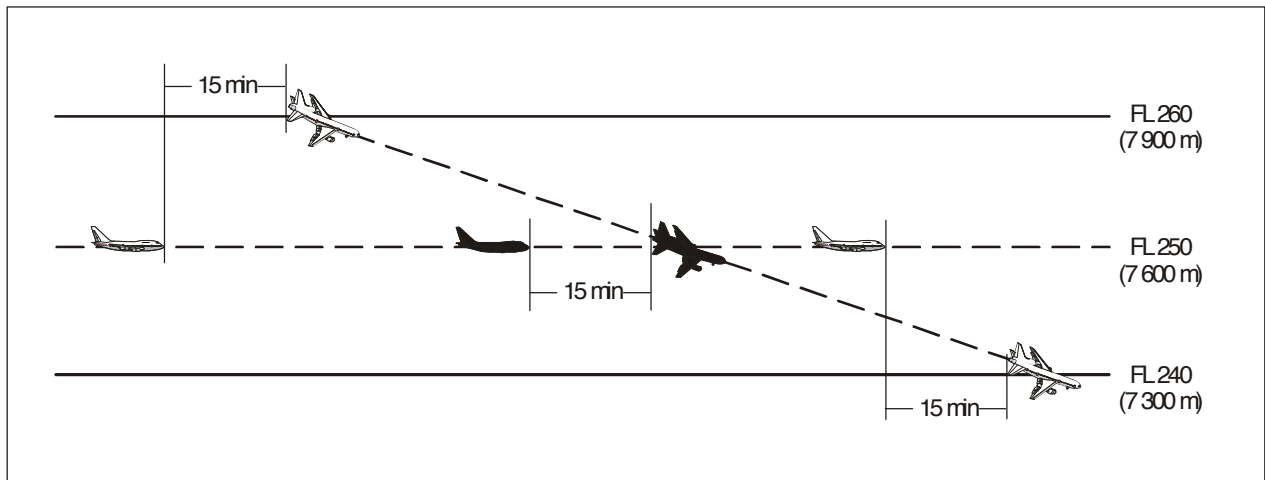

Figure 5-19B. Fifteen-minute separation between aircraft descending and on crossing tracks (see 5.4.2.2.2 a)

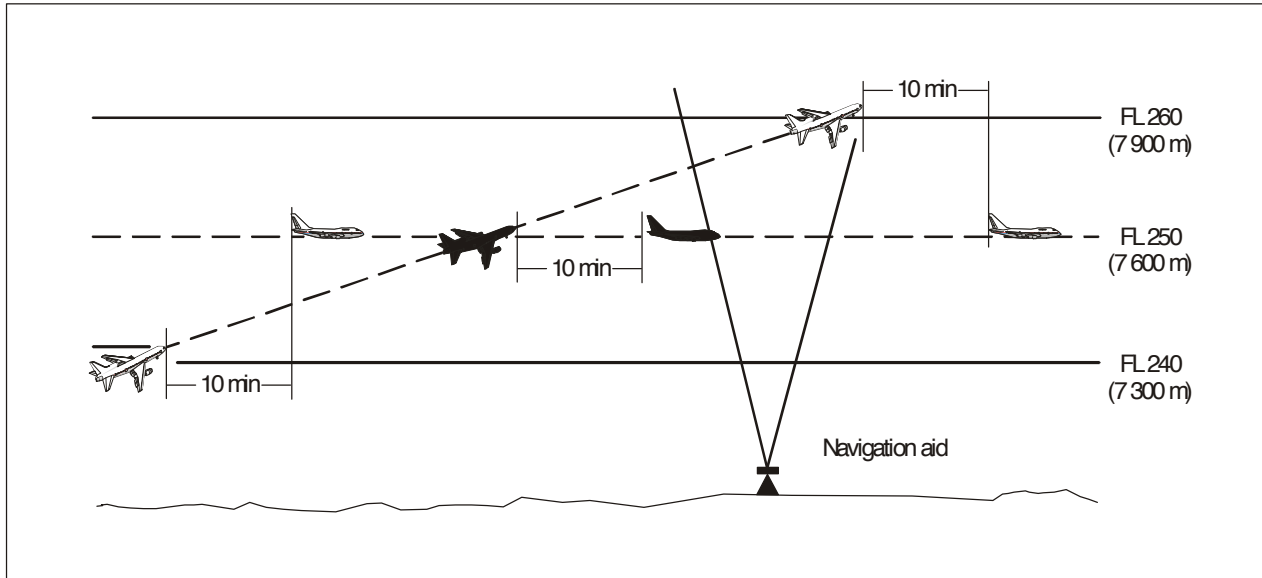

Figure 5-20A. Ten-minute separation between aircraft climbing and on crossing tracks (see 5.4.2.2.2 b))

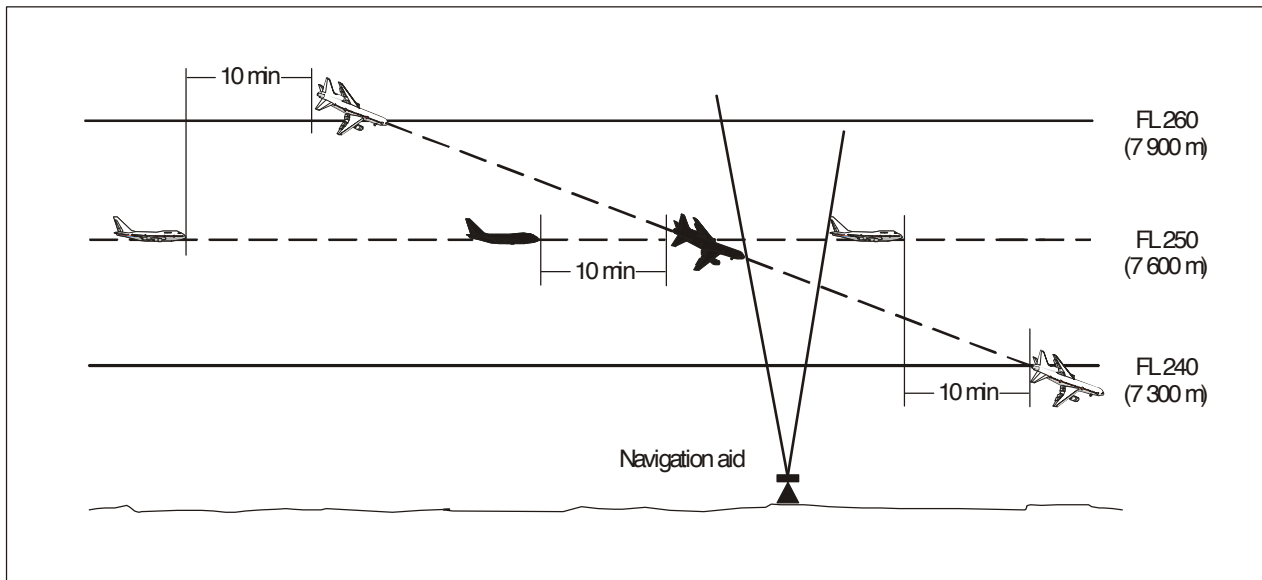

Figure 5-20B. Ten-minute separation between aircraft descending and on crossing tracks (see 5.4.2.2.2 b))

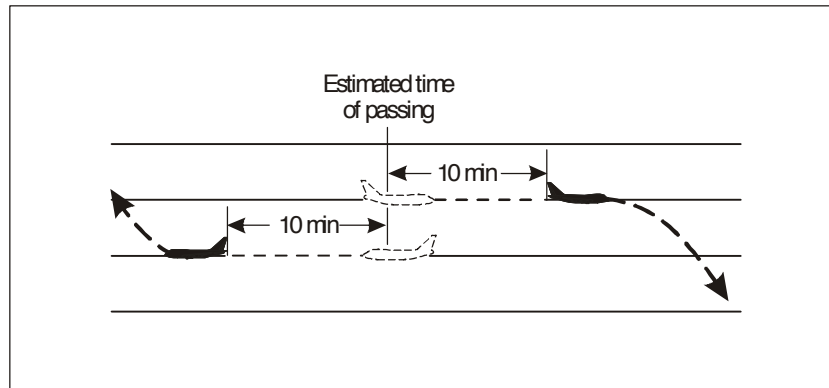

Figure 5-21. Ten-minute separation between aircraft on reciprocal tracks (see 5.4.2.2.3)

5.4.2.3 LONGITUDINAL SEPARATION MINIMA BASED ON DISTANCE USING DISTANCE MEASURING EQUIPMENT (DME) AND/OR GNSS

Note.— Where the term “on track” is used in the provisions relating to the application of longitudinal separation minima using DME and/or GNSS, it means that the aircraft is flying either directly inbound to or directly outbound from the station/waypoint.

5.4.2.3.1 Separation shall be established by maintaining not less than specified distance(s) between aircraft positions as reported by reference to DME in conjunction with other appropriate navigation aids and/or GNSS. This type of separation shall be applied between two aircraft using DME, or two aircraft using GNSS, or one aircraft using DME and one aircraft using GNSS. Direct controller-pilot VHF voice communication shall be maintained while such separation is used.

Note.— For the purpose of applying GNSS-based separation minimum, a distance derived from an integrated navigation system incorporating GNSS input is regarded as equivalent to GNSS distance.

5.4.2.3.2 When applying these separation minima between any aircraft with area navigation capability, controllers shall specifically request GNSS-derived distance.

Note.— Reasons making a pilot unable to provide GNSS distance information may include inadequate on-board equipment, no GNSS input into an integrated navigation system, or a loss of GNSS integrity.

5.4.2.3.3 AIRCRAFT AT THE SAME CRUISING LEVEL

5.4.2.3.3.1 Aircraft on the same track:

a) 37 km (20 NM), provided:

1) each aircraft utilizes:

i) the same “on-track” DME station when both aircraft are utilizing DME; or

ii) an “on-track” DME station and a collocated waypoint when one aircraft is utilizing DME and the other is utilizing GNSS; or

- iii) the same waypoint when both aircraft are utilizing GNSS; and
- 2) separation is checked by obtaining simultaneous DME and/or GNSS readings from the aircraft at frequent intervals to ensure that the minimum will not be infringed (see Figure 5-22);

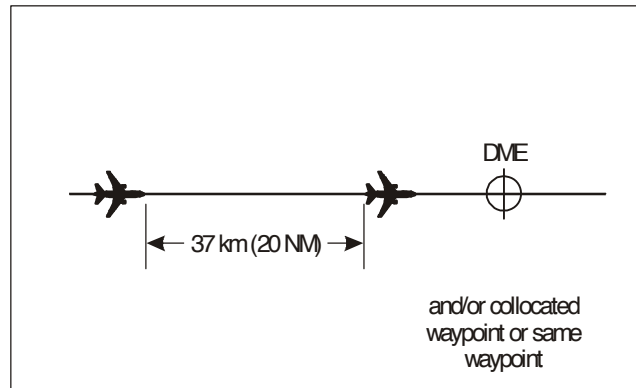

Figure 5-22. 37 km (20 NM) DME and/or GNSS-based separation between aircraft on same track and same level (see 5.4.2.3.3.1 a))

- b) 19 km (10 NM), provided:
 - 1) the leading aircraft maintains a true airspeed of 37 km/h (20 kt) or more faster than the succeeding aircraft;
 - 2) each aircraft utilizes:
 - i) the same “on-track” DME station when both aircraft are utilizing DME; or
 - ii) an “on-track” DME station and a collocated waypoint when one aircraft is utilizing DME and the other is utilizing GNSS; or
 - iii) the same waypoint when both aircraft are utilizing GNSS; and
 - 3) separation is checked by obtaining simultaneous DME and/or GNSS readings from the aircraft at such intervals as are necessary to ensure that the minimum is established and will not be infringed (see Figure 5-23).

5.4.2.3.3.2 *Aircraft on crossing tracks.* The longitudinal separation prescribed in 5.4.2.3.3.1 shall also apply provided each aircraft reports distance from the DME station and/or collocated waypoint or same waypoint located at the crossing point of the tracks and that the relative angle between the tracks is less than 90 degrees (see Figures 5-24A and 5-24B).

5.4.2.3.4 AIRCRAFT CLIMBING AND DESCENDING

5.4.2.3.4.1 *Aircraft on the same track:* 19 km (10 NM) while vertical separation does not exist, provided:

- a) each aircraft utilizes:

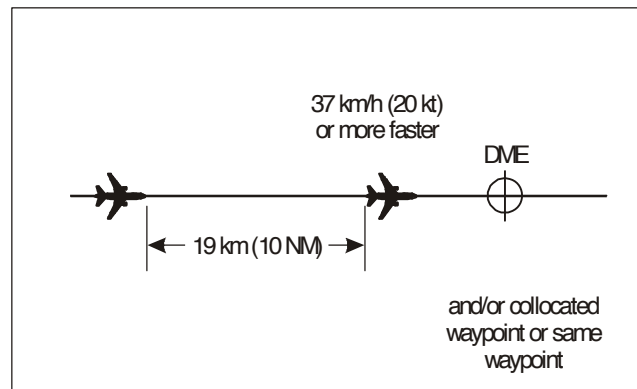

Figure 5-23. 19 km (10 NM) DME and/or GNSS-based separation between aircraft on same track and same level (see 5.4.2.3.3.1 b))

- i) the same “on-track” DME station when both aircraft are utilizing DME; or
 - ii) an “on-track” DME station and a collocated waypoint when one aircraft is utilizing DME and the other is utilizing GNSS; or
 - iii) the same waypoint when both aircraft are utilizing GNSS; and
- b) one aircraft maintains a level while vertical separation does not exist; and
 - c) separation is established by obtaining simultaneous DME and/or GNSS readings from the aircraft (see Figures 5-25A and 5-25B).

Note.— To facilitate application of the procedure where a considerable change of level is involved, a descending aircraft may be cleared to some convenient level above the lower aircraft, or a climbing aircraft to some convenient level below the higher aircraft, to permit a further check on the separation that will be obtained while vertical separation does not exist.

5.4.2.3.4.2 *Aircraft on reciprocal tracks.* Aircraft utilizing on-track DME and/or collocated waypoint or same waypoint may be cleared to climb or descend through the levels occupied by other aircraft utilizing on-track DME and/or collocated waypoint or same waypoint, provided that it has been positively established that the aircraft have passed each other and are at least 10 NM apart, or such other value as prescribed by the appropriate ATS authority.

5.4.2.4 LONGITUDINAL SEPARATION MINIMA WITH MACH NUMBER TECHNIQUE BASED ON TIME

5.4.2.4.1 Turbojet aircraft shall adhere to the true Mach number approved by ATC and shall request ATC approval before making any changes thereto. If it is essential to make an immediate temporary change in the Mach number (e.g. due to turbulence), ATC shall be notified as soon as possible that such a change has been made.

5.4.2.4.2 If it is not feasible, due to aircraft performance, to maintain the last assigned Mach number during en-route climbs and descents, pilots of aircraft concerned shall advise ATC at the time of the climb/descent request.

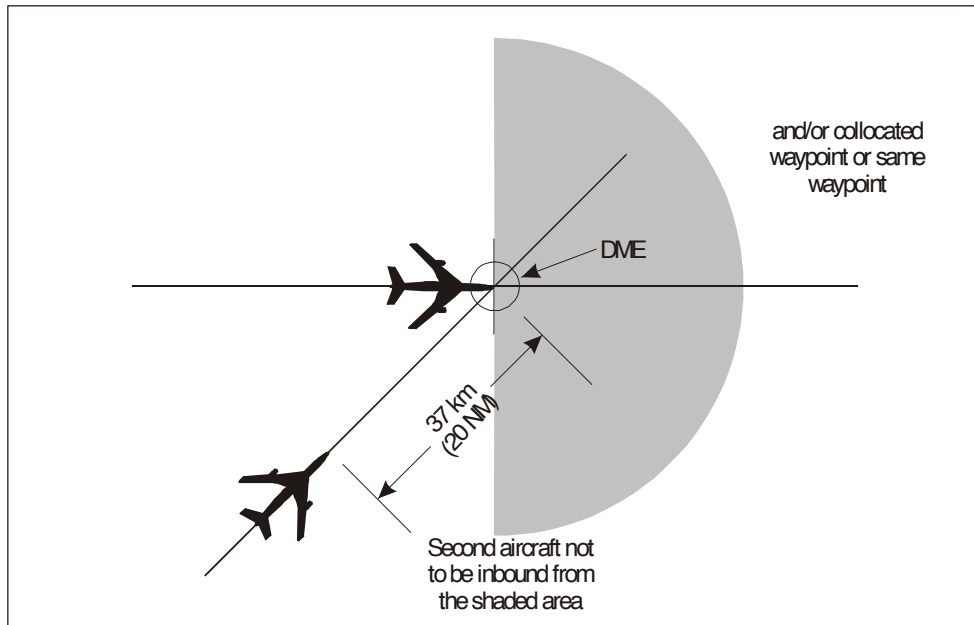

Figure 5-24A. 37 km (20 NM) DME and/or GNSS-based separation between aircraft on crossing tracks and same level (see 5.4.2.3.3.2)

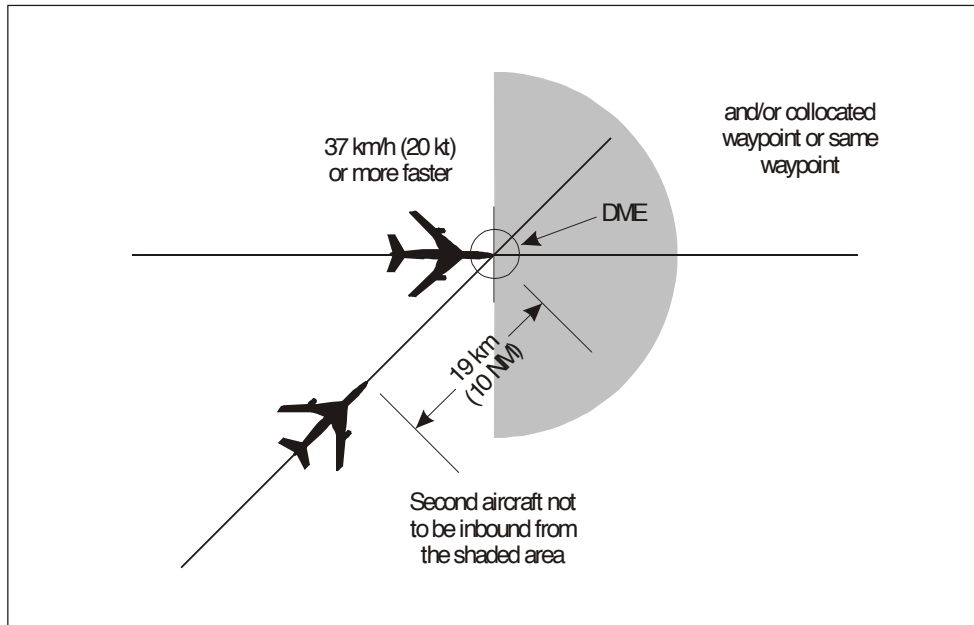

Figure 5-24B. 19 km (10 NM) DME and/or GNSS-based separation between aircraft on crossing tracks and same level (see 5.4.2.3.3.2)

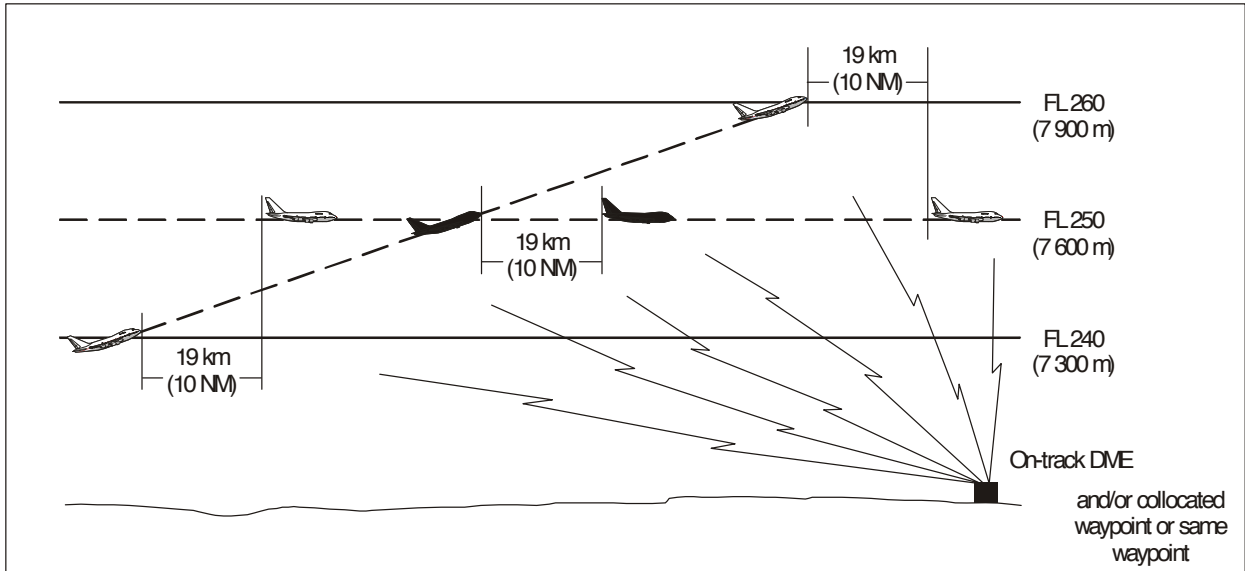

Figure 5-25A. 19 km (10 NM) DME and/or GNSS-based separation between aircraft climbing and on same track (see 5.4.2.3.4.1 c)

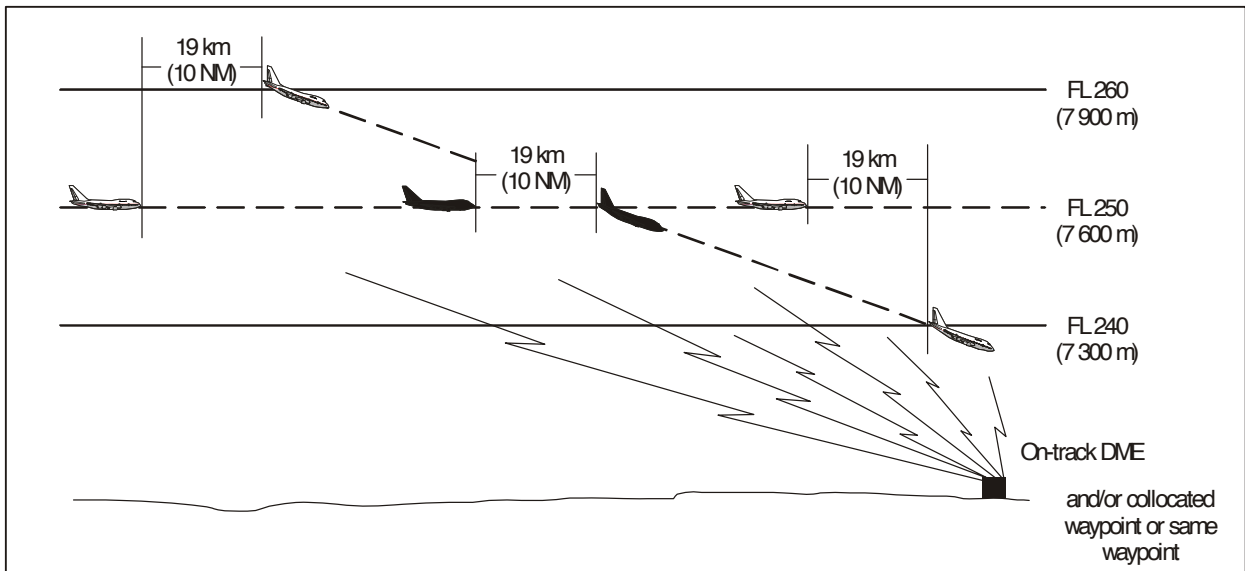

Figure 5-25B. 19 km (10 NM) DME and/or GNSS-based separation between aircraft descending and on same track (see 5.4.2.3.4.1 c)

5.4.2.4.3 When the Mach number technique is applied and provided that:

- a) the aircraft concerned have reported over the same common point and follow the same track or continuously diverging tracks until some other form of separation is provided; or
- b) if the aircraft have not reported over the same common point and it is possible to ensure, by radar, ADS-B or other means, that the appropriate time interval will exist at the common point from which they either follow the same track or continuously diverging tracks;

minimum longitudinal separation between turbojet aircraft on the same track, whether in level, climbing or descending flight shall be:

- 1) 10 minutes; or
- 2) between 9 and 5 minutes inclusive, provided that:

the preceding aircraft is maintaining a true Mach number greater than the following aircraft in accordance with the following:

- 9 minutes, if the preceding aircraft is Mach 0.02 faster than the following aircraft;
- 8 minutes, if the preceding aircraft is Mach 0.03 faster than the following aircraft;
- 7 minutes, if the preceding aircraft is Mach 0.04 faster than the following aircraft;
- 6 minutes, if the preceding aircraft is Mach 0.05 faster than the following aircraft;
- 5 minutes, if the preceding aircraft is Mach 0.06 faster than the following aircraft.

5.4.2.4.4 When the 10-minute longitudinal separation minimum with Mach number technique is applied, the preceding aircraft shall maintain a true Mach number equal to or greater than that maintained by the following aircraft.

5.4.2.5 LONGITUDINAL SEPARATION MINIMA WITH MACH NUMBER TECHNIQUE BASED ON DISTANCE USING RNAV

Note.— Guidance material on RNAV operations is contained in the Performance-based Navigation (PBN) Manual (Doc 9613).

5.4.2.5.1 Turbojet aircraft shall adhere to the true Mach number approved by ATC and shall request ATC approval before making any changes thereto. If it is essential to make an immediate temporary change in the Mach number (e.g. due to turbulence), ATC shall be notified as soon as possible that such a change has been made.

5.4.2.5.1.1 If it is not feasible, due to aircraft performance, to maintain the last assigned Mach number during en-route climbs and descents, pilots of aircraft concerned shall advise ATC at the time of the climb/descent request.

5.4.2.5.2 RNAV distance-based separation minima shall not be applied after ATC has received pilot advice indicating navigation equipment deterioration or failure.

5.4.2.5.3 Separation shall be established by maintaining not less than the specified distance between aircraft positions as reported by reference to RNAV equipment. Direct controller-pilot communications should be maintained, while such separation is used. Where high frequency or general purpose extended range very high frequency air-ground communication channels are used for area control service and are worked by air-ground communicators, suitable arrangements shall be made to permit direct controller-pilot communications, or monitoring by the controller of all air-ground communications.

5.4.2.5.3.1 To assist pilots to readily provide the required RNAV distance information, such position reports should, wherever possible, be referenced to a common waypoint ahead of both aircraft.

5.4.2.5.4 RNAV distance-based separation may be applied between RNAV-equipped aircraft when operating on designated RNAV routes or on ATS routes defined by VOR.

5.4.2.5.5 A 150 km (80 NM) RNAV distance-based separation minimum with Mach number technique may be used on same-direction tracks in lieu of a 10-minute longitudinal separation minimum with Mach number technique, provided:

- a) each aircraft reports its distance to or from the same “on-track” common point;
- b) separation between aircraft at the same level is checked by obtaining simultaneous RNAV distance readings from the aircraft at frequent intervals to ensure that the minimum will not be infringed (see Figure 5-26);
- c) separation between aircraft climbing or descending is established by obtaining simultaneous RNAV distance readings from the aircraft (see Figures 5-27A and 5-27B); and
- d) in the case of aircraft climbing or descending, one aircraft maintains a level while vertical separation does not exist.

5.4.2.5.6 When the 150 km (80 NM) longitudinal separation minimum with Mach number technique is applied, the preceding aircraft shall maintain a true Mach number equal to or greater than that maintained by the following aircraft.

Note.— To facilitate application of the procedure where a considerable change of level is involved, a descending aircraft may be cleared to some convenient level above the lower aircraft, or a climbing aircraft to some convenient level below the higher aircraft, to permit a further check on the separation that will be obtained while vertical separation does not exist.

5.4.2.5.7 *Aircraft on reciprocal tracks.* Aircraft utilizing RNAV may be cleared to climb or descend to or through the levels occupied by other aircraft utilizing RNAV provided it has been positively established by simultaneous RNAV distance readings to or from the same “on-track” common point that the aircraft have passed each other and are at least 150 km (80 NM) apart (see Figure 5-28).

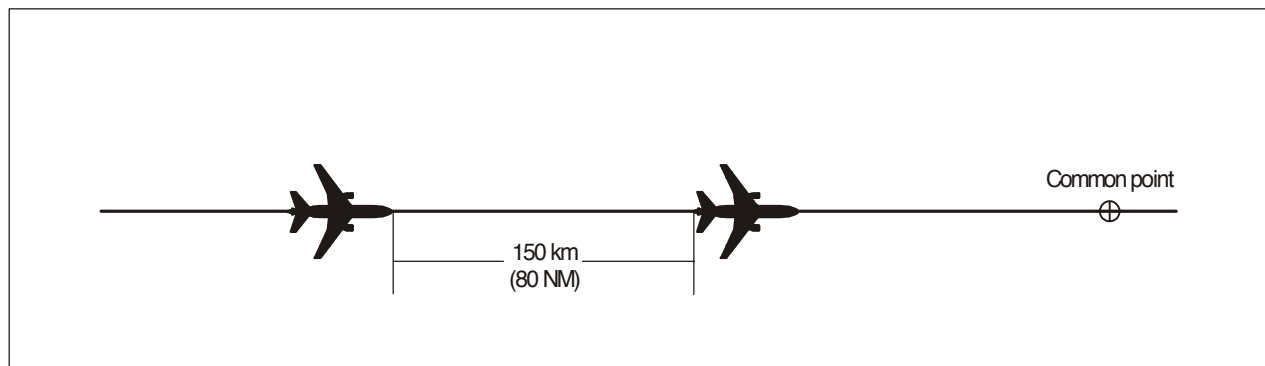

Figure 5-26. 150 km (80 NM) RNAV-based separation between aircraft at the same level (see 5.4.2.5.5 b))

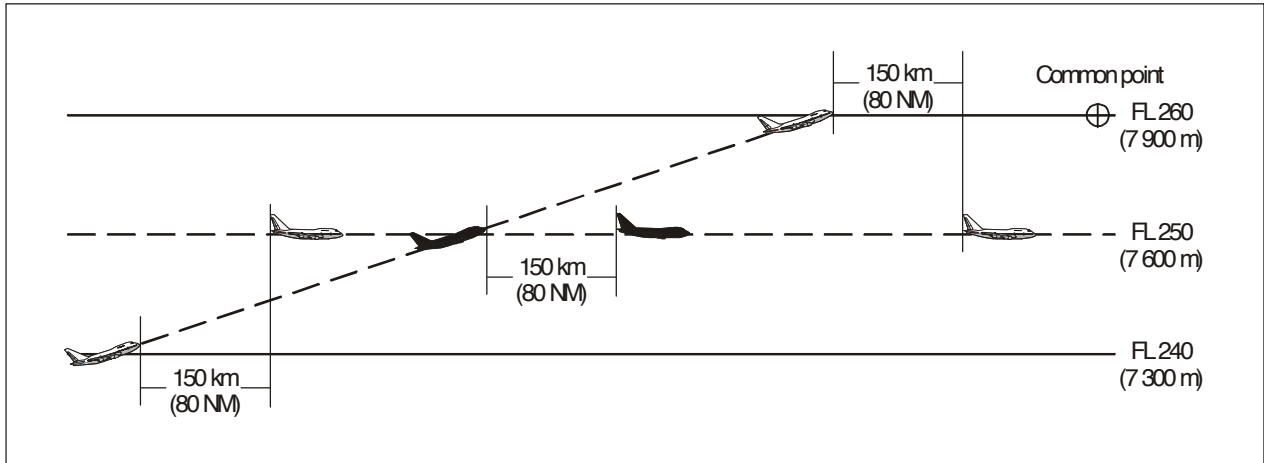

Figure 5-27A. 150 km (80 NM) RNAV-based separation between aircraft climbing and on same track (see 5.4.2.5.5 c)

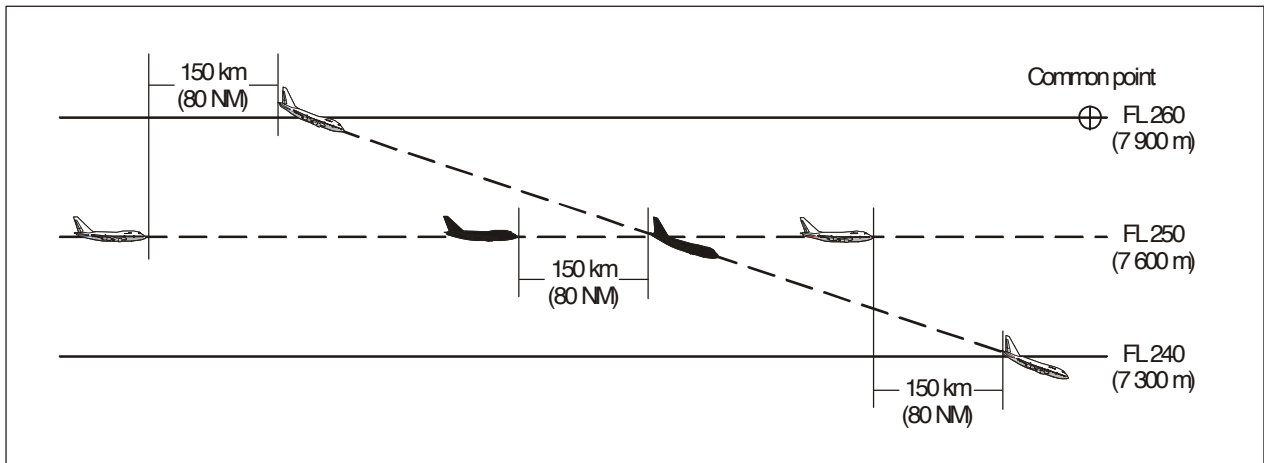

Figure 5-27B. 150 km (80 NM) RNAV-based separation between aircraft descending and on same track (see 5.4.2.5.5 c)

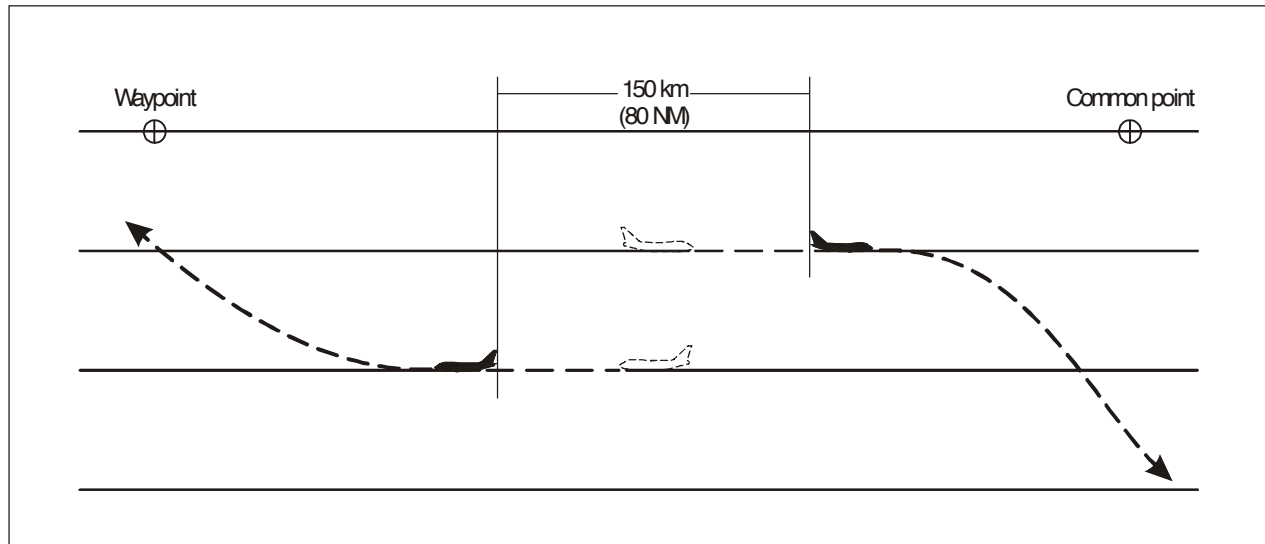

Figure 5-28. 150 km (80 NM) RNAV-based separation between aircraft on reciprocal tracks (see 5.4.2.5.7)

5.4.2.6 LONGITUDINAL SEPARATION MINIMA BASED ON DISTANCE USING RNAV WHERE RNP IS SPECIFIED

Note.— Guidance material is contained in Attachment B to Annex 11, the Performance-based Navigation (PBN) Manual (Doc 9613), the Air Traffic Services Planning Manual (Doc 9426) and the Manual on Airspace Planning Methodology for the Determination of Separation Minima (Doc 9689).

5.4.2.6.1 Within designated airspace, or on designated routes, separation minima in accordance with the provisions of this section (5.4.2.6) may be used, subject to regional air navigation agreements.

5.4.2.6.2 Separation shall be established by maintaining not less than the specified distance between aircraft positions as reported by reference to the same “on-track” common point, whenever possible ahead of both aircraft, or by means of an automated position reporting system.

Note.— The term “on track” means that the aircraft is flying either directly inbound to or directly outbound from the station or waypoint.

5.4.2.6.2.1 When information is received indicating navigation equipment failure or deterioration below the navigation performance requirements, ATC shall then, as required, apply alternative separation minima.

5.4.2.6.2.2 Direct controller-pilot communications shall be maintained while applying a distance-based separation minima. Direct controller-pilot communications shall be voice or CPDLC. The communication criteria necessary for CPDLC to satisfy the requirement for direct controller-pilot communications shall be established by an appropriate safety assessment.

Note.— The communication criteria which are used as a basis for the derivation of the separation minima in this section are set out in Appendix 5 of the Manual on Airspace Planning Methodology for the Determination of Separation Minima (Doc 9689). Guidance material for CPDLC is contained in the Manual of Air Traffic Services Data Link Applications (Doc 9694).

5.4.2.6.2.2.1 Prior to and during the application of a distance-based separation minimum, the controller should determine the adequacy of the available communication link, considering the time element required to receive replies from two or more aircraft, and the overall workload/traffic volume associated with the application of such minima.

5.4.2.6.2.3 When aircraft are at, or are expected to reduce to, the minimum separation applicable, speed control techniques, including assigning Mach number, shall be applied to ensure that the minimum distance exists throughout the period of application of the minima.

5.4.2.6.3 *LONGITUDINAL DISTANCE-BASED SEPARATION MINIMA
IN AN RNP RNAV ENVIRONMENT NOT USING ADS-C*

5.4.2.6.3.1 For aircraft cruising, climbing or descending on the same track, the following separation minimum may be used:

<i>Separation minimum</i>	<i>RNP type</i>	<i>Communication requirement</i>	<i>Surveillance requirement</i>	<i>Distance verification requirements</i>
93 km (50 NM)	10	Direct controller-pilot communications	Procedural position reports	At least every 24 minutes

Note 1.— Where a considerable change of level is involved using distance-based separation, a descending aircraft may be cleared to some convenient level above the lower aircraft, or a climbing aircraft to some convenient level below the higher aircraft (e.g. 1 200 m (4 000 ft) or less) to permit a further check on the separation that will be maintained while vertical separation does not exist.

Note 2.— It should be noted that the separation minimum depicted above is based on safety assessments performed specifically for a particular network of tracks or routes. As such, the assessments evaluated traffic characteristics which might be unique to the network being assessed.

Note 3.— The separation minimum above was developed in accordance with a collision risk analysis which dictates conditions under which this separation can be applied.

Note 4.— Detailed information on the analysis used to determine the separation minimum and on performing safety assessments is contained in the Manual on Airspace Planning Methodology for the Determination of Separation Minima (Doc 9689).

5.4.2.6.3.2 During the application of the 93 km (50 NM) separation, when an aircraft fails to report its position, the controller shall take action within 3 minutes to establish communication. If communication has not been established within 8 minutes of the time the report should have been received, the controller shall take action to apply an alternative form of separation.

5.4.2.6.3.3 Where automated position reporting applies, a common time reference shall be used.

5.4.2.6.3.4 *Aircraft on reciprocal tracks.* Aircraft may be cleared to climb or descend to or through the levels occupied by the other provided that it has been positively established that the aircraft have passed each other and the distance between them is equal to at least the applicable separation minimum.

5.4.2.7 LONGITUDINAL SEPARATION MINIMA BASED ON DISTANCE
USING ADS-B IN-TRAIL PROCEDURE (ITP)

Note 1.— Attention is drawn to Circular 325, In-Trail Procedure (ITP) Using Automatic Dependent Surveillance — Broadcast (ADS-B).

Note 2.— Guidance material on ITP equipment can be found in RTCA DO-312/EUROCAE ED-159 Safety Performance and Interoperability Requirements Document for the In-Trail Procedure in Oceanic Airspace (ATSA-ITP) Application and Supplement and RTCA DO-317A/EUROCAE ED-194, Minimum Operational Performance Standards (MOPS) for Aircraft Surveillance Application (ASA) System.

5.4.2.7.1 The routes or airspace where application of the in-trail procedure is authorized, and the procedures to be followed by pilots in accordance with the provisions of Section 5.4.2.7, shall be promulgated in aeronautical information publications (AIPs).

5.4.2.7.2 ITP requests and clearances shall be communicated via a CPDLC message exchange only and in accordance with the appropriate message elements in Appendix 5.

5.4.2.7.3 Longitudinal separation between a climbing or descending ITP aircraft and reference aircraft shall be applied in accordance with 5.4.2.7.3.1, 5.4.2.7.3.2 and 5.4.2.7.3.3. An ITP aircraft shall not be separated simultaneously from more than two reference aircraft using the ITP separation minimum (see Figure 5-29).

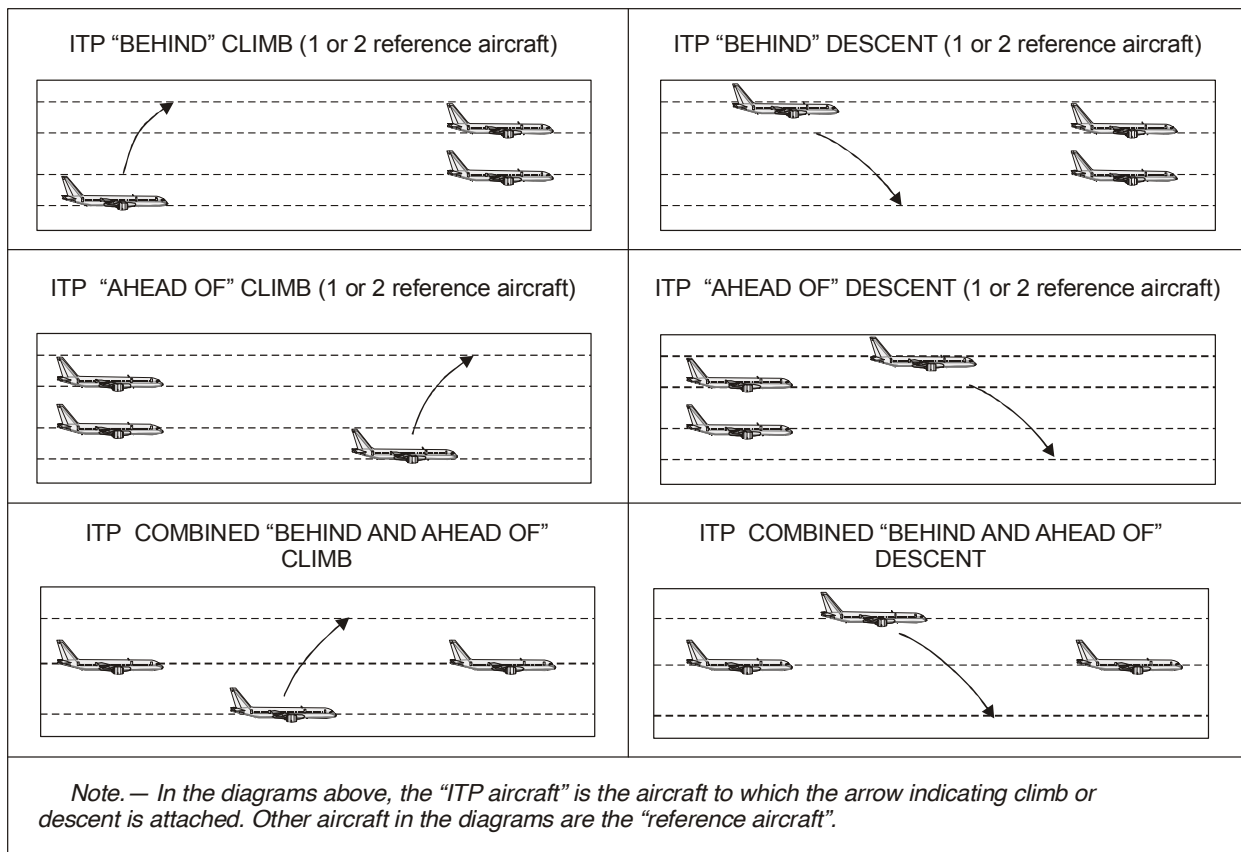

Figure 5-29. ITP flight level change scenarios (see 5.4.2.7.3)

5.4.2.7.3.1 An ITP climb or descent may be requested by the pilot provided the following ITP criteria are satisfied:

- a) the ITP distance between the ITP aircraft and the reference aircraft shall be:
 - 1) not less than 28 km (15 NM) with a maximum closing ground speed of 37 km/h (20 kt); or
 - 2) not less than 37 km (20 NM) with a maximum closing ground speed of 56 km/h (30 kt);
- b) the ITP on-board equipment shall indicate that the angle between the current tracks of the ITP aircraft and reference aircraft is less than 45 degrees;
- c) the altitude difference between the ITP aircraft and any reference aircraft shall be 600 m (2 000 ft) or less;
- d) the climb or descent shall be conducted at a rate of not less than 1.5 m/s (300 ft/min), or any higher rate when specified by the controller; and
- e) the climb or descent shall be performed at the assigned Mach number. If no Mach number has been assigned by ATC, the ITP aircraft shall maintain the current cruise Mach number throughout the ITP manoeuvre.

Note.— These criteria are designed to ensure a minimum separation of 19 km (10 NM) between the ITP aircraft and the reference aircraft during the climb or descent.

5.4.2.7.3.2 A controller may clear an aircraft for an ITP climb or descent provided the following conditions are satisfied:

- a) the ITP climb or descent has been requested by the pilot;
- b) the aircraft identification of each reference aircraft in the ITP request exactly matches the Item 7 — aircraft identification of the corresponding aircraft's filed flight plan;
- c) the reported ITP distance between the ITP aircraft and any reference aircraft is 28 km (15 NM) or more;
- d) both the ITP aircraft and reference aircraft are either on:
 - 1) same identical tracks and any turn at a waypoint shall be limited to less than 45 degrees; or
 - 2) parallel tracks or same tracks with no turns permitted during the manoeuvre.

Note.— Same identical tracks are a special case of same track defined in 5.4.2.1.5 a) where the angular difference is zero degrees.

- e) no speed or route change clearance shall be issued to the ITP aircraft until the ITP climb or descent is completed;
- f) the altitude difference between the ITP aircraft and any reference aircraft shall be 600 m (2 000 ft) or less;
- g) no instruction to amend speed, altitude or route shall be issued to any reference aircraft until the ITP climb or descent is completed;
- h) the maximum closing speed between the ITP aircraft and each reference aircraft shall be Mach 0.06; and
- i) the ITP aircraft shall not be a reference aircraft in another ITP clearance.

5.4.2.7.3.3 Following receipt of an ITP climb or descent clearance and before initiating the procedure, the pilot of the ITP aircraft shall determine that the ITP criteria referred to in 5.4.2.7.3.1 a) and b) are still being met with respect to the reference aircraft identified in the clearance and:

- a) if the ITP criteria are satisfied, the pilot shall accept the clearance and commence the climb or descent immediately; or
- b) if the ITP criteria are no longer satisfied, the pilot shall notify the controller and maintain the previously cleared level.

5.4.2.8 LONGITUDINAL SEPARATION MINIMA BASED ON DISTANCE USING ADS-C CLIMB AND DESCEND PROCEDURE (CDP)

5.4.2.8.1 When an aircraft on the same track is cleared to climb or descend through the level of another aircraft, the clearance should be issued provided the following requirements are met:

- a) the longitudinal distance between the aircraft is determined by the ground automation system from near-simultaneous demand ADS-C reports which contain position accuracy of 0.25 NM or better (Figure of Merit 6 or higher);

Note.— Refer to 5.4.2.9.5 for distance calculations.

- b) the longitudinal distance between the aircraft, as determined in a) above, is not less than:
 - 1) 27.8 km (15 NM) when the preceding aircraft is at the same speed or faster than the following aircraft; or
 - 2) 46.3 km (25 NM) when the following aircraft is not more than either 18.5 km/h (10 kt) or Mach 0.02 faster than the preceding aircraft;
- c) the altitude difference between aircraft is not greater than 600 m (2 000 ft);
- d) the clearance is issued with a restriction that ensures vertical separation is re-established within 15 minutes from the first demand report request; and
- e) direct controller-pilot voice communications or CPDLC is maintained.

5.4.2.8.2 The application of the ADS-C climb and descend procedure (CDP) should be supported by an ongoing monitoring process.

Note.— Supporting information on ongoing monitoring is provided in Circular 342, Automatic Dependent Surveillance — Contract (ADS-C) Climb and Descend Procedure (CDP).

5.4.2.9 PERFORMANCE-BASED LONGITUDINAL SEPARATION MINIMA

Note.— Guidance material for implementation and application of the separation minima in this section is contained in the Performance-based Communication and Surveillance (PBCS) Manual (Doc 9869), the Global Operational Data Link (GOLD) Manual (Doc 10037), the Satellite Voice Operations Manual (SVOM) (Doc 10038) and the Guidelines for the Implementation of Performance-based Longitudinal Separation Minima (Circular 343).

5.4.2.9.1 Within designated airspace, or on designated routes, separation minima in accordance with the provisions of this section may be used.

5.4.2.9.2 The following separation minima may be used for aircraft cruising, climbing or descending on:

- a) the same track; or
- b) crossing tracks provided that the relative angle between the tracks is less than 90 degrees.

<i>Separation minima</i>	<i>RNP</i>	<i>RCP</i>	<i>RSP</i>	<i>Maximum ADS-C periodic reporting interval</i>
93 km (50 NM)	10	240	180	27 minutes
	4	240	180	32 minutes
55.5 km (30 NM)	2 or 4	240	180	12 minutes
5 minutes	2 or 4 or 10	240	180	14 minutes

Note.— Detailed information on the analysis used to determine these separation minima and monitoring procedures is contained in the Guidelines for the Implementation of Performance-based Longitudinal Separation Minima (Circular 343).

5.4.2.9.3 Opposite-direction aircraft on reciprocal tracks may be cleared to climb or descend to or through the levels occupied by another aircraft provided that ADS-C reports show that the aircraft have passed each other by the applicable separation minimum in 5.4.2.9.2.

5.4.2.9.4 The five-minute separation shall be calculated to a resolution of one second without rounding.

5.4.2.9.5 Separation shall be applied so that the distance or time between the calculated positions of the aircraft is never less than the prescribed minimum. This distance or time shall be obtained by one of the following methods:

- a) when the aircraft are on the same identical track, the distance or time may be measured between the calculated positions of the aircraft or may be calculated by measuring the distances or times to a common point on the track (see Figures 5-30 and 5-31);

Note.— Same identical tracks are a special case of same track defined in 5.4.2.1.5 a) where the angular difference is zero degrees or reciprocal tracks defined in 5.4.2.1.5 b) where the angular difference is 180 degrees.

- b) when the aircraft are on the same or reciprocal non-parallel tracks other than in a) above, or on crossing tracks, the distance or time shall be calculated by measuring the distances or times to the common point of intersection of the tracks or projected track (see Figures 5-32 to 5-34); and
- c) when the aircraft are on parallel tracks whose protection areas overlap, the distance or time shall be measured along the track of one of the aircraft, as in a) above, using its calculated position and the point abeam the calculated position of the other aircraft (see Figure 5-35).

Note.— In all cases presented in Figures 5-30 to 5-35, “d” and “t” are calculated by subtracting the distance or time of the closer aircraft from the common point from the distance or time of the more distant aircraft from the common point, except in Figure 5-34 where the two distances or times are added and the order of the aircraft is not important in the calculation.

5.4.2.9.6 The communication system provided to enable the application of the separation minima in 5.4.2.9.2 shall allow a controller, within 4 minutes, to intervene and resolve a potential conflict by contacting an aircraft using the normal means of communication. An alternative means shall be available to allow the controller to intervene and resolve the conflict within a total time of 10.5 minutes, should the normal means of communication fail.

5.4.2.9.7 When an ADS-C periodic or waypoint change event report is not received within 3 minutes of the time it should have been sent, the report is considered overdue and the controller shall take action to obtain the report as quickly as possible, normally by ADS-C or CPDLC. If a report is not received within 6 minutes of the time the original report should have been sent, and there is a possibility of loss of separation with other aircraft, the controller shall take action to resolve any potential conflict(s) as soon as possible. The communication means provided shall be such that the conflict is resolved within a further 7.5 minutes.

5.4.2.9.8 When information is received indicating ground or aircraft equipment failure or deterioration below the communication, navigation and surveillance performance requirements, ATC shall then, as required, apply alternative separation minima.

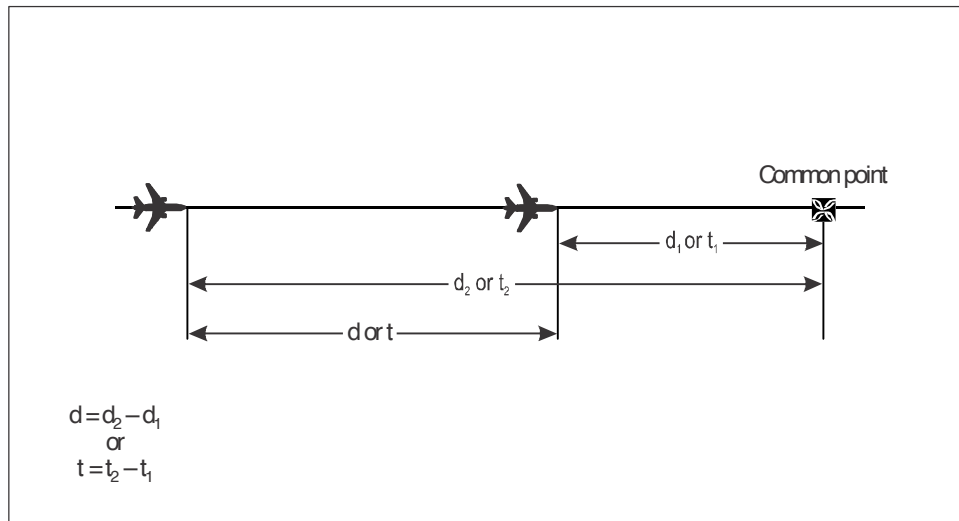

Figure 5-30. Calculation of longitudinal distance/time between aircraft — identical track, same direction (see 5.4.2.9.5 a))

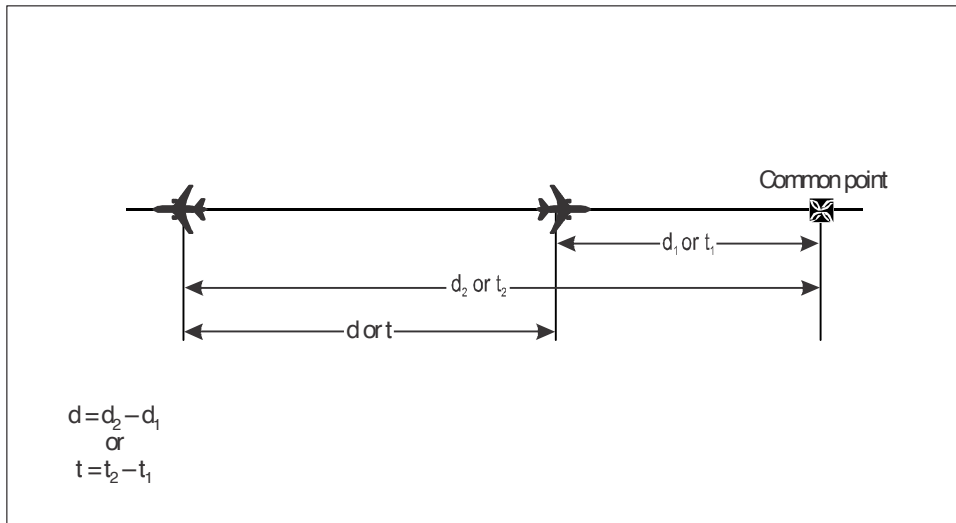

Figure 5-31. Calculation of longitudinal distance/time between aircraft — identical track, opposite direction (see 5.4.2.9.5 a))

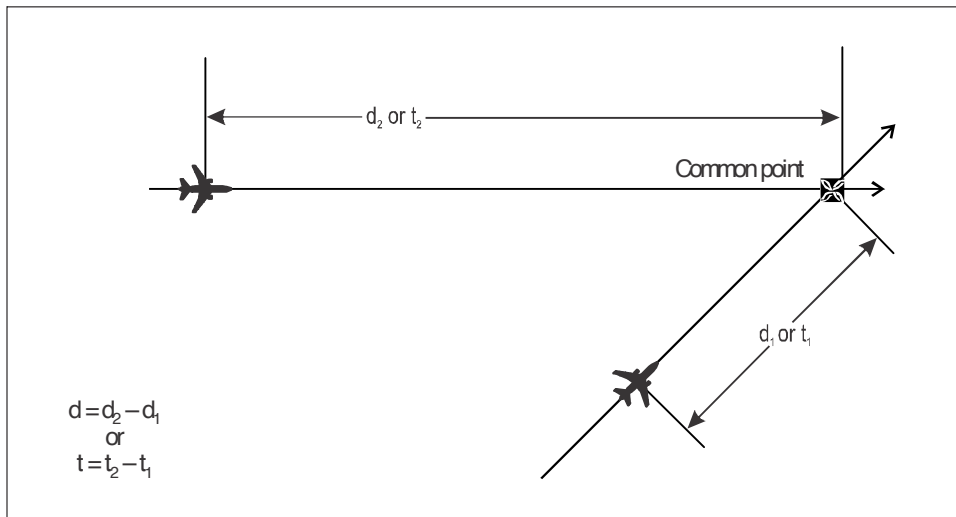

Figure 5-32. Calculation of longitudinal distance/time between aircraft — same track, but not identical (see 5.4.2.9.5 b))

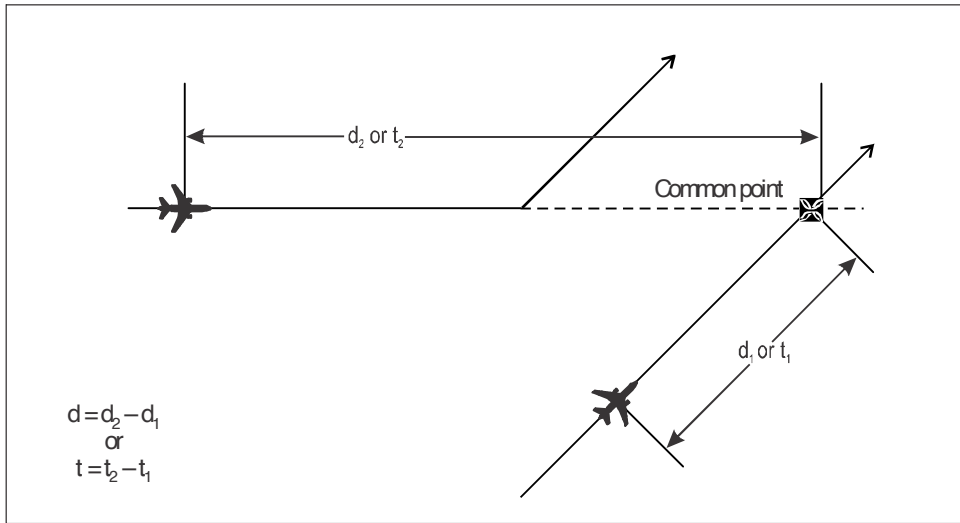

Figure 5-33. Calculation of longitudinal distance/time between aircraft — same track projected, but not identical (see 5.4.2.9.5 b))

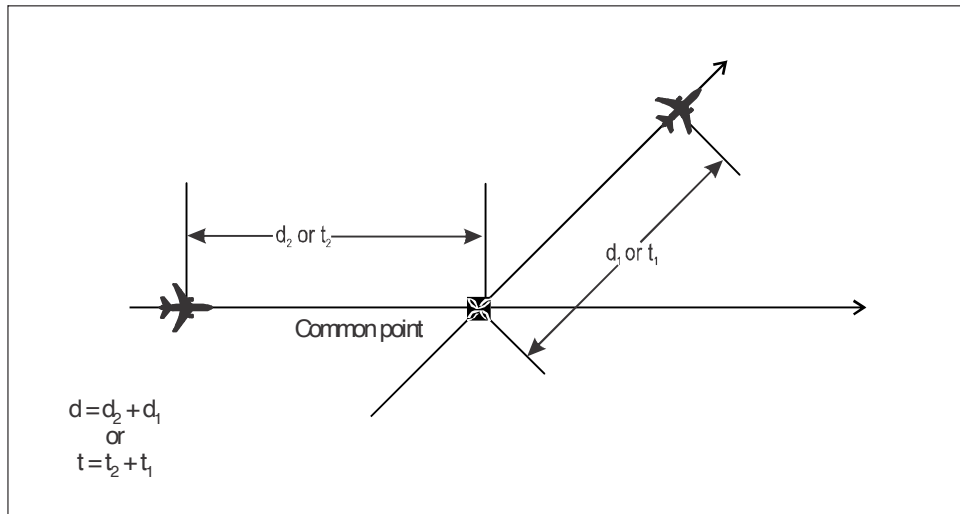

Figure 5-34. Calculation of longitudinal distance/time between aircraft — opposite sides of the common point (see 5.4.2.9.5 b))

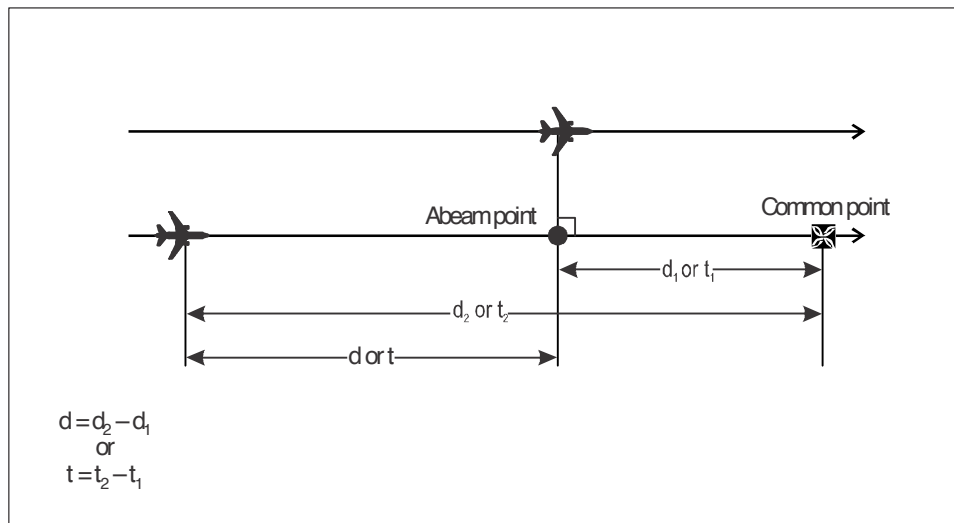

Figure 5-35. Calculation of longitudinal distance/time between aircraft — parallel tracks (see 5.4.2.9.5 c))

5.5 SEPARATION OF AIRCRAFT HOLDING IN FLIGHT

5.5.1 Aircraft established in adjacent holding patterns shall, except when lateral separation between the holding areas exists as determined by the appropriate ATS authority, be separated by the applicable vertical separation minimum.

5.5.2 Except when lateral separation exists, vertical separation shall be applied between aircraft holding in flight and other aircraft, whether arriving, departing or en route, whenever the other aircraft concerned are within five minutes flying time of the holding area or within a distance prescribed by the appropriate authority (see Figure 5-36).

5.6 MINIMUM SEPARATION BETWEEN DEPARTING AIRCRAFT

Note.— The following provisions are complementary to the longitudinal separation minima specified in Section 5.4.2.

5.6.1 One-minute separation is required if aircraft are to fly on tracks diverging by at least 45 degrees immediately after take-off so that lateral separation is provided (see Figure 5-37). This minimum may be reduced when aircraft are using parallel runways or when the procedure in Chapter 6, 6.3.3.1, is adopted for operations on diverging runways which do not cross, provided instructions covering the procedure have been approved by the appropriate ATS authority and lateral separation is effected immediately after take-off.

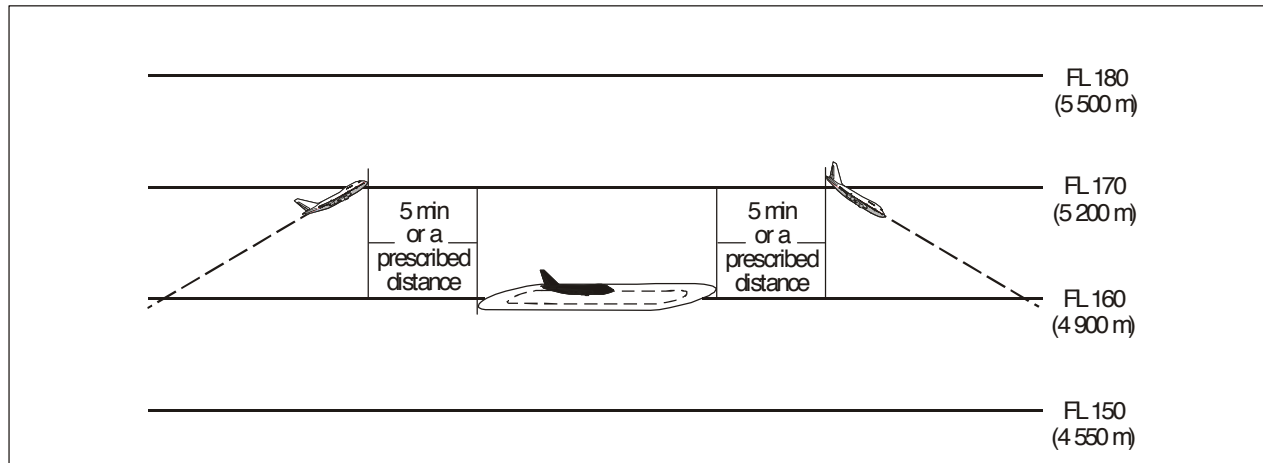

Figure 5-36. Separation between holding aircraft and en-route aircraft (see 5.5.2)

Note 1.— Wake turbulence categories of aircraft are contained in Chapter 4, Section 4.9.1 and longitudinal separation minima are contained in Section 5.8 and in Chapter 8, Section 8.7.

Note 2.— Detailed characteristics of wake vortices and their effect on aircraft are contained in the Air Traffic Services Planning Manual (Doc 9426), Part II, Section 5.

5.6.2 Two minutes are required between take-offs when the preceding aircraft is 74 km/h (40 kt) or more faster than the following aircraft and both aircraft will follow the same track (see Figure 5-38).

Note.— See Chapter 4, Section 4.6, concerning speed control instructions. Calculations, based on TAS, of speed differentials of aircraft during climb may not be sufficiently accurate in all circumstances for determining if the procedure in 5.6.2 can be applied, in which case calculations based on IAS may be more suitable.

5.6.3 Five-minute separation is required while vertical separation does not exist if a departing aircraft will be flown through the level of a preceding departing aircraft and both aircraft propose to follow the same track (see Figure 5-39). Action must be taken to ensure that the five-minute separation will be maintained or increased while vertical separation does not exist.

5.7 SEPARATION OF DEPARTING AIRCRAFT FROM ARRIVING AIRCRAFT

5.7.1 Except as otherwise prescribed by the appropriate ATS authority, the following separation shall be applied when take-off clearance is based on the position of an arriving aircraft.

5.7.1.1 If an arriving aircraft is making a complete instrument approach, a departing aircraft may take off:

- a) in any direction until an arriving aircraft has started its procedure turn or base turn leading to final approach;
- b) in a direction which is different by at least 45 degrees from the reciprocal of the direction of approach after the arriving aircraft has started procedure turn or base turn leading to final approach, provided that the take-off will be made at least 3 minutes before the arriving aircraft is estimated to be over the beginning of the instrument runway (see Figure 5-40).

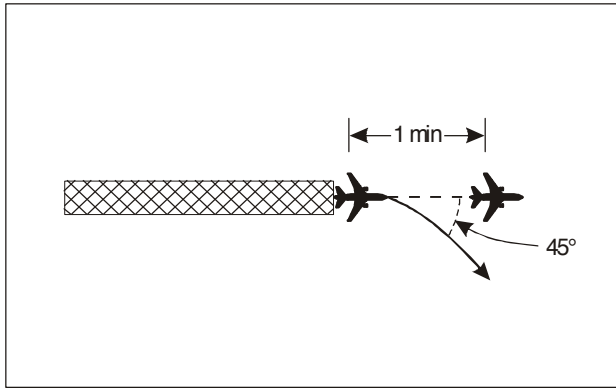

Figure 5-37. One-minute separation between departing aircraft following tracks diverging by at least 45 degrees (see 5.6.1)

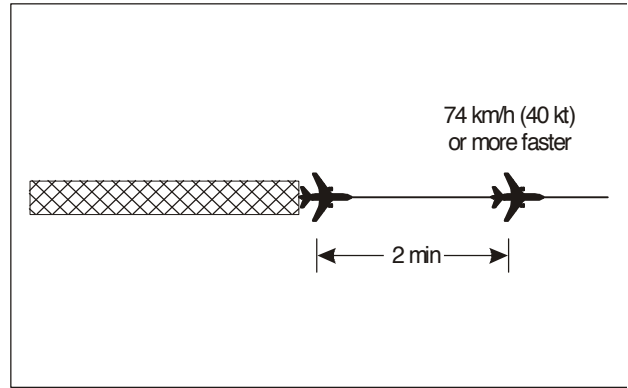

Figure 5-38. Two-minute separation between aircraft following same track (see 5.6.2)

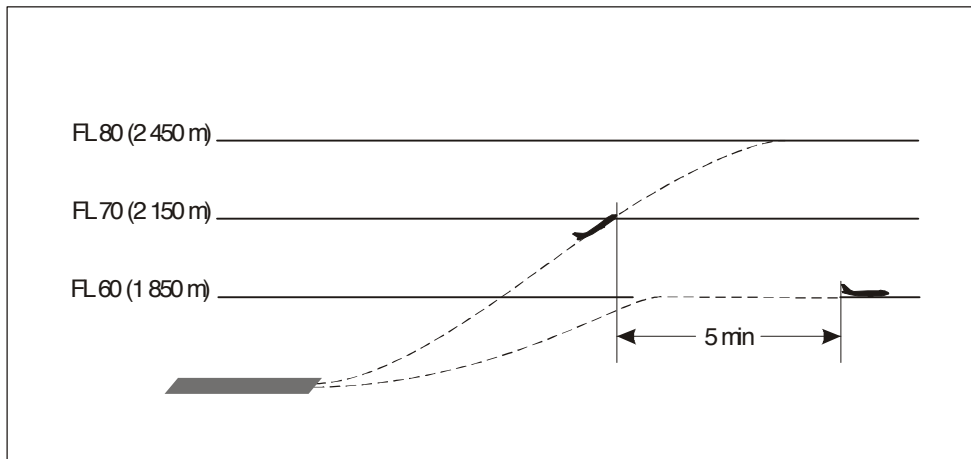

Figure 5-39. Five-minute separation of departing aircraft following same track (see 5.6.3)

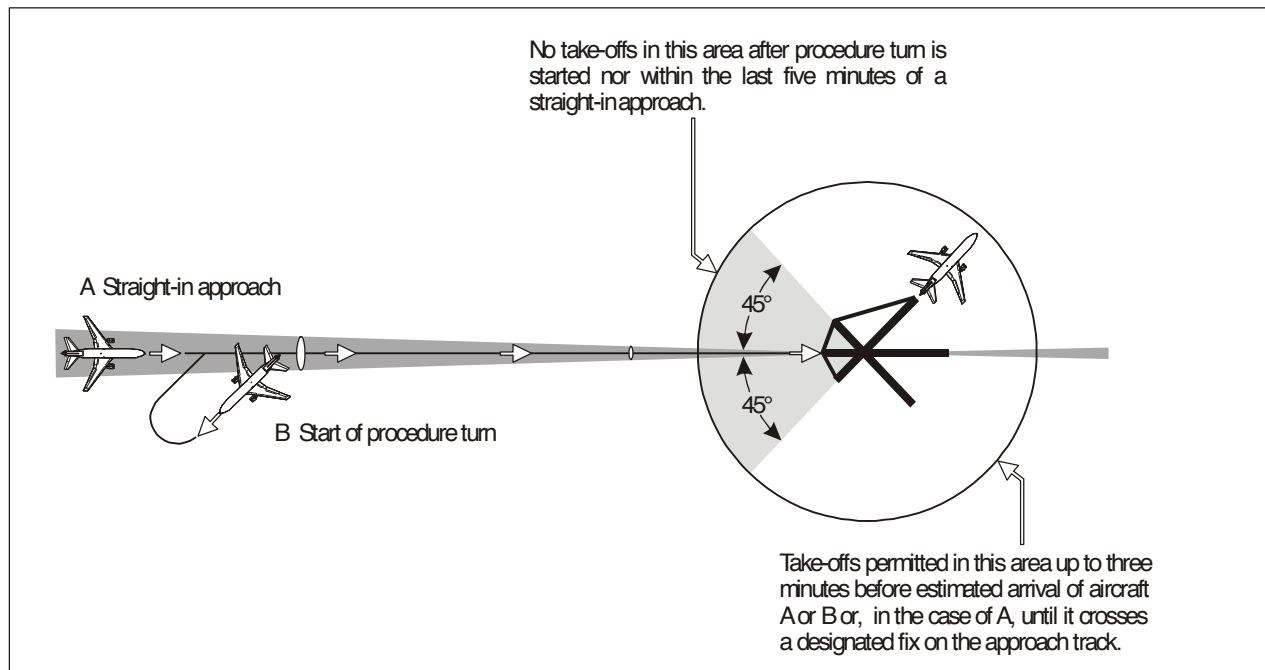

Figure 5-40. Separation of departing aircraft from arriving aircraft
(see 5.7.1.1 b) and 5.7.1.2 b))

5.7.1.2 If an arriving aircraft is making a straight-in approach, a departing aircraft may take off:

- a) in any direction until 5 minutes before the arriving aircraft is estimated to be over the instrument runway;
- b) in a direction which is different by at least 45 degrees from the reciprocal of the direction of approach of the arriving aircraft:
 - 1) until 3 minutes before the arriving aircraft is estimated to be over the beginning of the instrument runway (see Figure 5-40); or
 - 2) before the arriving aircraft crosses a designated fix on the approach track; the location of such fix to be determined by the appropriate ATS authority after consultation with the operators.

5.7.1.3 If an arriving aircraft is following an RNAV or RNP instrument flight procedure, a departing aircraft may take off on a departure path that is clear of the arrival protection area for the arriving aircraft (see Figure 5-41) provided:

- a) vertical separation is applied until the arriving aircraft has reported passing the compulsory reporting waypoint on the instrument flight procedure, the location of such waypoint to be determined by the appropriate ATS authority;
- b) the take-off takes place before the arriving aircraft crosses a designated waypoint on the instrument flight procedure, the location of such waypoint to be determined by the appropriate ATS authority; and
- c) the departing aircraft remains clear of the arrival protection area until another form of separation is established.

Note.— The arrival protection area is defined as the shaded area extending from a line 45 degrees from an established compulsory reporting waypoint to a line 45 degrees from the outermost edge of the remainder of the arrival and/or approach procedure (see Figure 5-41).

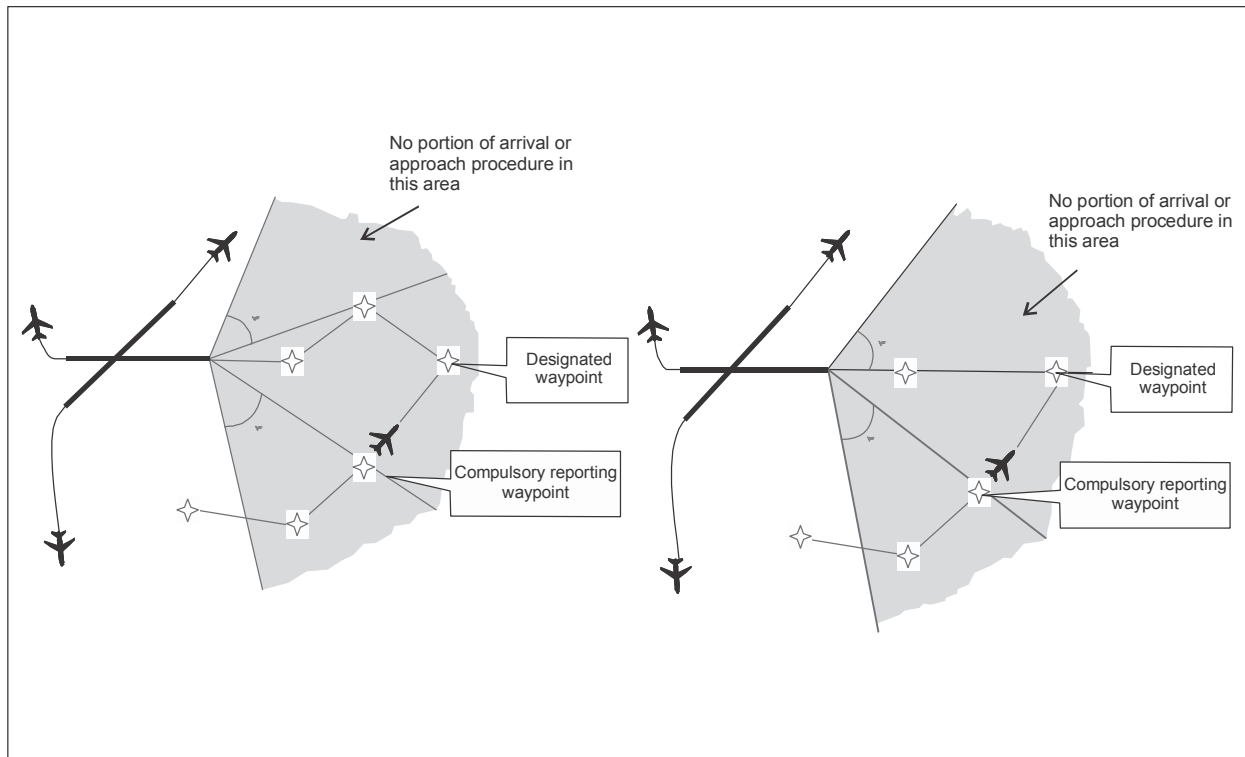

Figure 5-41. Examples of arrival protection area

5.8 TIME-BASED WAKE TURBULENCE LONGITUDINAL SEPARATION MINIMA

Note.— Distance-based wake turbulence separation minima are set forth in Chapter 8, 8.7.3.4.

5.8.1 Applicability

5.8.1.1 The ATC unit concerned shall not be required to apply wake turbulence separation:

- a) for arriving VFR flights landing on the same runway as a preceding landing HEAVY or MEDIUM aircraft; and
- b) between arriving IFR flights executing visual approach when the aircraft has reported the preceding aircraft in sight and has been instructed to follow and maintain own separation from that aircraft.

5.8.1.2 The ATC unit shall, in respect of the flights specified in 5.8.1.1 a) and b), as well as when otherwise deemed necessary, issue a caution of possible wake turbulence. The pilot-in-command of the aircraft concerned shall be responsible for ensuring that the spacing from a preceding aircraft of a heavier wake turbulence category is acceptable. If it is determined that additional spacing is required, the flight crew shall inform the ATC unit accordingly, stating their requirements.

5.8.2 Arriving aircraft

5.8.2.1 Except as provided for in 5.8.1.1 a) and b), the following separation minima shall be applied.

5.8.2.1.1 The following minima shall be applied to aircraft landing behind a HEAVY or a MEDIUM aircraft:

- a) MEDIUM aircraft behind HEAVY aircraft — 2 minutes;
- b) LIGHT aircraft behind a HEAVY or MEDIUM aircraft — 3 minutes.

5.8.3 Departing aircraft

5.8.3.1 A minimum separation of 2 minutes shall be applied between a LIGHT or MEDIUM aircraft taking off behind a HEAVY aircraft or a LIGHT aircraft taking off behind a MEDIUM aircraft when the aircraft are using:

- a) the same runway;
- b) parallel runways separated by less than 760 m (2 500 ft);
- c) crossing runways if the projected flight path of the second aircraft will cross the projected flight path of the first aircraft at the same altitude or less than 300 m (1 000 ft) below;
- d) parallel runways separated by 760 m (2 500 ft) or more, if the projected flight path of the second aircraft will cross the projected flight path of the first aircraft at the same altitude or less than 300 m (1 000 ft) below.

Note.— See Figures 5-42 and 5-43.

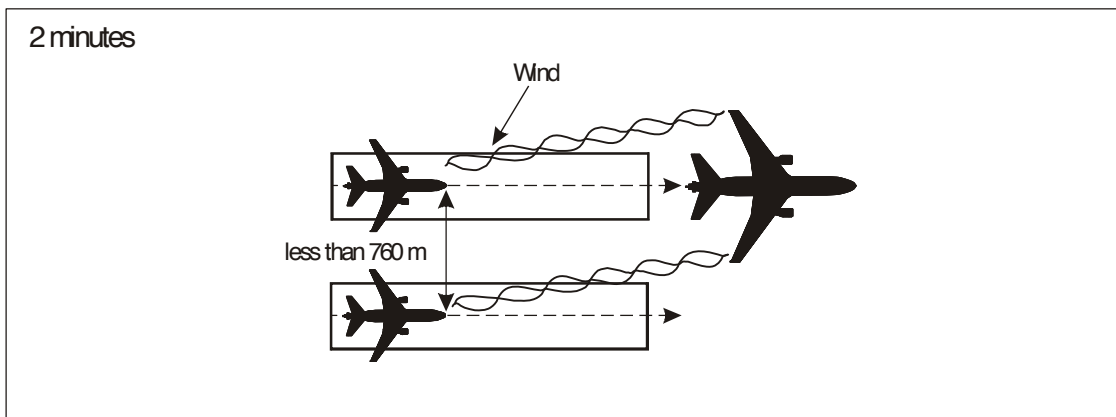

Figure 5-42. Two-minute separation for following aircraft
(see 5.8.3.1 a) and b))

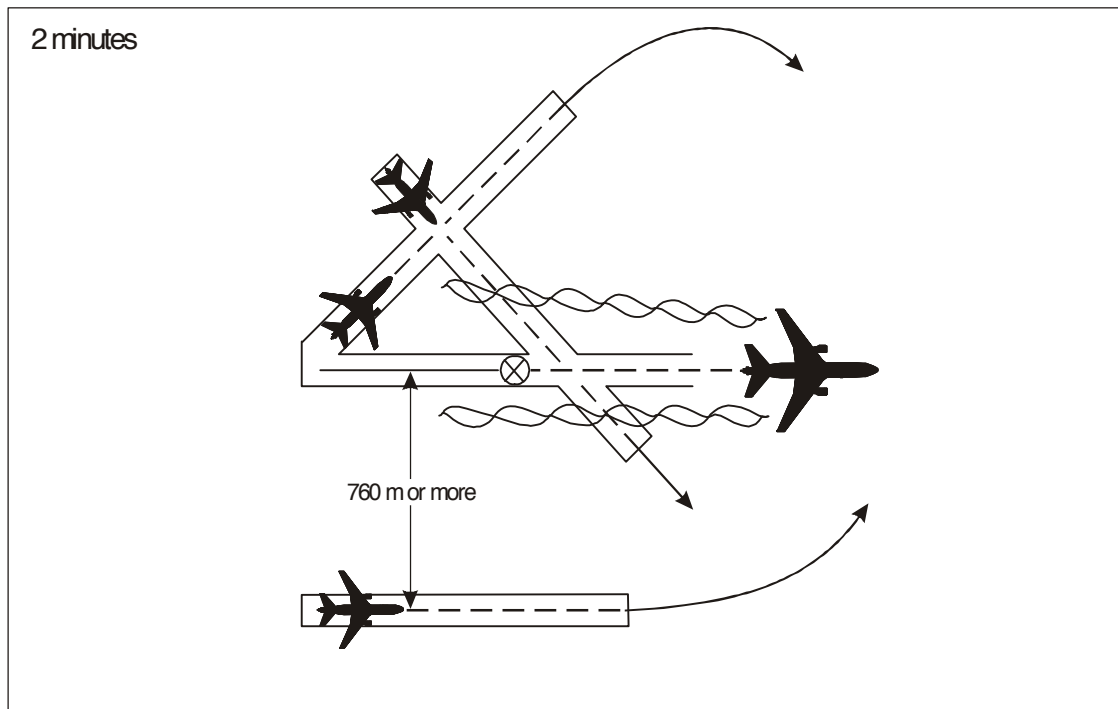

Figure 5-43. Two-minute wake turbulence separation for crossing aircraft (see 5.8.3.1 c) and d))

5.8.3.2 A separation minimum of 3 minutes shall be applied between a LIGHT or MEDIUM aircraft when taking off behind a HEAVY aircraft or a LIGHT aircraft when taking off behind a MEDIUM aircraft from:

- a) an intermediate part of the same runway; or
- b) an intermediate part of a parallel runway separated by less than 760 m (2 500 ft).

Note.— See Figure 5-44.

5.8.4 Displaced landing threshold

A separation minimum of 2 minutes shall be applied between a LIGHT or MEDIUM aircraft and a HEAVY aircraft and between a LIGHT aircraft and a MEDIUM aircraft when operating on a runway with a displaced landing threshold when:

- a) a departing LIGHT or MEDIUM aircraft follows a HEAVY aircraft arrival and a departing LIGHT aircraft follows a MEDIUM aircraft arrival; or
- b) an arriving LIGHT or MEDIUM aircraft follows a HEAVY aircraft departure and an arriving LIGHT aircraft follows a MEDIUM aircraft departure if the projected flight paths are expected to cross.

5.8.5 Opposite direction

A separation minimum of 2 minutes shall be applied between a LIGHT or MEDIUM aircraft and a HEAVY aircraft and between a LIGHT aircraft and a MEDIUM aircraft when the heavier aircraft is making a low or missed approach and the lighter aircraft is:

- a) utilizing an opposite-direction runway for take-off; or

Note.— See Figure 5-45.

- b) landing on the same runway in the opposite direction, or on a parallel opposite-direction runway separated by less than 760 m (2 500 ft).

Note.— See Figure 5-46.

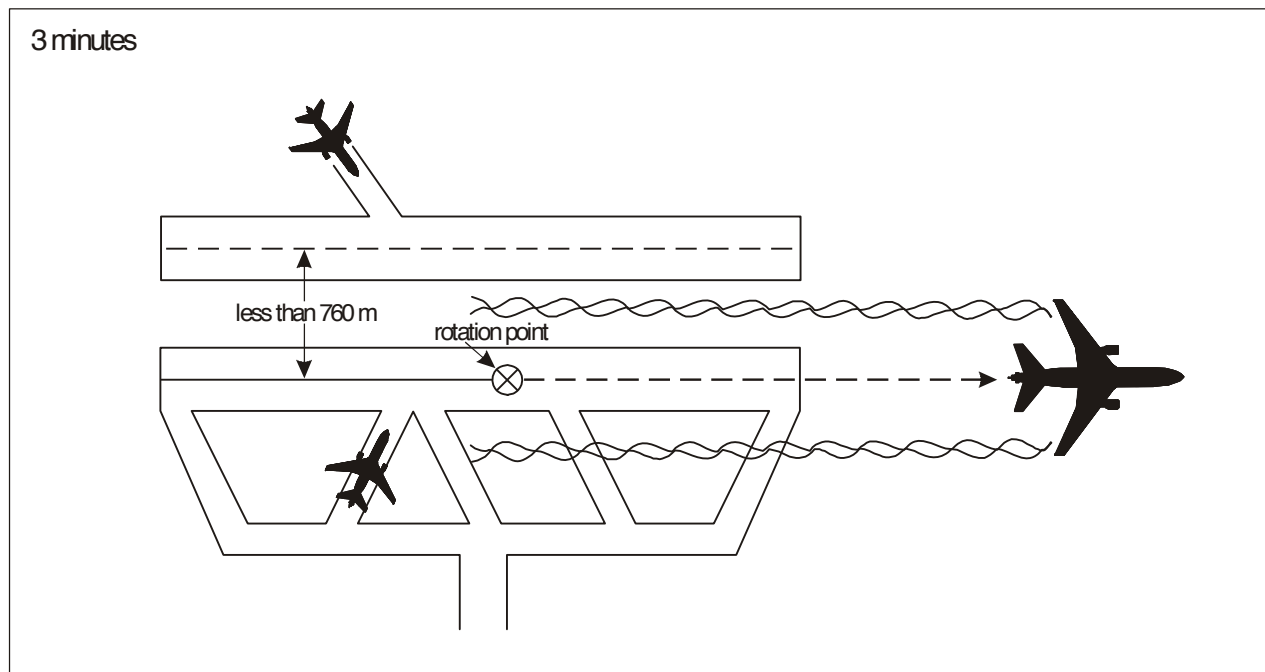

Figure 5-44. Three-minute wake turbulence separation for following aircraft (see 5.8.3.2)

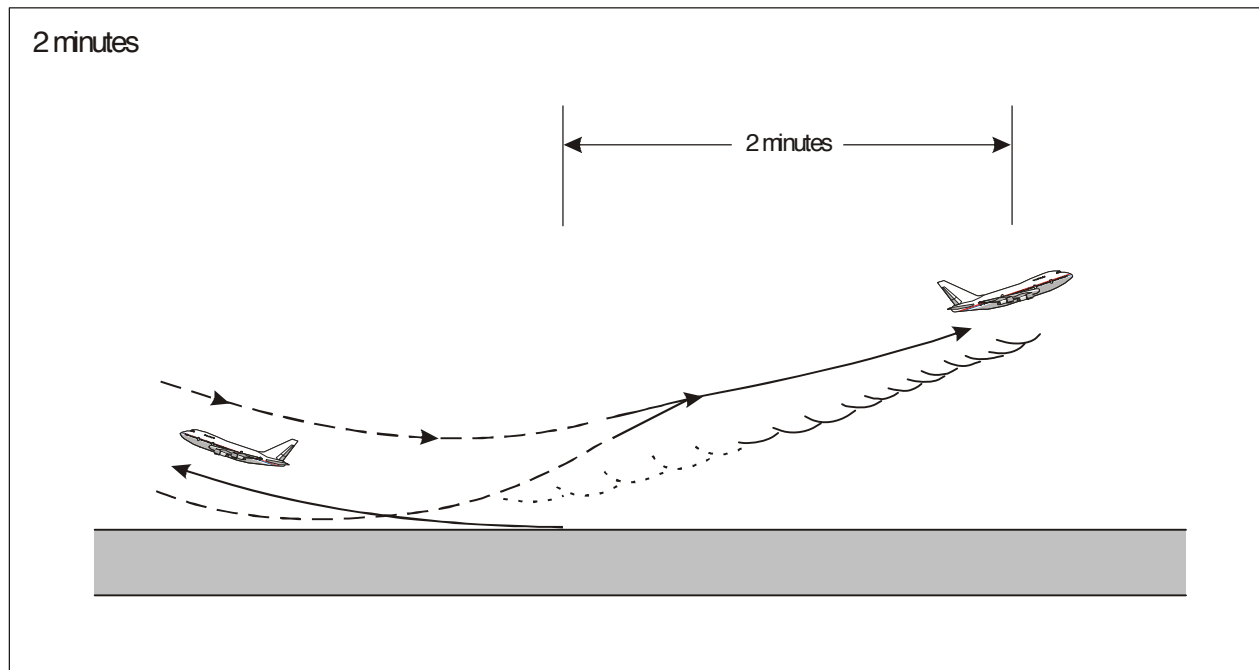

Figure 5-45. Two-minute wake turbulence separation for opposite-direction take-off (see 5.8.5 a))

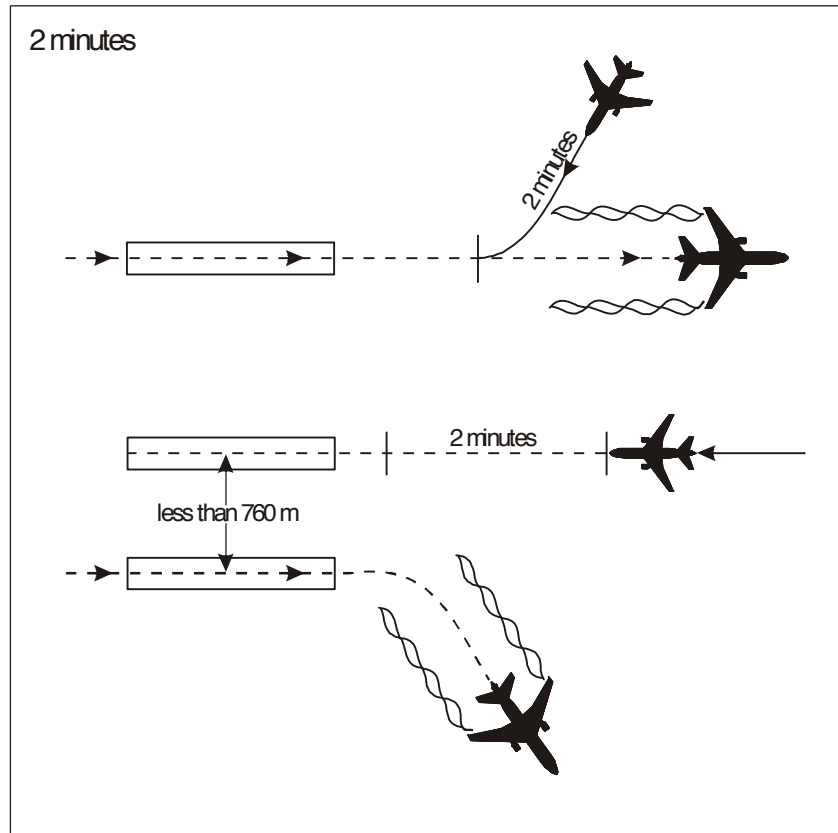

Figure 5-46. Two-minute wake turbulence separation for opposite-direction landing (see 5.8.5 b))

5.9 CLEARANCES TO FLY MAINTAINING OWN SEPARATION WHILE IN VISUAL METEOROLOGICAL CONDITIONS

Note 1.— As indicated in this Section, the provision of vertical or horizontal separation by an air traffic control unit is not applicable in respect of any specified portion of a flight cleared subject to maintaining own separation and remaining in visual meteorological conditions. It is for the flight so cleared to ensure, for the duration of the clearance, that it is not operated in such proximity to other flights as to create a collision hazard.

Note 2.— It is axiomatic that a VFR flight must remain in visual meteorological conditions at all times. Accordingly, the issuance of a clearance to a VFR flight to fly subject to maintaining own separation and remaining in visual meteorological conditions has no other object than to signify that, for the duration of the clearance, separation from other aircraft by air traffic control is not provided.

Note 3.— The objectives of the air traffic control service as prescribed in Annex 11 do not include prevention of collision with terrain. The procedures prescribed in this document do not relieve pilots of their responsibility to ensure that any clearances issued by air traffic control units are safe in this respect. When an IFR flight is vectored or is given a direct routing which takes the aircraft off an ATS route, the procedures in Chapter 8, 8.6.5.2 apply.

When so requested by an aircraft and provided it is agreed by the pilot of the other aircraft and so authorized by the appropriate ATS authority, an ATC unit may clear a controlled flight, including departing and arriving flights, operating in airspace Classes D and E in visual meteorological conditions during the hours of daylight to fly subject to maintaining own separation to one other aircraft and remaining in visual meteorological conditions. When a controlled flight is so cleared, the following shall apply:

- a) the clearance shall be for a specified portion of the flight at or below 3 050 m (10 000 ft), during climb or descent and subject to further restrictions as and when prescribed on the basis of regional air navigation agreements;
- b) if there is a possibility that flight under visual meteorological conditions may become impracticable, an IFR flight shall be provided with alternative instructions to be complied with in the event that flight in visual meteorological conditions (VMC) cannot be maintained for the term of the clearance;
- c) the pilot of an IFR flight, on observing that conditions are deteriorating and considering that operation in VMC will become impossible, shall inform ATC before entering instrument meteorological conditions (IMC) and shall proceed in accordance with the alternative instructions given.

Note.— See also 5.10.1.2.

5.10 ESSENTIAL TRAFFIC INFORMATION

5.10.1 General

5.10.1.1 Essential traffic is that controlled traffic to which the provision of separation by ATC is applicable, but which, in relation to a particular controlled flight is not, or will not be, separated from other controlled traffic by the appropriate separation minimum.

Note.— Pursuant to Section 5.2, but subject to certain exceptions stated therein, ATC is required to provide separation between IFR flights in airspace Classes A to E, and between IFR and VFR flights in Classes B and C. ATC is not required to provide separation between VFR flights, except within airspace Class B. Therefore, IFR or VFR flights may constitute essential traffic to IFR traffic, and IFR flights may constitute essential traffic to VFR traffic. However, a VFR flight would not constitute essential traffic to other VFR flights except within Class B airspace.

5.10.1.2 Essential traffic information shall be given to controlled flights concerned whenever they constitute essential traffic to each other.

Note.— This information will inevitably relate to controlled flights cleared subject to maintaining own separation and remaining in visual meteorological conditions and also whenever the intended separation minimum has been infringed.

5.10.2 Information to be provided

Essential traffic information shall include:

- a) direction of flight of aircraft concerned;
- b) type and wake turbulence category (if relevant) of aircraft concerned;
- c) cruising level of aircraft concerned; and
 - 1) estimated time over the reporting point nearest to where the level will be crossed; or

- 2) relative bearing of the aircraft concerned in terms of the 12-hour clock as well as distance from the conflicting traffic; or
- 3) actual or estimated position of the aircraft concerned.

Note 1. — Nothing in Section 5.10 is intended to prevent ATC from imparting to aircraft under its control any other information at its disposal with a view to enhancing air safety in accordance with the objectives of ATS as defined in Chapter 2 of Annex 11.

Note 2.— Wake turbulence category will only be essential traffic information if the aircraft concerned is of a heavier wake turbulence category than the aircraft to which the traffic information is directed.

5.11 REDUCTION IN SEPARATION MINIMA

Note.— See also Chapter 2, ATS Safety Management.

5.11.1 Provided an appropriate safety assessment has shown that an acceptable level of safety will be maintained, and after prior consultation with users, the separation minima detailed in 5.4.1 and 5.4.2 may be reduced in the following circumstances:

5.11.1.1 As determined by the appropriate ATS authority as appropriate:

- a) when special electronic or other aids enable the pilot-in-command of an aircraft to determine accurately the aircraft's position and when adequate communication facilities exist for that position to be transmitted without delay to the appropriate air traffic control unit; or
- b) when, in association with rapid and reliable communication facilities, information of an aircraft's position, derived from an ATS surveillance system, is available to the appropriate air traffic control unit; or
- c) when special electronic or other aids enable the air traffic controller to predict rapidly and accurately the flight paths of aircraft, and adequate facilities exist to verify frequently the actual aircraft positions with the predicted positions; or
- d) when RNAV-equipped aircraft operate within the coverage of electronic aids that provide the necessary updates to maintain navigation accuracy.

5.11.1.2 In accordance with regional air navigation agreements when:

- a) special electronic, area navigation or other aids enable the aircraft to closely adhere to their current flight plans; and
- b) the air traffic situation is such that the conditions in 5.11.1.1 a) regarding communications between pilots and the appropriate ATC unit or units need not necessarily be met to the degree specified therein.

Note.— Attention is drawn to the guidance material contained in the Air Traffic Services Planning Manual (Doc 9426) regarding conditions governing the reduction of separation minima and to the Manual on Airspace Planning Methodology for the Determination of Separation Minima (Doc 9689).

Chapter 6

SEPARATION IN THE VICINITY OF AERODROMES

6.1 REDUCTION IN SEPARATION MINIMA IN THE VICINITY OF AERODROMES

In addition to the circumstances mentioned in Chapter 5, 5.11.1, the separation minima detailed in Chapter 5, 5.4.1 and 5.4.2, may be reduced in the vicinity of aerodromes if:

- a) adequate separation can be provided by the aerodrome controller when each aircraft is continuously visible to this controller; or
- b) each aircraft is continuously visible to flight crews of the other aircraft concerned and the pilots thereof report that they can maintain their own separation; or
- c) in the case of one aircraft following another, the flight crew of the succeeding aircraft reports that the other aircraft is in sight and separation can be maintained.

6.2 ESSENTIAL LOCAL TRAFFIC

6.2.1 Information on essential local traffic known to the controller shall be transmitted without delay to departing and arriving aircraft concerned.

Note 1.— Essential local traffic in this context consists of any aircraft, vehicle or personnel on or near the runway to be used, or traffic in the take-off and climb-out area or the final approach area, which may constitute a collision hazard to a departing or arriving aircraft.

Note 2.— See also Chapter 5, Section 5.10, Chapter 7, 7.4.1.3 and Chapter 8, 8.8.2.

6.2.1.1 Essential local traffic shall be described so as to be easily identified.

6.3 PROCEDURES FOR DEPARTING AIRCRAFT

6.3.1 General

6.3.1.1 Clearances for departing aircraft shall specify, when necessary for the separation of aircraft, direction of take-off and turn after take-off; heading or track to be made good before taking up the cleared departure track; level to maintain before continuing climb to assigned level; time, point and/or rate at which a level change shall be made; and any other necessary manoeuvre consistent with safe operation of the aircraft.

6.3.1.2 At aerodromes where standard instrument departures (SIDs) have been established, departing aircraft should normally be cleared to follow the appropriate SID.

6.3.2 Standard clearances for departing aircraft

6.3.2.1 GENERAL

The appropriate ATS authority should, wherever possible, establish standardized procedures for transfer of control between the ATC units concerned, and standard clearances for departing aircraft.

Note.— The provisions applying to standardized procedures for coordination and transfer of control are specified in Chapter 10, Section 10.1.1.

6.3.2.2 COORDINATION

6.3.2.2.1 Where standard clearances for departing aircraft have been agreed to between the units concerned, the aerodrome control tower will normally issue the appropriate standard clearance without prior coordination with or approval from the approach control unit or ACC.

6.3.2.2.2 Prior coordination of clearances should be required only in the event that a variation to the standard clearance or the standardized transfer of control procedures is necessary or desirable for operational reasons.

6.3.2.2.3 Provision shall be made to ensure that the approach control unit at all times is kept informed of the sequence in which aircraft will depart as well as the runway to be used.

6.3.2.2.4 Provision shall be made to display the designators of assigned SIDs to the aerodrome control tower, the approach control unit and/or the ACC as applicable.

6.3.2.3 CONTENTS

Standard clearances for departing aircraft shall contain the following items:

- a) aircraft identification;
- b) clearance limit, normally destination aerodrome;
- c) designator of the assigned SID, if applicable;
- d) cleared level;
- e) allocated SSR code;
- f) any other necessary instructions or information not contained in the SID description, e.g. instructions relating to change of frequency.

Note 1.— See 6.3.2.4.1 for clearances to aircraft on SID.

Note 2.— The use of a SID designator without a cleared level does not authorize the aircraft to climb on the SID vertical profile.

6.3.2.4 CLEARANCES ON A SID

6.3.2.4.1 Clearances to aircraft on a SID with remaining published level and/or speed restrictions shall indicate if such restrictions are to be followed or are cancelled. The following phraseologies shall be used with the following meanings:

- a) CLIMB VIA SID TO (*level*):
 - i) climb to the cleared level and comply with published level restrictions;
 - ii) follow the lateral profile of the SID; and
 - iii) comply with published speed restrictions or ATC-issued speed control instructions as applicable.
- b) CLIMB VIA SID TO (*level*), CANCEL LEVEL RESTRICTION(S):
 - i) climb to the cleared level; published level restrictions are cancelled;
 - ii) follow the lateral profile of the SID; and
 - iii) comply with published speed restrictions or ATC-issued speed control instructions as applicable.
- c) CLIMB VIA SID TO (*level*), CANCEL LEVEL RESTRICTION(S) AT (*point(s)*):
 - i) climb to the cleared level; published level restriction(s) at the specified point(s) are cancelled;
 - ii) follow the lateral profile of the SID; and
 - iii) comply with published speed restrictions or ATC-issued speed control instructions as applicable.
- d) CLIMB VIA SID TO (*level*), CANCEL SPEED RESTRICTION(S):
 - i) climb to the cleared level and comply with published level restrictions;
 - ii) follow the lateral profile of the SID; and
 - iii) published speed restrictions and ATC-issued speed control instructions are cancelled.
- e) CLIMB VIA SID TO (*level*), CANCEL SPEED RESTRICTION(S) AT (*point(s)*):
 - i) climb to the cleared level and comply with published level restrictions;
 - ii) follow the lateral profile of the SID; and
 - iii) published speed restrictions are cancelled at the specified point(s).
- f) CLIMB UNRESTRICTED TO (*level*) or CLIMB TO (*level*), CANCEL LEVEL AND SPEED RESTRICTION(S):
 - i) climb to the cleared level; published level restrictions are cancelled;
 - ii) follow the lateral profile of the SID; and
 - iii) published speed restrictions and ATC-issued speed control instructions are cancelled.

6.3.2.4.2 If there are no remaining published level or speed restrictions on the SID, the phrase CLIMB TO (*level*) should be used.

6.3.2.4.3 When subsequent speed restriction instructions are issued, and if the cleared level is unchanged, the phrase CLIMB VIA SID TO (*level*) should be omitted.

6.3.2.4.4 When a departing aircraft is cleared to proceed direct to a published waypoint on the SID, the speed and level restrictions associated with the bypassed waypoints are cancelled. All remaining published speed and level restrictions shall remain applicable.

6.3.2.4.5 When a departing aircraft is vectored or cleared to proceed to a point that is not on the SID, all the published speed and level restrictions of the SID are cancelled and the controller shall:

- a) reiterate the cleared level;
- b) provide speed and level restrictions as necessary; and
- c) notify the pilot if it is expected that the aircraft will be instructed to subsequently rejoin the SID.

Note.— See also 8.6.5.2 regarding prescribed obstacle clearance.

6.3.2.4.6 ATC instructions to an aircraft to rejoin a SID shall include:

- a) the designator of the SID to be rejoin, unless advance notification of rejoin has been provided in accordance with 6.3.2.4.5;
- b) the cleared level in accordance with 6.3.2.4.1; and
- c) the position at which it is expected to rejoin the SID.

Note.— See 12.3.3.1 for phraseology on rejoin instructions.

6.3.2.5 COMMUNICATION FAILURE

6.3.2.5.1 Clearances for departing aircraft may specify a cleared level other than that indicated in the filed flight plan for the en-route phase of flight, without a time or geographical limit for the cleared level. Such clearances will normally be used to facilitate the application of tactical control methods by ATC, normally through the use of an ATS surveillance system.

6.3.2.5.2 Where clearances for departing aircraft contain no time or geographical limit for a cleared level, action to be taken by an aircraft experiencing air-ground communication failure in the event the aircraft has been radar vectored away from the route specified in its current flight plan should be prescribed on the basis of a regional air navigation agreement and included in the SID description or published in AIPs.

6.3.3 Departure sequence

6.3.3.1 Departing aircraft may be expedited by suggesting a take-off direction which is not into the wind. It is the responsibility of the pilot-in-command of an aircraft to decide between making such a take-off or waiting for take-off in a preferred direction.

6.3.3.2 If departures are delayed, the delayed flights shall normally be cleared in an order based on their estimated time of departure, except that deviation from this order may be made to:

- a) facilitate the maximum number of departures with the least average delay;
- b) accommodate requests by an operator in respect of that operator's flights to the extent practicable.

6.3.3.3 Air traffic control units should, when practicable, advise aircraft operators or their designated representatives when anticipated delays are expected to exceed 30 minutes.

6.4 INFORMATION FOR DEPARTING AIRCRAFT

Note.— See Chapter 11, 11.4.3, regarding flight information messages.

6.4.1 Meteorological conditions

Information regarding significant changes in the meteorological conditions in the take-off or climb-out area, obtained by the unit providing approach control service after a departing aircraft has established communication with such unit, shall be transmitted to the aircraft without delay, except when it is known that the aircraft already has received the information.

Note.— Significant changes in this context include those relating to surface wind direction or speed, visibility, runway visual range or air temperature (for turbine-engined aircraft), and the occurrence of thunderstorm or cumulonimbus, moderate or severe turbulence, wind shear, hail, moderate or severe icing, severe squall line, freezing precipitation, severe mountain waves, sandstorm, duststorm, blowing snow, tornado or waterspout.

6.4.2 Operational status of visual or non-visual aids

Information regarding changes in the operational status of visual or non-visual aids essential for take-off and climb shall be transmitted without delay to a departing aircraft, except when it is known that the aircraft already has received the information.

6.5 PROCEDURES FOR ARRIVING AIRCRAFT

6.5.1 General

6.5.1.1 When it becomes evident that delays will be encountered by arriving aircraft, operators or designated representatives shall, to the extent practicable, be notified and kept currently informed of any changes in such expected delays.

6.5.1.2 Arriving aircraft may be required to report when leaving or passing a significant point or navigation aid, or when starting procedure turn or base turn, or to provide other information required by the controller, to expedite departing and arriving aircraft.

6.5.1.3 An IFR flight shall not be cleared for an initial approach below the appropriate minimum altitude as specified by the State concerned nor to descend below that altitude unless:

- a) the pilot has reported passing an appropriate point defined by a navigation aid or as a waypoint; or
- b) the pilot reports that the aerodrome is and can be maintained in sight; or
- c) the aircraft is conducting a visual approach; or
- d) the controller has determined the aircraft's position by the use of an ATS surveillance system, and a lower minimum altitude has been specified for use when providing ATS surveillance services.

6.5.1.4 At aerodromes where standard instrument arrivals (STARs) have been established, arriving aircraft should normally be cleared to follow the appropriate STAR. The aircraft shall be informed of the type of approach to expect and runway-in-use as early as possible.

Note.— See Section 6.5.2 concerning Standard arrival clearances.

6.5.1.5 After coordination with the approach control unit, the ACC may clear the first arriving aircraft for approach rather than to a holding fix.

6.5.2 Standard clearances for arriving aircraft

6.5.2.1 GENERAL

The appropriate ATS authority should, wherever possible, establish standardized procedures for transfer of control between the ATC units concerned, and standard clearances for arriving aircraft.

Note.— The provisions applying to standardized procedures for coordination and transfer of control are specified in Chapter 10, Section 10.1.1.

6.5.2.2 COORDINATION

6.5.2.2.1 Where standard clearances for arriving aircraft are in use and, provided no terminal delay is expected, clearance to follow the appropriate STAR will normally be issued by the ACC without prior coordination with or approval from the approach control unit or the aerodrome control tower as applicable.

6.5.2.2.2 Prior coordination of clearances should be required only in the event that a variation to the standard clearance or the standardized transfer of control procedures is necessary or desirable for operational reasons.

6.5.2.2.3 Provision shall be made to ensure that the approach control unit is at all times kept informed of the sequence of aircraft following the same STAR.

6.5.2.2.4 Provision shall be made to display the designators of assigned STARs to the ACC, the approach control unit and/or the aerodrome control tower, as applicable.

6.5.2.3 CONTENTS

Standard clearances for arriving aircraft shall contain the following items:

- a) aircraft identification;
- b) designator of the assigned STAR if applicable;
- c) runway-in-use, except when part of the STAR description;
- d) cleared level; and
- e) any other necessary instructions or information not contained in the STAR description, e.g. change of communications.

Note 1.— See 6.5.2.4.1 for clearances on a STAR.

Note 2.— The use of a STAR designator without a cleared level does not authorize the aircraft to descend on the STAR vertical profile.

6.5.2.4 CLEARANCES ON A STAR

6.5.2.4.1 Clearances to aircraft on a STAR with remaining published level and/or speed restrictions shall indicate if such restrictions are to be followed or are cancelled. The following phraseologies shall be used with the following meaning:

- a) DESCEND VIA STAR TO (*level*):
 - i) descend to the cleared level and comply with published level restrictions;
 - ii) follow the lateral profile of the STAR; and
 - iii) comply with published speed restrictions or ATC-issued speed control instructions as applicable.
- b) DESCEND VIA STAR TO (*level*), CANCEL LEVEL RESTRICTION(S):
 - i) descend to the cleared level; published level restrictions are cancelled;
 - ii) follow the lateral profile of the STAR; and
 - iii) comply with published speed restrictions or ATC-issued speed control instructions as applicable.
- c) DESCEND VIA STAR TO (*level*), CANCEL LEVEL RESTRICTION(S) AT (*point(s)*):
 - i) descend to the cleared level; published level restriction(s) at the specified point(s) are cancelled;
 - ii) follow the lateral profile of the STAR; and
 - iii) comply with published speed restrictions or ATC-issued speed control instructions as applicable.
- d) DESCEND VIA STAR TO (*level*), CANCEL SPEED RESTRICTION(S):
 - i) descend to the cleared level and comply with published level restrictions;
 - ii) follow the lateral profile of the STAR; and
 - iii) published speed restrictions and ATC-issued speed control instructions are cancelled.
- e) DESCEND VIA STAR TO (*level*), CANCEL SPEED RESTRICTION(S) AT (*point(s)*):
 - i) descend to the cleared level and comply with published level restrictions;
 - ii) follow the lateral profile of the STAR; and
 - iii) published speed restrictions are cancelled at the specified point(s).
- f) DESCEND UNRESTRICTED TO (*level*) or DESCEND TO (*level*), CANCEL LEVEL AND SPEED RESTRICTION(S):
 - i) descend to the cleared level; published level restrictions are cancelled;
 - ii) follow the lateral profile of the STAR; and
 - iii) published speed restrictions and ATC-issued speed control instructions are cancelled.

6.5.2.4.2 If there are no remaining published level or speed restrictions on the STAR, the phrase DESCEND TO (*level*) should be used.

6.5.2.4.3 When subsequent speed restriction instructions are issued and if the cleared level is unchanged, the phrase DESCEND VIA STAR TO (*level*) should be omitted.

6.5.2.4.4 When an arriving aircraft is cleared to proceed direct to a published waypoint on the STAR, the speed and level restrictions associated with the bypassed waypoints are cancelled. All remaining published speed and level restrictions shall remain applicable.

6.5.2.4.5 When an arriving aircraft is vectored or cleared to proceed to a point that is not on the STAR, all the published speed and level restrictions of the STAR are cancelled and the controller shall:

- a) reiterate the cleared level;
- b) provide speed and level restrictions as necessary; and
- c) notify the pilot if it is expected that the aircraft will be instructed to subsequently rejoin the STAR.

Note.— See 8.6.5.2 regarding prescribed obstacle clearance.

6.5.2.4.6 ATC instructions to an aircraft to rejoin a STAR shall include:

- a) the designator of the STAR to be rejoined, unless advance notification of rejoin has been provided in accordance with 6.5.2.4.5;
- b) the cleared level on rejoining the STAR in accordance with 6.5.2.4.1; and
- c) the position at which it is expected to rejoin the STAR.

Note.— See 12.3.3.2 for phraseology on rejoin instructions.

6.5.3 Visual approach

6.5.3.1 Subject to the conditions in 6.5.3.3, clearance for an IFR flight to execute a visual approach may be requested by a flight crew or initiated by the controller. In the latter case, the concurrence of the flight crew shall be required.

6.5.3.2 Controllers shall exercise caution in initiating a visual approach when there is reason to believe that the flight crew concerned is not familiar with the aerodrome and its surrounding terrain. Controllers should also take into consideration the prevailing traffic and meteorological conditions when initiating visual approaches.

6.5.3.3 An IFR flight may be cleared to execute a visual approach provided the pilot can maintain visual reference to the terrain and:

- a) the reported ceiling is at or above the level of the beginning of the initial approach segment for the aircraft so cleared; or
- b) the pilot reports at the level of the beginning of the initial approach segment or at any time during the instrument approach procedure that the meteorological conditions are such that with reasonable assurance a visual approach and landing can be completed.

6.5.3.4 Separation shall be provided between an aircraft cleared to execute a visual approach and other arriving and departing aircraft.

6.5.3.5 For successive visual approaches, separation shall be maintained by the controller until the pilot of a succeeding aircraft reports having the preceding aircraft in sight. The aircraft shall then be instructed to follow and maintain own separation from the preceding aircraft. When both aircraft are of a heavy wake turbulence category, or the preceding aircraft is of a heavier wake turbulence category than the following, and the distance between the aircraft is less than the appropriate wake turbulence minimum, the controller shall issue a caution of possible wake turbulence. The pilot-in-command of the aircraft concerned shall be responsible for ensuring that the spacing from a preceding aircraft of a heavier wake turbulence category is acceptable. If it is determined that additional spacing is required, the flight crew shall inform the ATC unit accordingly, stating their requirements.

6.5.3.6 Transfer of communications to the aerodrome controller should be effected at such a point or time that information on essential local traffic, if applicable, and clearance to land or alternative instructions can be issued to the aircraft in a timely manner.

6.5.4 Instrument approach

6.5.4.1 The approach control unit shall specify the instrument approach procedure to be used by arriving aircraft. A flight crew may request an alternative procedure and, if circumstances permit, should be cleared accordingly.

6.5.4.2 If a pilot reports or it is clearly apparent to the ATC unit that the pilot is not familiar with an instrument approach procedure, the initial approach level, the point (in minutes from the appropriate reporting point) at which base turn or procedure turn will be started, the level at which the procedure turn shall be carried out and the final approach track shall be specified, except that only the last-mentioned need be specified if the aircraft is to be cleared for a straight-in approach. The frequency(ies) of the navigation aid(s) to be used as well as the missed approach procedure shall also be specified when deemed necessary.

6.5.4.3 If visual reference to terrain is established before completion of the approach procedure, the entire procedure must nevertheless be executed unless the aircraft requests and is cleared for a visual approach.

6.5.5 Holding

6.5.5.1 In the event of extended delays, aircraft should be advised of the anticipated delay as early as possible and, when practicable, be instructed or given the option to reduce speed en route in order to absorb delay.

6.5.5.2 When delay is expected, the ACC shall normally be responsible for clearing aircraft to the holding fix, and for including holding instructions, and expected approach time or onward clearance time, as applicable, in such clearances. (See Section 6.5.8.)

6.5.5.3 After coordination with the approach control unit, the ACC may clear an arriving aircraft to a visual holding location to hold until further advised by the approach control unit.

6.5.5.4 After coordination with the aerodrome control tower, the approach control unit may clear an arriving aircraft to a visual holding location to hold until further advised by the aerodrome control tower.

6.5.5.5 Holding and holding pattern entry shall be accomplished in accordance with procedures established by the appropriate ATS authority and published in AIPs. If entry and holding procedures have not been published or if the procedures are not known to a flight crew, the appropriate air traffic control unit shall specify the designator of the location or aid to be used, the inbound track, radial or bearing, direction of turn in the holding pattern as well as the time of the outbound leg or the distances between which to hold.

6.5.5.6 Aircraft should normally be held at a designated holding fix. The required minimum vertical, lateral or longitudinal separation from other aircraft shall be provided. Criteria and procedures for the simultaneous use of adjacent holding patterns shall be prescribed in local instructions.

Note.— See Chapter 5, Section 5.5, concerning separation of aircraft holding in flight.

6.5.5.7 Levels at a holding fix or visual holding location shall as far as practicable be assigned in a manner that will facilitate clearing each aircraft to approach in its proper priority. Normally, the first aircraft to arrive over a holding fix or visual holding location should be at the lowest level, with following aircraft at successively higher levels.

6.5.5.8 When extended holding is anticipated, turbojet aircraft should, when practicable, be permitted to hold at higher levels in order to conserve fuel, while retaining their order in the approach sequence.

6.5.5.9 If an aircraft is unable to comply with the published or cleared holding procedure, alternative instructions shall be issued.

6.5.5.10 For the purpose of maintaining a safe and orderly flow of traffic, an aircraft may be instructed to orbit at its present or at any other position, provided the required obstacle clearance is ensured.

6.5.6 Approach sequence

6.5.6.1 GENERAL

The following procedures shall be applied whenever approaches are in progress.

6.5.6.1.1 The approach sequence shall be established in a manner which will facilitate arrival of the maximum number of aircraft with the least average delay. Priority shall be given to:

- a) an aircraft which anticipates being compelled to land because of factors affecting the safe operation of the aircraft (engine failure, shortage of fuel, etc.);
- b) hospital aircraft or aircraft carrying any sick or seriously injured person requiring urgent medical attention;
- c) aircraft engaged in search and rescue operations; and
- d) other aircraft as may be determined by the appropriate authority.

Note.— An aircraft which has encountered an emergency is handled as outlined in Chapter 15, Section 15.1.

6.5.6.1.2 Succeeding aircraft shall be cleared for approach:

- a) when the preceding aircraft has reported that it is able to complete its approach without encountering instrument meteorological conditions; or
- b) when the preceding aircraft is in communication with and sighted by the aerodrome control tower, and reasonable assurance exists that a normal landing can be accomplished; or
- c) when timed approaches are used, the preceding aircraft has passed the defined point inbound, and reasonable assurance exists that a normal landing can be accomplished;

Note.— See 6.5.6.2.1 concerning timed approach procedures.

- d) when the use of an ATS surveillance system confirms that the required longitudinal spacing between succeeding aircraft has been established.

6.5.6.1.3 In establishing the approach sequence, the need for increased longitudinal spacing between arriving aircraft due to wake turbulence shall be taken into account.

6.5.6.1.4 If the pilot of an aircraft in an approach sequence has indicated an intention to hold for weather improvement, or for other reasons, such action shall be approved. However, when other holding aircraft indicate intention to continue their approach to land, the pilot desiring to hold will be cleared to an adjacent fix for holding awaiting weather change or re-routing. Alternatively, the aircraft should be given a clearance to place it at the top of the approach sequence so that other holding aircraft may be permitted to land. Coordination shall be effected with any adjacent ATC unit or control sector, when required, to avoid conflict with the traffic under the jurisdiction of that unit or sector.

6.5.6.1.5 When establishing the approach sequence, an aircraft which has been authorized to absorb a specified period of notified terminal delay by cruising at a reduced speed en route, should, in so far as practicable, be credited with the time absorbed en route.

6.5.6.2 SEQUENCING AND SPACING OF INSTRUMENT APPROACHES

6.5.6.2.1 TIMED APPROACH PROCEDURES

6.5.6.2.1.1 Subject to approval by the appropriate ATS authority, the following procedure should be utilized as necessary to expedite the approaches of a number of arriving aircraft:

- a) a suitable point on the approach path, which shall be capable of being accurately determined by the pilot, shall be specified, to serve as a checkpoint in timing successive approaches;
- b) aircraft shall be given a time at which to pass the specified point inbound, which time shall be determined with the aim of achieving the desired interval between successive landings on the runway while respecting the applicable separation minima at all times, including the period of runway occupancy.

6.5.6.2.1.2 The time at which aircraft should pass the specified point shall be determined by the unit providing approach control service and notified to the aircraft sufficiently in advance to permit the pilot to arrange the flight path accordingly.

6.5.6.2.1.3 Each aircraft in the approach sequence shall be cleared to pass the specified point inbound at the previously notified time, or any revision thereof, after the preceding aircraft has reported passing the point inbound.

6.5.6.2.2 INTERVAL BETWEEN SUCCESSIVE APPROACHES

In determining the time interval or longitudinal distance to be applied between successive approaching aircraft, the relative speeds between succeeding aircraft, the distance from the specified point to the runway, the need to apply wake turbulence separation, runway occupancy times, the prevailing meteorological conditions as well as any condition which may affect runway occupancy times shall be considered. When an ATS surveillance system is used to establish an approach sequence, the minimum distance to be established between succeeding aircraft shall be specified in local instructions. Local instructions shall additionally specify the circumstances under which any increased longitudinal distance between approaches may be required as well as the minima to be used under such circumstances.

6.5.6.2.3 INFORMATION ON APPROACH SEQUENCE

Provision shall be made to ensure that the aerodrome control tower is kept informed of the sequence in which aircraft will be established on final approach for landing.

Note 1.— Guidance material on factors to be taken into account when determining separation for timed approaches is contained in the Air Traffic Services Planning Manual (Doc 9426).

Note 2.— Wake turbulence categories and wake turbulence separation minima are contained in Chapter 4, Section 4.9, Chapter 5, Section 5.8 and Chapter 8, Section 8.7.

Note 3.— Detailed characteristics of wake vortices and their effect on aircraft are contained in the Air Traffic Services Planning Manual (Doc 9426), Part II, Section 5.

6.5.7 Expected approach time

6.5.7.1 An expected approach time shall be determined for an arriving aircraft that will be subjected to a delay of 10 minutes or more or such other period as has been determined by the appropriate authority. The expected approach time shall be transmitted to the aircraft as soon as practicable and preferably not later than at the commencement of its initial descent from cruising level. A revised expected approach time shall be transmitted to the aircraft without delay whenever it differs from that previously transmitted by 5 minutes or more, or such lesser period of time as has been established by the appropriate ATS authority or agreed between the ATS units concerned.

6.5.7.2 An expected approach time shall be transmitted to the aircraft by the most expeditious means whenever it is anticipated that the aircraft will be required to hold for 30 minutes or more.

6.5.7.3 The holding fix to which an expected approach time relates shall be identified together with the expected approach time whenever circumstances are such that this would not otherwise be evident to the pilot.

6.5.8 Onward clearance time

In the event an aircraft is held en route or at a location or aid other than the initial approach fix, the aircraft concerned shall, as soon as practicable, be given an expected onward clearance time from the holding fix. The aircraft shall also be advised if further holding at a subsequent holding fix is expected.

Note.— “Onward clearance time” is the time at which an aircraft can expect to leave the fix at which it is being held.

6.6 INFORMATION FOR ARRIVING AIRCRAFT

Note.— See Chapter 11, 11.4.3, regarding flight information messages.

6.6.1 As early as practicable after an aircraft has established communication with the unit providing approach control service, the following elements of information, in the order listed, shall be transmitted to the aircraft, with the exception of such elements which it is known the aircraft has already received:

- a) type of approach and runway-in-use;
- b) meteorological information, as follows:
 - 1) surface wind direction and speed, including significant variations;
 - 2) visibility and, when applicable, runway visual range (RVR);
 - 3) present weather;

- 4) cloud below 1 500 m (5 000 ft) or below the highest minimum sector altitude, whichever is greater; cumulonimbus; if the sky is obscured, vertical visibility when available;
- 5) air temperature;
- 6) dew point temperature, inclusion determined on the basis of a regional air navigation agreement;
- 7) altimeter setting(s);
- 8) any available information on significant meteorological phenomena in the approach area; and
- 9) trend-type landing forecast, when available.

Note.— The meteorological information listed above is identical to that required in ATIS broadcasts for arriving aircraft as specified in Annex 11, 4.3.7 l) to t), and is to be extracted from local meteorological routine and special reports, in accordance with Chapter 11, 11.4.3.2.2 to 11.4.3.2.3.

- c) current runway surface conditions, in case of precipitants or other temporary hazards;
- d) changes in the operational status of visual and non-visual aids essential for approach and landing.

6.6.2 In applying the provisions in 6.7.3.1.1, it should be recognized that information published by NOTAM or disseminated by other means may not have been received by the aircraft prior to departure or during en-route flight.

6.6.3 If it becomes necessary or operationally desirable that an arriving aircraft follow an instrument approach procedure or use a runway other than that initially stated, the flight crew shall be advised without delay.

6.6.4 At the commencement of final approach, the following information shall be transmitted to aircraft:

- a) significant changes in the mean surface wind direction and speed;

Note.— Significant changes are specified in Annex 3, Chapter 4. However, if the controller possesses wind information in the form of components, the significant changes are:

- Mean headwind component: 19 km/h (10 kt)
- Mean tailwind component: 4 km/h (2 kt)
- Mean crosswind component: 9 km/h (5 kt)

- b) the latest information, if any, on wind shear and/or turbulence in the final approach area;
- c) the current visibility representative of the direction of approach and landing or, when provided, the current runway visual range value(s) and the trend.

6.6.5 During final approach, the following information shall be transmitted without delay:

- a) the sudden occurrence of hazards (e.g. unauthorized traffic on the runway);
- b) significant variations in the current surface wind, expressed in terms of minimum and maximum values;
- c) significant changes in runway surface conditions;
- d) changes in the operational status of required visual or non-visual aids;

- e) changes in observed RVR value(s), in accordance with the reported scale in use, or changes in the visibility representative of the direction of approach and landing.

6.7 OPERATIONS ON PARALLEL OR NEAR-PARALLEL RUNWAYS

6.7.1 General

Where parallel or near-parallel runways are used for simultaneous operations, the requirements and procedures below shall apply.

Note.— Guidance material is contained in the Manual on Simultaneous Operations on Parallel or Near-Parallel Instrument Runways (SOIR) (Doc 9643).

6.7.2 Departing aircraft

6.7.2.1 TYPES OF OPERATION

Parallel runways may be used for independent instrument departures as follows:

- a) both runways are used exclusively for departures (independent departures);
- b) one runway is used exclusively for departures while the other runway is used for a mixture of arrivals and departures (semi-mixed operation); and
- c) both runways are used for mixed arrivals and departures (mixed operation).

6.7.2.2 REQUIREMENTS AND PROCEDURES FOR INDEPENDENT PARALLEL DEPARTURES

Independent IFR departures may be conducted from parallel runways provided:

- a) the runway centre lines are spaced by the distance specified in Annex 14, Volume I;
- b) the departure tracks diverge by at least 15 degrees immediately after take-off;
- c) suitable surveillance radar capable of identification of the aircraft within 2 km (1.0 NM) from the end of the runway is available; and
- d) ATS operational procedures ensure that the required track divergence is achieved.

6.7.3 Arriving aircraft

6.7.3.1 TYPES OF OPERATIONS

6.7.3.1.1 Parallel runways may be used for simultaneous instrument operations for:

- a) independent parallel approaches; or
- b) dependent parallel approaches; or
- c) segregated parallel operations.

6.7.3.1.2 Whenever parallel approaches are carried out, separate controllers should be responsible for the sequencing and spacing of arriving aircraft to each runway.

6.7.3.2 REQUIREMENTS AND PROCEDURES FOR INDEPENDENT PARALLEL APPROACHES

6.7.3.2.1 Independent parallel approaches may be conducted to parallel runways provided that:

- a) the runway centre lines are spaced by the distance specified in Annex 14, Volume I:
 - 1) where runway centre lines are spaced by less than 1 310 m but not less than 1 035 m, suitable secondary surveillance radar (SSR) equipment, with a minimum azimuth accuracy of 0.06 degrees (one sigma), an update period of 2.5 seconds or less and a high resolution display providing position prediction and deviation alert is available; or
 - 2) where runway centre lines are spaced by less than 1 525 m but not less than 1 310 m, SSR equipment with performance specifications other than the foregoing may be applied, provided they are equal to or better than those stated under 3) below, and when it is determined that the safety of aircraft operation would not be adversely affected; or
 - 3) where runway centre lines are spaced by 1 525 m or more, suitable surveillance radar with a minimum azimuth accuracy of 0.3 degrees (one sigma) or better and update period of 5 seconds or less is available;

For the above cases, other equivalent ATS surveillance systems (e.g. ADS-B or MLAT) may be used to provide the services detailed above provided that a performance capability equal to or better than that required for the above can be demonstrated.

Note.— Guidance material pertaining to use of ADS-B and multilateration (MLAT) systems and their system performance is contained in the Assessment of ADS-B and Multilateration Surveillance to Support Air Traffic Services and Guidelines for Implementation (Cir 326).

- b) instrument landing system (ILS) and/or microwave landing system (MLS) approaches are being conducted on both runways;
- c) the missed approach track for one approach diverges by at least 30 degrees from the missed approach track of the adjacent approach;
- d) an obstacle survey and evaluation is completed, as appropriate, for the areas adjacent to the final approach segments;
- e) aircraft are advised of the runway identification and ILS localizer or MLS frequency as early as possible;
- f) vectoring is used to intercept the ILS localizer course or the MLS final approach track;
- g) a no transgression zone (NTZ) at least 610 m (2 000 ft) wide is established equidistant between extended runway centre lines and is depicted on the situation display;
- h) separate controllers monitor the approaches to each runway and ensure that when the 300 m (1 000 ft) vertical separation is reduced:
 - 1) aircraft do not penetrate the depicted NTZ; and

- 2) the applicable minimum longitudinal separation between aircraft on the same ILS localizer course or MLS final approach track is maintained; and
- i) if no dedicated radio channels are available for the controllers to control the aircraft until landing:
 - 1) transfer of communication of aircraft to the respective aerodrome controller's channel is effected before the higher of two aircraft on adjacent final approach tracks intercepts the ILS glide path or the specified MLS elevation angle; and
 - 2) the controllers monitoring the approaches to each runway are provided with the capability to override transmissions of aerodrome control on the respective radio channels for each arrival flow.

6.7.3.2.2 As early as practicable after an aircraft has established communication with approach control, the aircraft shall be advised that independent parallel approaches are in force. This information may be provided through the ATIS broadcasts.

6.7.3.2.3 When vectoring to intercept the ILS localizer course or MLS final approach track, the final vector shall enable the aircraft to intercept the ILS localizer course or MLS final approach track at an angle not greater than 30 degrees and to provide at least 2 km (1.0 NM) straight and level flight prior to ILS localizer course or MLS final approach track intercept. The vector shall also enable the aircraft to be established on the ILS localizer course or MLS final approach track in level flight for at least 3.7 km (2.0 NM) prior to intercepting the ILS glide path or specified MLS elevation angle.

6.7.3.2.4 A minimum of 300 m (1 000 ft) vertical separation or, subject to radar system and situation display capabilities, a minimum of 5.6 km (3.0 NM) radar separation shall be provided until aircraft are established:

- a) inbound on the ILS localizer course and/or MLS final approach track; and
- b) within the normal operating zone (NOZ).

6.7.3.2.5 Subject to radar system and situation display capabilities, a minimum of 5.6 km (3.0 NM) radar separation shall be provided between aircraft on the same ILS localizer course or MLS final approach track unless increased longitudinal separation is required due to wake turbulence or for other reasons.

Note 1.— See Chapter 8, 8.7.3.4.

Note 2.— An aircraft established on an ILS localizer course or MLS final approach track is separated from another aircraft established on an adjacent parallel ILS localizer course or MLS final approach track provided neither aircraft penetrates the NTZ as depicted on the situation display.

6.7.3.2.6 When assigning the final heading to intercept the ILS localizer course or MLS final approach track, the runway shall be confirmed, and the aircraft shall be advised of:

- a) its position relative to a fix on the ILS localizer course or MLS final approach track;
- b) the altitude to be maintained until established on the ILS localizer course or MLS final approach track to the ILS glide path or specified MLS elevation angle intercept point; and
- c) if required, clearance for the appropriate ILS or MLS approach.

6.7.3.2.7 All approaches regardless of meteorological conditions shall be provided with flight path monitoring using radar. Control instructions and information necessary to ensure separation between aircraft and to ensure aircraft do not enter the NTZ shall be issued.

Note 1.— The primary responsibility for navigation on the ILS localizer course and/or MLS final approach track rests with the pilot. Control instructions and information are therefore issued only to ensure separation between aircraft and to ensure that aircraft do not penetrate the NTZ.

Note 2.— For the purpose of ensuring an aircraft does not penetrate the NTZ, the aircraft is considered to be the centre of its position symbol. However, the edges of the position symbols representing aircraft executing parallel approaches are not allowed to touch (see Chapter 8, 8.7.2).

6.7.3.2.8 When an aircraft is observed to overshoot the turn-on or to continue on a track which will penetrate the NTZ, the aircraft shall be instructed to return immediately to the correct track.

6.7.3.2.9 When an aircraft is observed penetrating the NTZ, the aircraft on the adjacent ILS localizer course or MLS final approach track shall be instructed to immediately climb and turn to the assigned altitude/height and heading in order to avoid the deviating aircraft. Where parallel approach obstacle assessment surfaces (PAOAS) criteria are applied for the obstacle assessment, the air traffic controller shall not issue the heading instruction to the aircraft below 120 m (400 ft) above the runway threshold elevation, and the heading instruction shall not exceed 45 degrees track difference with the ILS localizer course or MLS final approach track.

6.7.3.2.10 Flight path monitoring using radar shall not be terminated until:

- a) visual separation is applied, provided procedures ensure that both controllers are advised whenever visual separation is applied;
- b) the aircraft has landed, or in case of a missed approach, is at least 2 km (1.0 NM) beyond the departure end of the runway and adequate separation with any other traffic is established.

Note.— There is no requirement to advise the aircraft that flight path monitoring using radar is terminated.

6.7.3.3 SUSPENSION OF INDEPENDENT PARALLEL APPROACHES TO CLOSELY-SPACED PARALLEL RUNWAYS

Independent parallel approaches to parallel runways spaced by less than 1 525 m between their centre lines shall be suspended under certain meteorological conditions, as prescribed by the appropriate ATS authority, including wind shear, turbulence, downdrafts, crosswind and significant meteorological conditions such as thunderstorms, which might otherwise increase ILS localizer course and/ or MLS final approach track deviations to the extent that safety may be impaired.

Note 1.— The increase in final approach track deviations would additionally result in an unacceptable level of deviation alerts being generated.

Note 2.— Guidance material relating to meteorological conditions is contained in the Manual on Simultaneous Operations on Parallel or Near-Parallel Instrument Runways (SOIR) (Doc 9643).

6.7.3.4 REQUIREMENTS AND PROCEDURES FOR DEPENDENT PARALLEL APPROACHES

6.7.3.4.1 Dependent parallel approaches may be conducted to parallel runways provided:

- a) the runway centre lines are spaced by the distance specified in Annex 14, Volume I;
- b) the aircraft are vectored to intercept the final approach track;
- c) suitable surveillance radar with a minimum azimuth accuracy of 0.3 degrees (one sigma) and update period of 5 seconds or less is available;
- d) ILS and/or MLS approaches are being conducted on both runways;

- e) aircraft are advised that approaches are in use to both runways (this information may be provided through the ATIS);
- f) the missed approach track for one approach diverges by at least 30 degrees from the missed approach track of the adjacent approach; and
- g) approach control has a frequency override capability to aerodrome control.

6.7.3.4.2 A minimum of 300 m (1 000 ft) vertical separation or a minimum of 5.6 km (3.0 NM) radar separation shall be provided between aircraft during turn-on to parallel ILS localizer courses and/or MLS final approach tracks.

6.7.3.4.3 The minimum radar separation to be provided between aircraft established on the ILS localizer course and/or MLS final approach track shall be:

- a) 5.6 km (3.0 NM) between aircraft on the same ILS localizer course or MLS final approach track unless increased longitudinal separation is required due to wake turbulence; and
- b) 3.7 km (2.0 NM) between successive aircraft on adjacent ILS localizer courses or MLS final approach tracks.

6.7.3.5 REQUIREMENTS AND PROCEDURES FOR SEGREGATED PARALLEL OPERATIONS

6.7.3.5.1 Segregated parallel operations may be conducted on parallel runways provided:

- a) the runway centre lines are spaced by the distance specified in Annex 14, Volume I; and
- b) the nominal departure track diverges immediately after take-off by at least 30 degrees from the missed approach track of the adjacent approach (see Figure 6-1).

6.7.3.5.2 The minimum distance between parallel runway centre lines for segregated parallel operations may be decreased by 30 m for each 150 m that the arrival runway is staggered toward the arriving aircraft, to a minimum of 300 m (see Figure 6-2) and should be increased by 30 m for each 150 m that the arrival runway is staggered away from the arriving aircraft (see Figure 6-3).

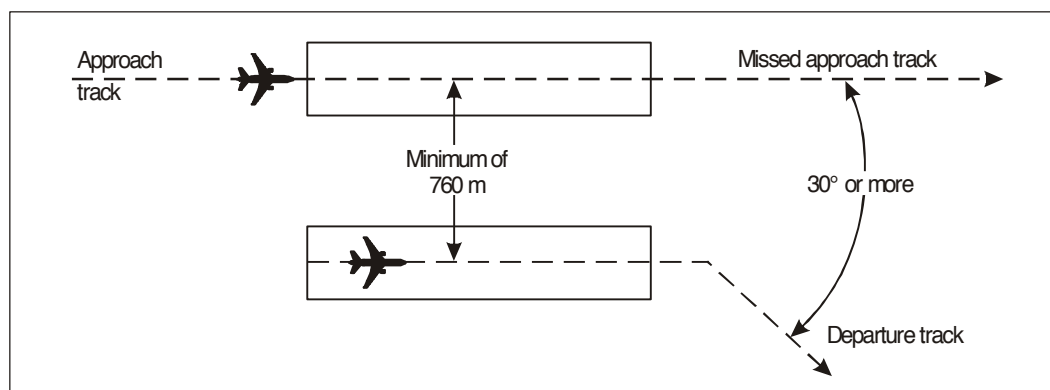

Figure 6-1. Segregated parallel operations (see 6.7.3.5.1 b))

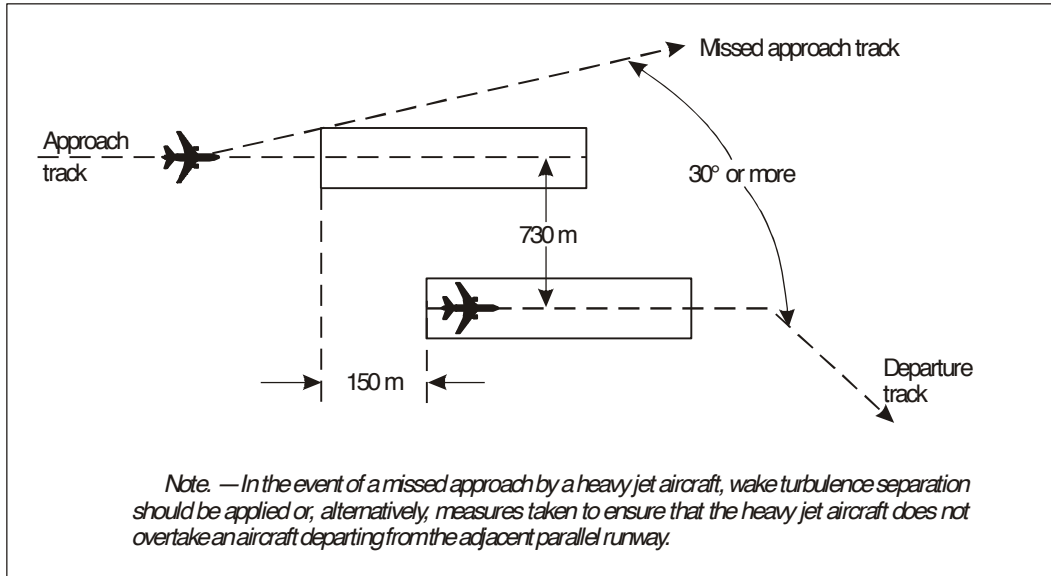

Figure 6-2. Segregated parallel operations where runways are staggered
(see 6.7.3.5.2)

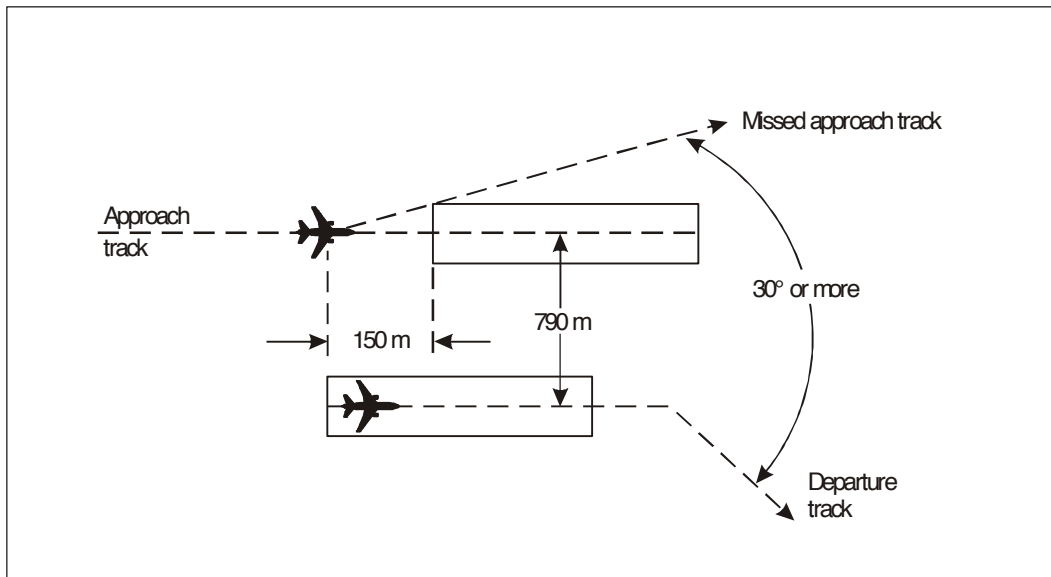

Figure 6-3. Segregated parallel operations where runways are staggered
(see 6.7.3.5.2)

6.7.3.5.3 The following types of approaches may be conducted in segregated parallel operations provided suitable surveillance radar and the appropriate ground facilities conform to the standard necessary for the specific type of approach:

- a) ILS and/or MLS precision approach;
- b) surveillance radar approach (SRA) or precision approach radar (PAR) approach; and
- c) visual approach.

Note.— *Guidance material is contained in the Manual on Simultaneous Operations on Parallel or Near-Parallel Instrument Runways (SOIR) (Doc 9643).*

Chapter 7

PROCEDURES FOR AERODROME CONTROL SERVICE

Note.— This Chapter also includes procedures for the operation of aeronautical ground lights, see Section 7.15.

7.1 FUNCTIONS OF AERODROME CONTROL TOWERS

7.1.1 General

7.1.1.1 Aerodrome control towers shall issue information and clearances to aircraft under their control to achieve a safe, orderly and expeditious flow of air traffic on and in the vicinity of an aerodrome with the object of preventing collision(s) between:

- a) aircraft flying within the designated area of responsibility of the control tower, including the aerodrome traffic circuits;
- b) aircraft operating on the manoeuvring area;
- c) aircraft landing and taking off;
- d) aircraft and vehicles operating on the manoeuvring area;
- e) aircraft on the manoeuvring area and obstructions on that area.

7.1.1.2 Aerodrome controllers shall maintain a continuous watch on all flight operations on and in the vicinity of an aerodrome as well as vehicles and personnel on the manoeuvring area. Watch shall be maintained by visual observation, augmented in low visibility conditions by an ATS surveillance system when available. Traffic shall be controlled in accordance with the procedures set forth herein and all applicable traffic rules specified by the appropriate ATS authority. If there are other aerodromes within a control zone, traffic at all aerodromes within such a zone shall be coordinated so that traffic circuits do not conflict.

Note.— Provisions for the use of an ATS surveillance system in the aerodrome control service are contained in Chapter 8, Section 8.10.

7.1.1.3 The functions of an aerodrome control tower may be performed by different control or working positions, such as:

- a) aerodrome controller, normally responsible for operations on the runway and aircraft flying within the area of responsibility of the aerodrome control tower;
- b) ground controller, normally responsible for traffic on the manoeuvring area with the exception of runways;
- c) clearance delivery position, normally responsible for delivery of start-up and ATC clearances to departing IFR flights.

7.1.1.4 Where parallel or near-parallel runways are used for simultaneous operations, individual aerodrome controllers should be responsible for operations on each of the runways.

7.1.2 Alerting service provided by aerodrome control towers

7.1.2.1 Aerodrome control towers are responsible for alerting the rescue and fire fighting services whenever:

- a) an aircraft accident has occurred on or in the vicinity of the aerodrome; or
- b) information is received that the safety of an aircraft which is or will come under the jurisdiction of the aerodrome control tower may have or has been impaired; or
- c) requested by the flight crew; or
- d) when otherwise deemed necessary or desirable.

7.1.2.2 Procedures concerning the alerting of the rescue and fire fighting services shall be contained in local instructions. Such instructions shall specify the type of information to be provided to the rescue and fire fighting services, including type of aircraft and type of emergency and, when available, number of persons on board, and any dangerous goods carried on the aircraft.

7.1.2.3 Aircraft which fail to report after having been transferred to an aerodrome control tower, or, having once reported, cease radio contact and in either case fail to land five minutes after the expected landing time, shall be reported to the approach control unit, ACC or flight information centre, or to the rescue coordination centre or rescue sub-centre, in accordance with local instructions.

7.1.3 Failure or irregularity of aids and equipment

Aerodrome control towers shall immediately report in accordance with local instructions any failure or irregularity of operation in any equipment, light or other device established at an aerodrome for the guidance of aerodrome traffic and flight crews or required for the provision of air traffic control service.

7.2 SELECTION OF RUNWAY-IN-USE

7.2.1 The term “runway-in-use” shall be used to indicate the runway or runways that, at a particular time, are considered by the aerodrome control tower to be the most suitable for use by the types of aircraft expected to land or take off at the aerodrome.

Note.— Separate or multiple runways may be designated runway-in-use for arriving aircraft and departing aircraft.

7.2.2 Normally, an aircraft will land and take off into wind unless safety, the runway configuration, meteorological conditions and available instrument approach procedures or air traffic conditions determine that a different direction is preferable. In selecting the runway-in-use, however, the unit providing aerodrome control service shall take into consideration, besides surface wind speed and direction, other relevant factors such as the aerodrome traffic circuits, the length of runways, and the approach and landing aids available.

7.2.3 A runway for take-off or landing, appropriate to the operation, may be nominated for noise abatement purposes, the objective being to utilize whenever possible those runways that permit aeroplanes to avoid noise-sensitive areas during the initial departure and final approach phases of flight.

7.2.4 Runways should not be selected for noise abatement purposes for landing operations unless they are equipped with suitable glide path guidance, e.g. ILS, or a visual approach slope indicator system for operations in visual meteorological conditions.

7.2.5 A pilot-in-command, prompted by safety concerns, can refuse a runway offered for noise-preferential reasons.

7.2.6 Noise abatement shall not be a determining factor in runway nomination under the following circumstances:

- a) if the runway surface conditions are adversely affected (e.g. by snow, slush, ice, water, mud, rubber, oil or other substances);
- b) for landing in conditions:
 - 1) when the ceiling is lower than 150 m (500 ft) above aerodrome elevation, or the visibility is less than 1 900 m; or
 - 2) when the approach requires use to be made of vertical minima greater than 100 m (300 ft) above aerodrome elevation and:
 - i) the ceiling is lower than 240 m (800 ft) above aerodrome elevation; or
 - ii) the visibility is less than 3 000 m;
- c) for take-off when the visibility is less than 1 900 m;
- d) when wind shear has been reported or forecast or when thunderstorms are expected to affect the approach or departure; and
- e) when the crosswind component, including gusts, exceeds 28 km/h (15 kt), or the tailwind component, including gusts, exceeds 9 km/h (5 kt).

7.3 INITIAL CALL TO AERODROME CONTROL TOWER

For aircraft being provided with aerodrome control service, the initial call shall contain:

- a) designation of the station being called;
- b) call sign and, for aircraft in the heavy wake turbulence category, the word “Heavy”;
- c) position; and
- d) additional elements, as required by the appropriate ATS authority.

Note.— See also Chapter 4, 4.11.3.1, for aircraft in the air, making the first call to the aerodrome tower.

7.4 INFORMATION TO AIRCRAFT BY AERODROME CONTROL TOWERS

7.4.1 Information related to the operation of aircraft

Note.— See Chapter 11, 11.4.3, regarding flight information messages.

7.4.1.1 START-UP TIME PROCEDURES

7.4.1.1.1 When so requested by the pilot prior to engine start, an expected take-off time should be given, unless engine start-up time procedures are employed.

7.4.1.1.2 Start-up time procedures should be implemented where necessary to avoid congestion and excessive delays on the manoeuvring area or when warranted by ATFM regulations. Start-up time procedures should be contained in local instructions, and should specify the criteria and conditions for determining when and how start-up times shall be calculated and issued to departing flights.

7.4.1.1.3 When an aircraft is subject to ATFM regulations, it should be advised to start up in accordance with its allocated slot time.

7.4.1.1.4 When the delay for a departing aircraft is anticipated to be less than a time period specified by the appropriate ATS authority, an aircraft should be cleared to start up at its own discretion.

7.4.1.1.5 When the delay for a departing aircraft is anticipated to exceed a time period specified by the appropriate ATS authority, the aerodrome control tower should issue an expected start-up time to an aircraft requesting start-up.

7.4.1.1.6 A start-up clearance shall only be withheld under circumstances or conditions specified by the appropriate ATS authority.

7.4.1.1.7 If a start-up clearance is withheld, the flight crew shall be advised of the reason.

7.4.1.2 AERODROME AND METEOROLOGICAL INFORMATION

7.4.1.2.1 Prior to taxiing for take-off, aircraft shall be advised of the following elements of information, in the order listed, with the exception of such elements which it is known the aircraft has already received:

- a) the runway to be used;
- b) the surface wind direction and speed, including significant variations therefrom;
- c) the QNH altimeter setting and, either on a regular basis in accordance with local arrangements or if so requested by the aircraft, the QFE altimeter setting;
- d) the air temperature for the runway to be used, in the case of turbine-engined aircraft;
- e) the visibility representative of the direction of take-off and initial climb, if less than 10 km, or, when applicable, the RVR value(s) for the runway to be used;
- f) the correct time.

Note.— The meteorological information listed above is to follow the criteria used for meteorological local routine and special reports, in accordance with Chapter 11, 11.4.3.2.2 to 11.4.3.2.3.

7.4.1.2.2 Prior to take-off aircraft shall be advised of:

- a) any significant changes in the surface wind direction and speed, the air temperature, and the visibility or RVR value(s) given in accordance with 7.4.1.2.1;
- b) significant meteorological conditions in the take-off and climb-out area, except when it is known that the information has already been received by the aircraft.

Note.— Significant meteorological conditions in this context include the occurrence or expected occurrence of cumulonimbus or thunderstorm, moderate or severe turbulence, wind shear, hail, moderate or severe icing, severe squall line, freezing precipitation, severe mountain waves, sandstorm, duststorm, blowing snow, tornado or waterspout in the take-off and climb-out area.

7.4.1.2.3 Prior to entering the traffic circuit or commencing its approach to land, an aircraft shall be provided with the following elements of information, in the order listed, with the exception of such elements which it is known the aircraft has already received:

- a) the runway to be used;
- b) the surface wind direction and speed, including significant variations therefrom;
- c) the QNH altimeter setting and, either on a regular basis in accordance with local arrangements or if so requested by the aircraft, the QFE altimeter setting.

Note.— The meteorological information listed above is to follow the criteria used for meteorological local routine and special reports, in accordance with Chapter 11, 11.4.3.2.2 to 11.4.3.2.3.

7.4.1.3 ESSENTIAL LOCAL TRAFFIC INFORMATION

7.4.1.3.1 Information on essential local traffic shall be issued in a timely manner, either directly or through the unit providing approach control service when, in the judgement of the aerodrome controller, such information is necessary in the interests of safety, or when requested by aircraft.

7.4.1.3.2 Essential local traffic shall be considered to consist of any aircraft, vehicle or personnel on or near the manoeuvring area, or traffic operating in the vicinity of the aerodrome, which may constitute a hazard to the aircraft concerned.

7.4.1.3.3 Essential local traffic shall be described so as to be easily identified.

7.4.1.4 RUNWAY INCURSION OR OBSTRUCTED RUNWAY

7.4.1.4.1 In the event the aerodrome controller, after a take-off clearance or a landing clearance has been issued, becomes aware of a runway incursion or the imminent occurrence thereof, or the existence of any obstruction on or in close proximity to the runway likely to impair the safety of an aircraft taking off or landing, appropriate action shall be taken as follows:

- a) cancel the take-off clearance for a departing aircraft;
- b) instruct a landing aircraft to execute a go-around or missed approach;
- c) in all cases inform the aircraft of the runway incursion or obstruction and its location in relation to the runway.

Note.— Animals and flocks of birds may constitute an obstruction with regard to runway operations. In addition, an aborted take-off or a go-around executed after touchdown may expose the aeroplane to the risk of overrunning the runway. Moreover, a low altitude missed approach may expose the aeroplane to the risk of a tail strike. Pilots may, therefore, have to exercise their judgement in accordance with Annex 2, 2.4, concerning the authority of the pilot-in-command of an aircraft.

7.4.1.4.2 Pilots and air traffic controllers shall report any occurrence involving an obstruction on the runway or a runway incursion.

Note 1.— Information regarding runway incursions' reporting forms together with instructions for their completion are contained in the Manual on the Prevention of Runway Incursions (Doc 9870). Attention is drawn to the guidance for analysis, data collection and sharing of data related to runway incursions/incidents (see Chapter 5 of Doc 9870).

Note 2.— The provisions in 7.4.1.4.2 have the objective of supporting the State's safety programme and safety management system (SMS).

7.4.1.5 UNCERTAINTY OF POSITION ON THE MANOEUVRING AREA

7.4.1.5.1 Except as provided for in 7.4.1.5.2, a pilot in doubt as to the position of the aircraft with respect to the manoeuvring area shall immediately:

- a) stop the aircraft; and
- b) simultaneously notify the appropriate ATS unit of the circumstances (including the last known position).

7.4.1.5.2 In those situations where a pilot is in doubt as to the position of the aircraft with respect to the manoeuvring area, but recognizes that the aircraft is on a runway, the pilot shall immediately:

- a) notify the appropriate ATS unit of the circumstances (including the last known position);
- b) if able to locate a nearby suitable taxiway, vacate the runway as expeditiously as possible, unless otherwise instructed by the ATS unit; and then,
- c) stop the aircraft.

7.4.1.5.3 A vehicle driver in doubt as to the position of the vehicle with respect to the manoeuvring area shall immediately:

- a) notify the appropriate ATS unit of the circumstances (including the last known position);
- b) simultaneously, unless otherwise instructed by the ATS unit, vacate the landing area, taxiway, or other part of the manoeuvring area, to a safe distance as expeditiously as possible; and then,
- c) stop the vehicle.

7.4.1.5.4 In the event the aerodrome controller becomes aware of an aircraft or vehicle that is lost or uncertain of its position on the manoeuvring area, appropriate action shall be taken immediately to safeguard operations and assist the aircraft or vehicle concerned to determine its position.

7.4.1.6 WAKE TURBULENCE AND JET BLAST HAZARDS

7.4.1.6.1 Aerodrome controllers shall, when applicable, apply the wake turbulence separation minima specified in Chapter 5, Section 5.8. Whenever the responsibility for wake turbulence avoidance rests with the pilot-in-command, aerodrome controllers shall, to the extent practicable, advise aircraft of the expected occurrence of hazards caused by turbulent wake.

Note.— Occurrence of turbulent wake hazards cannot be accurately predicted and aerodrome controllers cannot assume responsibility for the issuance of advice on such hazards at all times, nor for its accuracy. Information on hazards due to wake vortices is contained in the Air Traffic Services Planning Manual (Doc 9426), Part II, Section 5. Wake turbulence categories of aircraft are specified in Chapter 4, 4.9.1.

7.4.1.6.2 In issuing clearances or instructions, air traffic controllers should take into account the hazards caused by jet blast and propeller slipstream to taxiing aircraft, to aircraft taking off or landing, particularly when intersecting runways are being used, and to vehicles and personnel operating on the aerodrome.

Note.— Jet blast and propeller slipstream can produce localized wind velocities of sufficient strength to cause damage to other aircraft, vehicles and personnel operating within the affected area.

7.4.1.7 ABNORMAL AIRCRAFT CONFIGURATION AND CONDITION

7.4.1.7.1 Whenever an abnormal configuration or condition of an aircraft, including conditions such as landing gear not extended or only partly extended, or unusual smoke emissions from any part of the aircraft, is observed by or reported to the aerodrome controller, the aircraft concerned shall be advised without delay.

7.4.1.7.2 When requested by the flight crew of a departing aircraft suspecting damage to the aircraft, the departure runway used shall be inspected without delay and the flight crew advised in the most expeditious manner as to whether any aircraft debris or bird or animal remains have been found or not.

7.5 ESSENTIAL INFORMATION ON AERODROME CONDITIONS

Note.— See Chapter 11, 11.4.3.4, regarding messages containing information on aerodrome conditions.

7.5.1 Essential information on aerodrome conditions is information necessary to safety in the operation of aircraft, which pertains to the movement area or any facilities usually associated therewith. For example, construction work on a taxi strip not connected to the runway-in-use would not be essential information to any aircraft except one that might be taxied in the vicinity of the construction work. As another example, if all traffic must be confined to runways, that fact should be considered as essential aerodrome information to any aircraft not familiar with the aerodrome.

7.5.2 Essential information on aerodrome conditions shall include information relating to the following:

- a) construction or maintenance work on, or immediately adjacent to the movement area;
- b) rough or broken surfaces on a runway, a taxiway or an apron, whether marked or not;
- c) snow, slush or ice on a runway, a taxiway or an apron;
- d) water on a runway, a taxiway or an apron;
- e) snow banks or drifts adjacent to a runway, a taxiway or an apron;
- f) other temporary hazards, including parked aircraft and birds on the ground or in the air;
- g) failure or irregular operation of part or all of the aerodrome lighting system;
- h) any other pertinent information.

Note.— Up-to-date information on the conditions on aprons may not always be available to the aerodrome control tower. The responsibility of the aerodrome control tower in relation to aprons is, with respect to the provisions of 7.5.1 and 7.5.2, limited to the transmission to aircraft of the information which is provided to it by the authority responsible for the aprons.

7.5.3 Essential information on aerodrome conditions shall be given to every aircraft, except when it is known that the aircraft already has received all or part of the information from other sources. The information shall be given in sufficient time for the aircraft to make proper use of it, and the hazards shall be identified as distinctly as possible.

Note.— “Other sources” include NOTAM, ATIS broadcasts, and the display of suitable signals.

7.5.4 When a not previously notified condition pertaining to the safe use by aircraft of the manoeuvring area is reported to or observed by the controller, the appropriate aerodrome authority shall be informed and operations on that part of the manoeuvring area terminated until otherwise advised by the appropriate aerodrome authority.

7.6 CONTROL OF AERODROME TRAFFIC

7.6.1 General

As the view from the flight deck of an aircraft is normally restricted, the controller shall ensure that instructions and information which require the flight crew to employ visual detection, recognition and observation are phrased in a clear, concise and complete manner.

7.6.2 Designated positions of aircraft in the aerodrome traffic and taxi circuits

The following positions of aircraft in the traffic and taxi circuits are the positions where aircraft normally receive aerodrome control tower clearances. Aircraft should be watched closely as they approach these positions so that proper clearances may be issued without delay. Where practicable, all clearances should be issued without waiting for aircraft to initiate the call.

Position 1. Aircraft initiates call to taxi for departing flight. Runway-in-use information and taxi clearances given.

Position 2. If there is conflicting traffic, the departing aircraft will be held at this position. Engine run-up will, when required, normally be performed here.

Position 3. Take-off clearance is issued here, if not practicable at position 2.

Position 4. Clearance to land is issued here as practicable.

Position 5. Clearance to taxi to apron is issued here.

Position 6. Parking information issued here, if necessary.

Note 1.— Arriving aircraft executing an instrument approach procedure will normally enter the traffic circuit on final except when visual manoeuvring to the landing runway is required.

Note 2.— See Figure 7-1.

7.6.3 Traffic on the manoeuvring area

7.6.3.1 CONTROL OF TAXIING AIRCRAFT

7.6.3.1.1 TAXI CLEARANCE

7.6.3.1.1.1 Prior to issuing a taxi clearance, the controller shall determine where the aircraft concerned is parked. Taxi clearances shall contain concise instructions and adequate information so as to assist the flight crew to follow the correct taxi routes, to avoid collision with other aircraft or objects and to minimize the potential for the aircraft inadvertently entering an active runway.

7.6.3.1.1.2 When a taxi clearance contains a taxi limit beyond a runway, it shall contain an explicit clearance to cross or an instruction to hold short of that runway.

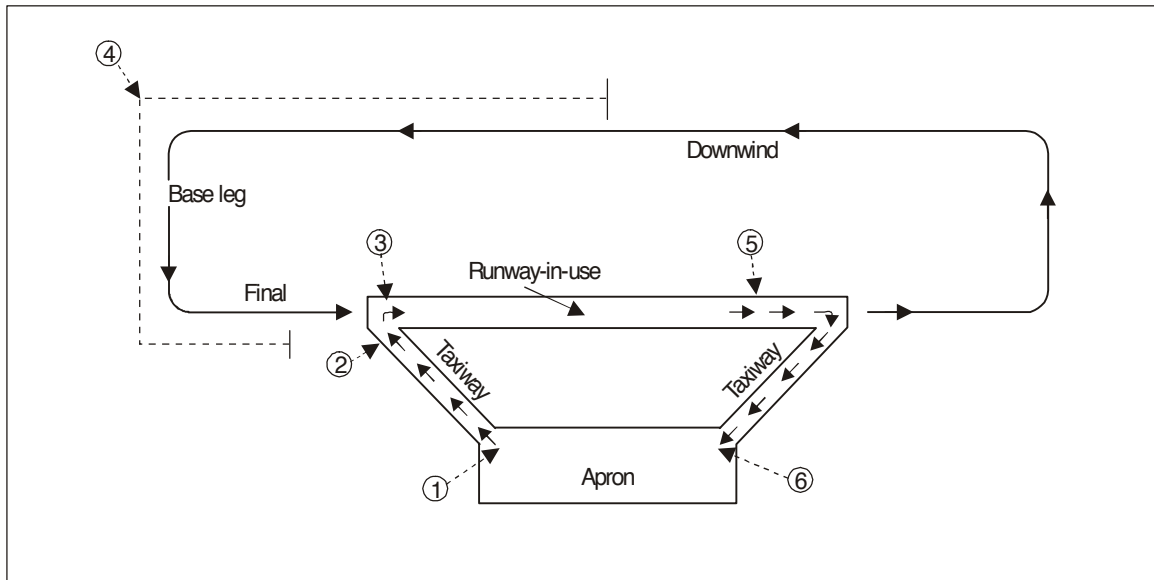

Figure 7-1. Designated positions of aircraft from an aerodrome control tower viewpoint (see 7.6.2)

7.6.3.1.1.3 The appropriate ATS authority should whenever practicable publish in the national AIP standard taxi routes to be used at an aerodrome. Standard taxi routes should be identified by appropriate designators and should be used in taxi clearances.

7.6.3.1.1.4 Where standard taxi routes have not been published, a taxi route should, whenever possible, be described by use of taxiway and runway designators. Other relevant information, such as an aircraft to follow or give way to, shall also be provided to a taxiing aircraft.

7.6.3.1.2 TAXIING ON A RUNWAY-IN-USE

7.6.3.1.2.1 For the purpose of expediting air traffic, aircraft may be permitted to taxi on the runway-in-use, provided no delay or risk to other aircraft will result. Where control of taxiing aircraft is provided by a ground controller and the control of runway operations by an aerodrome controller, the use of a runway by taxiing aircraft shall be coordinated with and approved by the aerodrome controller. Communication with the aircraft concerned should be transferred from the ground controller to the aerodrome controller prior to the aircraft entering the runway.

7.6.3.1.2.2 If the control tower is unable to determine, either visually or via an ATS surveillance system that a vacating or crossing aircraft has cleared the runway, the aircraft shall be requested to report when it has vacated the runway. The report shall be made when the entire aircraft is beyond the relevant runway-holding position.

7.6.3.1.3 USE OF RUNWAY-HOLDING POSITIONS

7.6.3.1.3.1 Except as provided in 7.6.3.1.3.2 or as prescribed by the appropriate ATS authority, aircraft shall not be held closer to a runway-in-use than at a runway-holding position.

Note.— Runway-holding position locations in relation to runways are specified in Annex 14, Volume I, Chapter 5.

7.6.3.1.3.2 Aircraft shall not be permitted to line up and hold on the approach end of a runway-in-use whenever another aircraft is effecting a landing, until the landing aircraft has passed the point of intended holding.

Note.— See Figure 7-2.

7.6.3.1.4 HELICOPTER TAXIING OPERATIONS

7.6.3.1.4.1 When necessary for a wheeled helicopter or vertical take-off and landing (VTOL) aircraft to taxi on the surface, the following provisions are applicable.

Note.— Ground taxiing uses less fuel than air-taxiing and minimizes air turbulence. However, under certain conditions, such as rough, soft or uneven terrain, it may become necessary to air-taxi for safety considerations. Helicopters with articulating rotors (usually designs with three or more main rotor blades) are subject to “ground resonance” and may, on rare occasions, suddenly lift off the ground to avoid severe damage or destruction.

7.6.3.1.4.2 When it is requested or necessary for a helicopter to proceed at a slow speed above the surface, normally below 37 km/h (20 kt) and in ground effect, air-taxiing may be authorized.

Note.— Air-taxiing consumes fuel at a high burn rate, and helicopter downwash turbulence (produced in ground effect) increases significantly with larger and heavier helicopters.

7.6.3.1.4.3 Instructions which require small aircraft or helicopters to taxi in close proximity to taxiing helicopters should be avoided and consideration should be given to the effect of turbulence from taxiing helicopters on arriving and departing light aircraft.

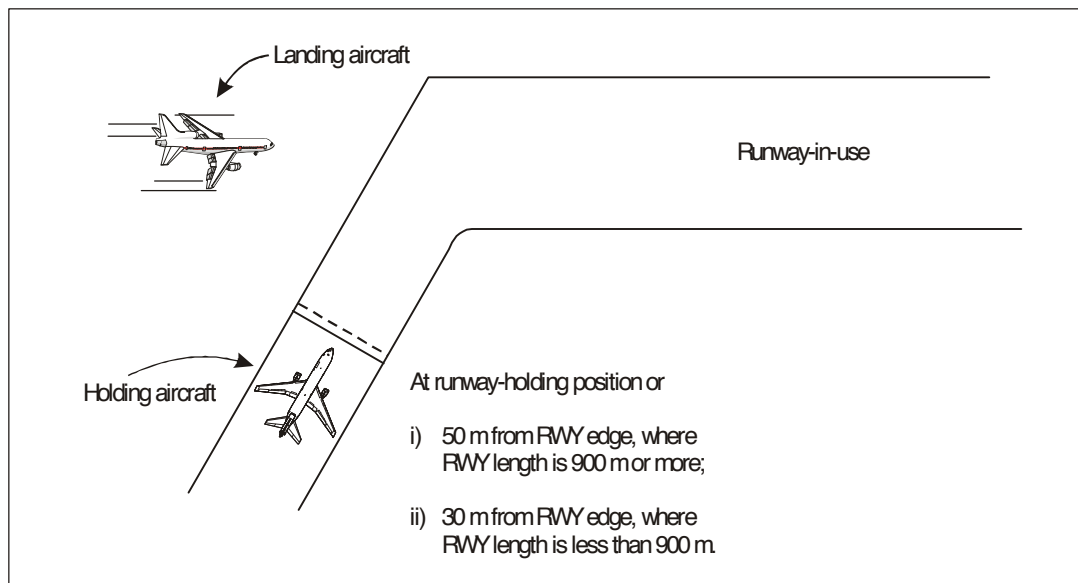

Figure 7-2. Method of holding aircraft (see 7.6.3.1.3.2)

7.6.3.1.4.4 A frequency change should not be issued to single-pilot helicopters hovering or air-taxiing. Whenever possible, control instructions from the next ATS unit should be relayed as necessary until the pilot is able to change frequency.

Note.— Most light helicopters are flown by one pilot and require the constant use of both hands and feet to maintain control during low-altitude/low-level flight. Although flight control friction devices assist the pilot, changing frequency near the ground could result in inadvertent ground contact and consequent loss of control.

7.6.3.2 CONTROL OF OTHER THAN AIRCRAFT TRAFFIC

7.6.3.2.1 ENTRY TO THE MANOEUVRING AREA

The movement of pedestrians or vehicles on the manoeuvring area shall be subject to authorization by the aerodrome control tower. Persons, including drivers of all vehicles, shall be required to obtain authorization from the aerodrome control tower before entry to the manoeuvring area. Notwithstanding such an authorization, entry to a runway or runway strip or change in the operation authorized shall be subject to a further specific authorization by the aerodrome control tower.

7.6.3.2.2 PRIORITY ON THE MANOEUVRING AREA

7.6.3.2.2.1 All vehicles and pedestrians shall give way to aircraft which are landing, taxiing or taking off, except that emergency vehicles proceeding to the assistance of an aircraft in distress shall be afforded priority over all other surface movement traffic. In the latter case, all movement of surface traffic should, to the extent practicable, be halted until it is determined that the progress of the emergency vehicles will not be impeded.

7.6.3.2.2.2 When an aircraft is landing or taking off, vehicles shall not be permitted to hold closer to the runway-in-use than:

- a) at a taxiway/runway intersection — at a runway-holding position; and
- b) at a location other than a taxiway/runway intersection — at a distance equal to the separation distance of the runway-holding position.

7.6.3.2.3 COMMUNICATION REQUIREMENTS AND VISUAL SIGNALS

7.6.3.2.3.1 At controlled aerodromes all vehicles employed on the manoeuvring area shall be capable of maintaining two-way radiocommunication with the aerodrome control tower, except when the vehicle is only occasionally used on the manoeuvring area and is:

- a) accompanied by a vehicle with the required communications capability; or
- b) employed in accordance with a pre-arranged plan established with the aerodrome control tower.

7.6.3.2.3.2 When communications by a system of visual signals is deemed to be adequate, or in the case of radiocommunication failure, the signals given hereunder shall have the meaning indicated therein:

<i>Light signal from aerodrome control</i>	<i>Meaning</i>
Green flashes	Permission to cross landing area or to move onto taxiway
Steady red	Stop
Red flashes	Move off the landing area or taxiway and watch out for aircraft
White flashes	Vacate manoeuvring area in accordance with local instructions

7.6.3.2.3.3 In emergency conditions or if the signals in 7.6.3.2.3.2 are not observed, the signal given hereunder shall be used for runways or taxiways equipped with a lighting system and shall have the meaning indicated therein.

<i>Light signal</i>	<i>Meaning</i>
Flashing runway or taxiway lights	Vacate the runway and observe the tower for light signal

7.6.3.2.3.4 When employed in accordance with a plan prearranged with the aerodrome control tower, constructional and maintenance personnel should not normally be required to be capable of maintaining two-way radiocommunication with the aerodrome control tower.

7.7 CONTROL OF TRAFFIC IN THE TRAFFIC CIRCUIT

7.7.1 General

7.7.1.1 Aircraft in the traffic circuit shall be controlled to provide the separation minima outlined in 7.9.2, 7.10.1 and 7.11 and Chapter 5, Section 5.8, except that:

- a) aircraft in formation are exempted from the separation minima with respect to separation from other aircraft of the same flight;
- b) aircraft operating in different areas or different runways on aerodromes suitable for simultaneous landings or take-offs are exempted from the separation minima;
- c) separation minima shall not apply to aircraft operating under military necessity in accordance with Chapter 16, Section 16.1.

7.7.1.2 Sufficient separation shall be effected between aircraft in flight in the traffic circuit to allow the spacing of arriving and departing aircraft as outlined in 7.9.2, 7.10.1 and 7.11 and Chapter 5, Section 5.8.

7.7.2 Entry of traffic circuit

7.7.2.1 The clearance to enter the traffic circuit should be issued to an aircraft whenever it is desired that the aircraft approach the landing area in accordance with current traffic circuits but traffic conditions do not yet allow a landing clearance to be issued. Depending on the circumstances and traffic conditions, an aircraft may be cleared to join at any position in the traffic circuit.

7.7.2.2 An arriving aircraft executing an instrument approach shall normally be cleared to land straight in unless visual manoeuvring to the landing runway is required.

7.7.3 Priority for landing

7.7.3.1 If an aircraft enters an aerodrome traffic circuit without proper authorization, it shall be permitted to land if its actions indicate that it so desires. If circumstances warrant, aircraft which are in contact with the controller may be instructed by the controller to give way so as to remove as soon as possible the hazard introduced by such unauthorized operation. In no case shall permission to land be withheld indefinitely.

7.7.3.2 In cases of emergency it may be necessary, in the interests of safety, for an aircraft to enter a traffic circuit and effect a landing without proper authorization. Controllers should recognize the possibilities of emergency action and render all assistance possible.

7.7.3.3 Priority shall be given to:

- a) an aircraft which anticipates being compelled to land because of factors affecting the safe operation of the aircraft (engine failure, shortage of fuel, etc.);
- b) hospital aircraft or aircraft carrying any sick or seriously injured persons requiring urgent medical attention;
- c) aircraft engaged in search and rescue operations; and
- d) other aircraft as may be determined by the appropriate authority.

Note.— An aircraft which has encountered an emergency is handled as outlined in Chapter 15, Section 15.1.

7.8 ORDER OF PRIORITY FOR ARRIVING AND DEPARTING AIRCRAFT

An aircraft landing or in the final stages of an approach to land shall normally have priority over an aircraft intending to depart from the same or an intersecting runway.

7.9 CONTROL OF DEPARTING AIRCRAFT

7.9.1 Departure sequence

Departures shall normally be cleared in the order in which they are ready for take-off, except that deviations may be made from this order of priority to facilitate the maximum number of departures with the least average delay. Factors which should be considered in relation to the departure sequence include, *inter alia*:

- a) types of aircraft and their relative performance;
- b) routes to be followed after take-off;
- c) any specified minimum departure interval between take-offs;

- d) need to apply wake turbulence separation minima;
- e) aircraft which should be afforded priority; and
- f) aircraft subject to ATFM requirements.

Note 1.— See also Chapter 6, 6.3.3.

Note 2.— For aircraft subject to ATFM requirements, it is the responsibility of the pilot and the operator to ensure that the aircraft is ready to taxi in time to meet any required departure time, bearing in mind that once a departure sequence is established on the taxiway system, it can be difficult, and sometimes impossible, to change the order.

7.9.2 Separation of departing aircraft

Except as provided in 7.11 and Chapter 5, Section 5.8, a departing aircraft will not normally be permitted to commence take-off until the preceding departing aircraft has crossed the end of the runway-in-use or has started a turn or until all preceding landing aircraft are clear of the runway-in-use.

Note 1.— See Figure 7-3.

Note 2.— Wake turbulence categories and time-based wake turbulence longitudinal separation minima are contained in Chapter 4, Section 4.9 and Chapter 5, Section 5.8, respectively. Distance-based wake turbulence separation minima are contained in Chapter 8, Section 8.7.

Note 3.— See 7.6.3.1.2.2.

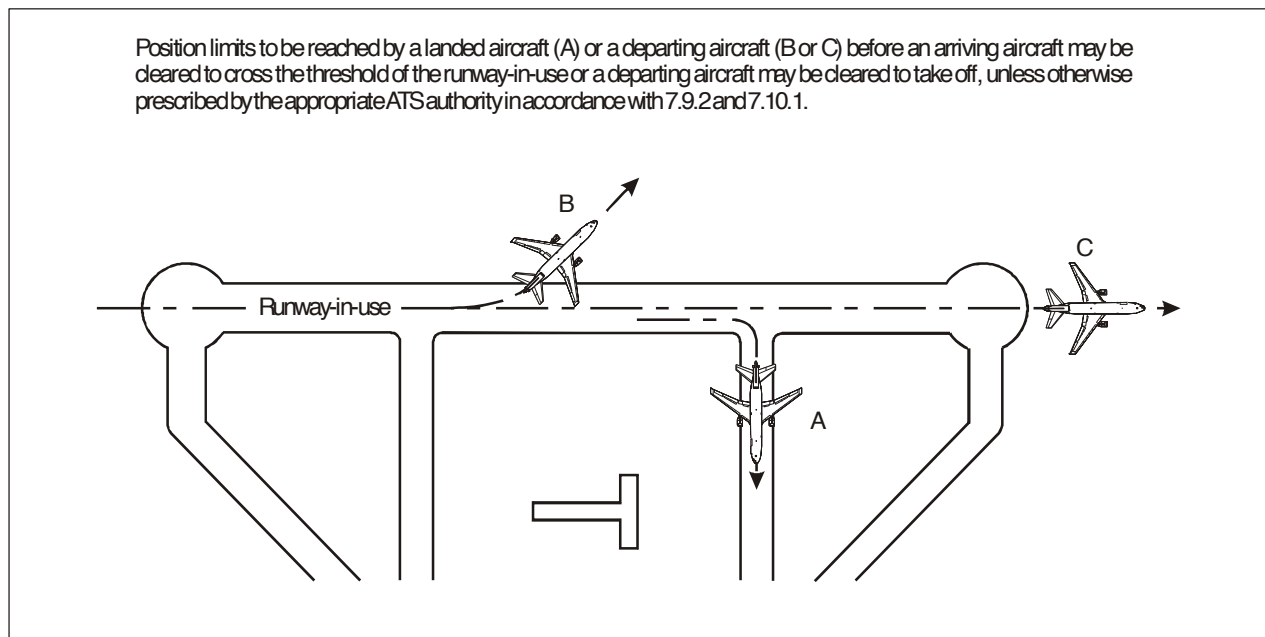

Figure 7-3. Separation between departing and arriving aircraft (see 7.9.2 and 7.10.1)

7.9.3 Take-off clearance

7.9.3.1 Take-off clearance may be issued to an aircraft when there is reasonable assurance that the separation in 7.9.2, or prescribed in accordance with 7.11, will exist when the aircraft commences take-off.

7.9.3.2 When an ATC clearance is required prior to take-off, the take-off clearance shall not be issued until the ATC clearance has been transmitted to and acknowledged by the aircraft concerned. The ATC clearance shall be forwarded to the aerodrome control tower with the least possible delay after receipt of a request made by the tower or prior to such request if practicable.

7.9.3.3 The expression TAKE-OFF shall only be used in radiotelephony when an aircraft is cleared for take-off or when cancelling a take-off clearance.

Note.— The expression TORA, pronounced TOR-AH, may be used to indicate take-off run available.

7.9.3.4 Subject to 7.9.3.2, the take-off clearance shall be issued when the aircraft is ready for take-off and at or approaching the departure runway, and the traffic situation permits. To reduce the potential for misunderstanding, the take-off clearance shall include the designator of the departure runway.

7.9.3.5 In the interest of expediting traffic, a clearance for immediate take-off may be issued to an aircraft before it enters the runway. On acceptance of such clearance the aircraft shall taxi out to the runway and take off in one continuous movement.

7.10 CONTROL OF ARRIVING AIRCRAFT

7.10.1 Separation of landing aircraft and preceding landing and departing aircraft using the same runway

Except as provided in 7.11 and Chapter 5, Section 5.8, a landing aircraft will not normally be permitted to cross the runway threshold on its final approach until the preceding departing aircraft has crossed the end of the runway-in-use, or has started a turn, or until all preceding landing aircraft are clear of the runway-in-use.

Note 1.— See Figure 7-3.

Note 2.— Wake turbulence categories of aircraft and longitudinal separation minima are contained in Chapter 4, Section 4.9 and Chapter 5, Section 5.8, respectively.

Note 3.— See 7.6.3.1.2.2.

7.10.2 Clearance to land

An aircraft may be cleared to land when there is reasonable assurance that the separation in 7.10.1, or prescribed in accordance with 7.11 will exist when the aircraft crosses the runway threshold, provided that a clearance to land shall not be issued until a preceding landing aircraft has crossed the runway threshold. To reduce the potential for misunderstanding, the landing clearance shall include the designator of the landing runway.

7.10.3 Landing and roll-out manoeuvres

7.10.3.1 When necessary or desirable in order to expedite traffic, a landing aircraft may be requested to:

- a) hold short of an intersecting runway after landing;
- b) land beyond the touchdown zone of the runway;
- c) vacate the runway at a specified exit taxiway;
- d) expedite vacating the runway.

7.10.3.2 In requesting a landing aircraft to perform a specific landing and/or roll-out manoeuvre, the type of aircraft, runway length, location of exit taxiways, reported braking action on runway and taxiway, and prevailing meteorological conditions shall be considered. A HEAVY aircraft shall not be requested to land beyond the touchdown zone of a runway.

7.10.3.3 If the pilot-in-command considers that he or she is unable to comply with the requested operation, the controller shall be advised without delay.

7.10.3.4 When necessary or desirable, e.g. due to low visibility conditions, a landing or a taxiing aircraft may be instructed to report when a runway has been vacated. The report shall be made when the entire aircraft is beyond the relevant runway-holding position.

7.11 REDUCED RUNWAY SEPARATION MINIMA BETWEEN AIRCRAFT USING THE SAME RUNWAY

7.11.1 Provided that an appropriate, documented safety assessment has shown that an acceptable level of safety can be met, lower minima than those in 7.9.2 and 7.10.1 may be prescribed by the appropriate ATS authority, after consultation with the operators. The safety assessment shall be carried out for each runway for which the reduced minima are intended, taking into account factors such as:

- a) runway length;
- b) aerodrome layout; and
- c) types/categories of aircraft involved.

7.11.2 All applicable procedures related to the application of reduced runway separation minima shall be published in the Aeronautical Information Publication as well as in local air traffic control instructions. Controllers shall be provided with appropriate and adequate training in the use of the procedures.

7.11.3 Reduced runway separation minima shall only be applied during the hours of daylight from 30 minutes after local sunrise to 30 minutes before local sunset.

7.11.4 For the purpose of reduced runway separation, aircraft shall be classified as follows:

- a) *Category 1 aircraft*: single-engine propeller aircraft with a maximum certificated take-off mass of 2 000 kg or less;

- b) *Category 2 aircraft*: single-engine propeller aircraft with a maximum certificated take-off mass of more than 2 000 kg but less than 7 000 kg; and twin-engine propeller aircraft with a maximum certificated take-off mass of less than 7 000 kg;
- c) *Category 3 aircraft*: all other aircraft.

7.11.5 Reduced runway separation minima shall not apply between a departing aircraft and a preceding landing aircraft.

7.11.6 Reduced runway separation minima shall be subject to the following conditions:

- a) wake turbulence separation minima shall be applied;
- b) visibility shall be at least 5 km and ceiling shall not be lower than 300 m (1 000 ft);
- c) tailwind component shall not exceed 5 kt;
- d) there shall be available means, such as suitable landmarks, to assist the controller in assessing the distances between aircraft. A surface surveillance system that provides the air traffic controller with position information on aircraft may be utilized, provided that approval for operational use of such equipment includes a safety assessment to ensure that all requisite operational and performance requirements are met;
- e) minimum separation continues to exist between two departing aircraft immediately after take-off of the second aircraft;
- f) traffic information shall be provided to the flight crew of the succeeding aircraft concerned; and
- g) the braking action shall not be adversely affected by runway contaminants such as ice, slush, snow and water.

7.11.7 Reduced runway separation minima which may be applied at an aerodrome shall be determined for each separate runway. The separation to be applied shall in no case be less than the following minima:

- a) landing aircraft:
 - 1) a succeeding landing Category 1 aircraft may cross the runway threshold when the preceding aircraft is a Category 1 or 2 aircraft which either:
 - i) has landed and has passed a point at least 600 m from the threshold of the runway, is in motion and will vacate the runway without backtracking; or
 - ii) is airborne and has passed a point at least 600 m from the threshold of the runway;
 - 2) a succeeding landing Category 2 aircraft may cross the runway threshold when the preceding aircraft is a Category 1 or 2 aircraft which either:
 - i) has landed and has passed a point at least 1 500 m from the threshold of the runway, is in motion and will vacate the runway without backtracking; or
 - ii) is airborne and has passed a point at least 1 500 m from the threshold of the runway;
 - 3) a succeeding landing aircraft may cross the runway threshold when a preceding Category 3 aircraft:

- i) has landed and has passed a point at least 2 400 m from the threshold of the runway, is in motion and will vacate the runway without backtracking; or
 - ii) is airborne and has passed a point at least 2 400 m from the threshold of the runway;
- b) departing aircraft:
- 1) a Category 1 aircraft may be cleared for take-off when the preceding departing aircraft is a Category 1 or 2 aircraft which is airborne and has passed a point at least 600 m from the position of the succeeding aircraft;
 - 2) a Category 2 aircraft may be cleared for take-off when the preceding departing aircraft is a Category 1 or 2 aircraft which is airborne and has passed a point at least 1 500 m from the position of the succeeding aircraft; and
 - 3) an aircraft may be cleared for take-off when a preceding departing Category 3 aircraft is airborne and has passed a point at least 2 400 m from the position of the succeeding aircraft.

7.11.7.1 Consideration should be given to increased separation between high performance single-engine aircraft and preceding Category 1 or 2 aircraft.

7.12 PROCEDURES FOR LOW VISIBILITY OPERATIONS

7.12.1 Control of aerodrome surface traffic in conditions of low visibility

Note.— These procedures apply whenever conditions are such that all or part of the manoeuvring area cannot be visually monitored from the control tower. Additional requirements which apply when category II/III approaches are being conducted are specified in Section 7.12.2.

7.12.1.1 When there is a requirement for traffic to operate on the manoeuvring area in conditions of visibility which prevent the aerodrome control tower from applying visual separation between aircraft, and between aircraft and vehicles, the following shall apply:

7.12.1.1.1 At the intersection of taxiways, an aircraft or vehicle on a taxiway shall not be permitted to hold closer to the other taxiway than the holding position limit defined by a clearance bar, stop bar or taxiway intersection marking according to the specifications in Annex 14, Volume I, Chapter 5.

7.12.1.1.2 The longitudinal separation on taxiways shall be as specified for each particular aerodrome by the appropriate ATS authority. This separation shall take into account the characteristics of the aids available for surveillance and control of ground traffic, the complexity of the aerodrome layout and the characteristics of the aircraft using the aerodrome.

Note.— The Manual of Surface Movement Guidance and Control Systems (SMGCS) (Doc 9476) provides guidance on surface movement guidance and control components and procedures for low visibility operations.

7.12.2 Procedures for control of aerodrome traffic when category II/III approaches are in use

7.12.2.1 The appropriate ATS authority shall establish provisions applicable to the start and continuation of precision approach category II/III operations as well as departure operations in RVR conditions less than a value of 550 m.

7.12.3 Low visibility operations shall be initiated by or through the aerodrome control tower.

7.12.4 The aerodrome control tower shall inform the approach control unit concerned when procedures for precision approach category II/III and low visibility operations will be applied and also when such procedures are no longer in force.

7.12.5 Provisions regarding low visibility operations should specify:

- a) the RVR value(s) at which the low visibility operations procedures shall be implemented;
- b) the minimum ILS/MLS equipment requirements for category II/III operations;
- c) other facilities and aids required for category II/III operations, including aeronautical ground lights, which shall be monitored for normal operation;
- d) the criteria for and the circumstances under which downgrading of the ILS/MLS equipment from category II/III operations capability shall be made;
- e) the requirement to report any relevant equipment failure and degradation, without delay, to the flight crews concerned, the approach control unit, and any other appropriate organization;
- f) special procedures for the control of traffic on the manoeuvring area, including:
 - 1) the runway-holding positions to be used;
 - 2) the minimum distance between an arriving and a departing aircraft to ensure protection of the sensitive and critical areas;
 - 3) procedures to verify that aircraft and vehicles have vacated the runway;
 - 4) procedures applicable to the separation of aircraft and vehicles;
- g) applicable spacing between successive approaching aircraft;
- h) action(s) to be taken in the event low visibility operations need to be discontinued, e.g. due to equipment failures; and
- i) any other relevant procedures or requirements.

Note.— Further information regarding the requirements for low visibility operations can be found in the Air Traffic Services Planning Manual (Doc 9426) and the All-Weather Operations Manual (Doc 9365).

7.12.6 The aerodrome control tower shall, prior to a period of application of low visibility procedures, establish a record of vehicles and persons currently on the manoeuvring area and maintain this record during the period of application of these procedures to assist in assuring the safety of operations on that area.

Note.— See also 7.6.3.2.

7.13 SUSPENSION OF VISUAL FLIGHT RULES OPERATIONS

7.13.1 Any or all VFR operations on and in the vicinity of an aerodrome may be suspended by any of the following units, persons or authorities whenever safety requires such action:

- a) the approach control unit or the appropriate ACC;
- b) the aerodrome control tower;
- c) the appropriate ATS authority.

7.13.2 All such suspensions of VFR operations shall be accomplished through or notified to the aerodrome control tower.

7.13.3 The following procedures shall be observed by the aerodrome control tower whenever VFR operations are suspended:

- a) hold all VFR departures;
- b) recall all local flights operating under VFR or obtain approval for special VFR operations;
- c) notify the approach control unit or ACC as appropriate of the action taken;
- d) notify all operators, or their designated representatives, of the reason for taking such action, if necessary or requested.

7.14 AUTHORIZATION OF SPECIAL VFR FLIGHTS

7.14.1 When traffic conditions permit, special VFR flights may be authorized subject to the approval of the unit providing approach control service and the provisions of 7.14.1.3.

7.14.1.1 Requests for such authorization shall be handled individually.

7.14.1.2 Separation shall be effected between all IFR flights and special VFR flights in accordance with separation minima in Chapters 5 and 6 and, when so prescribed by the appropriate ATS authority, between all special VFR flights in accordance with separation minima prescribed by that authority.

7.14.1.3 When the ground visibility is not less than 1 500 m, special VFR flights may be authorized to: enter a control zone for the purpose of landing, take off and depart from a control zone, cross a control zone or operate locally within a control zone.

Note.— Requirements for two-way communications between controlled flights and the appropriate air traffic control unit are contained in Annex 2, 3.6.5.

7.15 AERONAUTICAL GROUND LIGHTS

7.15.1 Operation

Note.— The procedures in this Section apply to all aerodromes, whether or not aerodrome control service is provided. In addition, the procedures in 7.15.2.1 apply to all aeronautical ground lights, whether or not they are on or in the vicinity of an aerodrome.

7.15.2 General

7.15.2.1 All aeronautical ground lights shall be operated, except as provided in 7.15.2.2 and 7.15.3:

- a) continuously during the hours of darkness or during the time the centre of the sun's disc is more than 6 degrees below the horizon, whichever requires the longer period of operation, unless otherwise provided hereafter or otherwise required for the control of air traffic;
- b) at any other time when their use, based on meteorological conditions, is considered desirable for the safety of air traffic.

7.15.2.2 Lights on and in the vicinity of aerodromes that are not intended for en-route navigation purposes may be turned off, subject to further provisions hereafter, if no likelihood of either regular or emergency operation exists, provided that they can be again brought into operation at least one hour before the expected arrival of an aircraft.

7.15.2.3 At aerodromes equipped with lights of variable intensity a table of intensity settings, based on conditions of visibility and ambient light, should be provided for the guidance of air traffic controllers in effecting adjustment of these lights to suit the prevailing conditions. When so requested by an aircraft, further adjustment of the intensity shall be made whenever possible.

7.15.3 Approach lighting

Note.— Approach lighting includes such lights as simple approach lighting systems, precision approach lighting systems, visual approach slope indicator systems, circling guidance lights, approach light beacons and runway alignment indicators.

7.15.3.1 In addition to 7.15.2.1 approach lighting shall also be operated:

- a) by day when requested by an approaching aircraft;
- b) when the associated runway lighting is operated.

7.15.3.2 The lights of a visual approach slope indicator system shall be operated during the hours of daylight as well as of darkness and irrespective of the visibility conditions when the associated runway is being used.

7.15.4 Runway lighting

Note.— Runway lighting includes such lights as edge, threshold, centre line, end, touchdown zone and wing bar lights.

7.15.4.1 Runway lighting shall not be operated if that runway is not in use for landing, take-off or taxiing purposes, unless required for runway inspections or maintenance.

7.15.4.2 If runway lighting is not operated continuously, lighting following a take-off shall be provided as specified below:

- a) at aerodromes where air traffic control service is provided and where lights are centrally controlled, the lights of one runway shall remain lighted after take-off as long as is considered necessary for the return of the aircraft due to an emergency occurring during or immediately after take-off;

- b) at aerodromes without air traffic control service or without centrally controlled lights, the lights of one runway shall remain lighted until such time as would normally be required to reactivate the lights in the likelihood of the departing aircraft returning for an emergency landing, and in any case not less than fifteen minutes after take-off.

Note.— Where obstacle lighting is operated simultaneously with runway lighting as provided in 7.15.8.1, particular care should be taken to ensure that it is not turned off until no longer required by the aircraft.

7.15.5 Stopway lighting

Stopway lights shall be operated whenever the associated runway lights are operated.

7.15.6 Taxiway lighting

Note.— Taxiway lighting includes such lights as edge lights, centre line lights, stop bars and clearance bars.

Where required to provide taxi guidance, taxiway lighting shall be turned on in such order that a continuous indication of the taxi path is presented to taxiing aircraft. Taxiway lighting or any portion thereof may be turned off when no longer needed.

7.15.7 Stop bars

Stop bars shall be switched on to indicate that all traffic shall stop and switched off to indicate that traffic may proceed.

Note.— Stop bars are located across taxiways at the point where it is desired that traffic stop, and consist of lights, showing red, spaced across the taxiway.

7.15.8 Obstacle lighting

Note.— Obstacle lighting includes such lights as obstacle and unserviceability lights and hazard beacons.

7.15.8.1 Obstacle lighting associated with the approach to or departure from a runway or channel, where the obstacle does not project through the inner horizontal surface, as described in Annex 14, Volume I, Chapter 6, may be turned off and on simultaneously with the runway or channel lights.

7.15.8.2 Unserviceability lights may not be turned off as permitted under 7.15.2.2 while the aerodrome is open.

7.15.9 Monitoring of visual aids

7.15.9.1 Aerodrome controllers shall make use of automatic monitoring facilities, when provided, to ascertain whether the lighting is in good order and functioning according to selection.

7.15.9.2 In the absence of an automatic monitoring system or to supplement such a system, the aerodrome controller shall visually observe such lighting as can be seen from the aerodrome control tower and use information from other sources such as visual inspections or reports from aircraft to maintain awareness of the operational status of the visual aids.

7.15.9.3 On receipt of information indicating a lighting fault, the aerodrome controller shall take such action as is warranted to safeguard any affected aircraft or vehicles, and initiate action to have the fault rectified.

7.16 DESIGNATION OF HOT SPOT(S)

The aerodrome operator shall designate, whenever necessary, a location or several locations on the movement area of the aerodrome as hot spot(s). The hot spot(s) shall be charted in accordance with Annex 4, 13.6, 14.6, 15.6 and Appendix 2.

Note.— Guidance material related to hot spots is contained in the Manual on the Prevention of Runway Incursions (Doc 9870).

Chapter 8

ATS SURVEILLANCE SERVICES

Note.— *ADS-contract (ADS-C), at this time used wholly to provide procedural separation, is covered in Chapter 13.*

8.1 ATS SURVEILLANCE SYSTEMS CAPABILITIES

8.1.1 ATS surveillance systems used in the provision of air traffic services shall have a very high level of reliability, availability and integrity. The possibility of system failures or significant system degradations which may cause complete or partial interruptions of service shall be very remote. Backup facilities shall be provided.

Note 1.— *An ATS surveillance system will normally consist of a number of integrated elements, including sensor(s), data transmission links, data-processing systems and situation displays.*

Note 2.— *Guidance material pertaining to use of radar and to system performance is contained in the Manual on Testing of Radio Navigation Aids (Doc 8071), the Manual on the Secondary Surveillance Radar (SSR) Systems (Doc 9684) and the Air Traffic Services Planning Manual (Doc 9426).*

Note 3.— *Guidance material pertaining to use of ADS-B and MLAT systems and their system performance is contained in Cir 326.*

Note 4.— *Functional and performance requirements pertaining to ATS surveillance systems are contained in Annex 10 — Aeronautical Telecommunications, Volume IV — Surveillance and Collision Avoidance Systems.*

8.1.2 ATS surveillance systems should have the capability to receive, process and display, in an integrated manner, data from all the connected sources.

8.1.3 ATS surveillance systems should be capable of integration with other automated systems used in the provision of ATS, and should provide for an appropriate level of automation with the objectives of improving the accuracy and timeliness of data displayed to the controller and reducing controller workload and the need for verbal coordination between adjacent control positions and ATC units.

8.1.4 ATS surveillance systems should provide for the display of safety-related alerts and warnings, including conflict alert, minimum safe altitude warning, conflict prediction and unintentionally duplicated SSR codes and aircraft identification.

8.1.5 States should, to the extent possible, facilitate the sharing of information derived from ATS surveillance systems in order to extend and improve surveillance coverage in adjacent control areas.

8.1.6 States should, on the basis of regional air navigation agreements, provide for the automated exchange of coordination data relevant to aircraft being provided with ATS surveillance services, and establish automated coordination procedures.

8.1.7 ATS surveillance systems, such as primary surveillance radar (PSR), secondary surveillance radar (SSR), ADS-B and MLAT systems may be used either alone or in combination in the provision of air traffic services, including in the provision of separation between aircraft, provided:

- a) reliable coverage exists in the area;
- b) the probability of detection, the accuracy and the integrity of the ATS surveillance system(s) are satisfactory; and
- c) in the case of ADS-B, the availability of data from participating aircraft is adequate.

8.1.8 PSR systems should be used in circumstances where other ATS surveillance systems alone would not meet the air traffic services requirements.

8.1.9 SSR systems, especially those utilizing monopulse techniques or having Mode S capability or MLAT, may be used alone, including in the provision of separation between aircraft, provided:

- a) the carriage of SSR transponders is mandatory within the area; and
- b) identification is established and maintained.

8.1.10 ADS-B shall only be used for the provision of air traffic control service provided the quality of the information contained in the ADS-B message exceeds the values specified by the appropriate ATS authority.

8.1.11 ADS-B may be used alone, including in the provision of separation between aircraft, provided:

- a) identification of ADS-B-equipped aircraft is established and maintained;
- b) the data integrity measure in the ADS-B message is adequate to support the separation minimum;
- c) there is no requirement for detection of aircraft not transmitting ADS-B; and
- d) there is no requirement for determination of aircraft position independent of the position-determining elements of the aircraft navigation system.

8.1.12 The provision of ATS surveillance services shall be limited to specified areas of coverage and shall be subject to such other limitations as have been specified by the appropriate ATS authority. Adequate information on the operating methods used shall be published in aeronautical information publications, as well as operating practices and/or equipment limitations having direct effects on the operation of the air traffic services.

Note.— States will provide information on the area or areas where PSR, SSR, ADS-B and MLAT systems are in use as well as ATS surveillance services and procedures in accordance with Annex 15, 4.1.1 and Appendix 1.

8.1.12.1 The provision of ATS surveillance services shall be limited when position data quality degrades below a level specified by the appropriate ATS authority.

8.1.13 Where PSR and SSR are required to be used in combination, SSR alone may be used in the event of PSR failure to provide separation between identified transponder-equipped aircraft, provided the accuracy of the SSR position indications has been verified by monitor equipment or other means.

8.2 SITUATION DISPLAY

8.2.1 A situation display providing surveillance information to the controller shall, as a minimum, include position indications, map information required to provide ATS surveillance services and, where available, information concerning the identity of the aircraft and the aircraft level.

8.2.2 The ATS surveillance system shall provide for a continuously updated presentation of surveillance information, including position indications.

8.2.3 Position indications may be displayed as:

- a) individual position symbols, e.g. PSR, SSR, ADS-B or MLAT symbols, or combined symbols;
- b) PSR blips; and
- c) SSR responses.

8.2.4 When applicable, distinct symbols should be used for presentation of:

- a) unintentionally duplicated SSR codes and/or aircraft identification that are unintentionally duplicated;
- b) predicted positions for a non-updated track; and
- c) plot and track data.

8.2.5 Where surveillance data quality degrades such that services need to be limited, symbology or other means shall be used to provide the controller with an indication of the condition.

8.2.6 Reserved SSR codes, including 7500, 7600 and 7700, operation of IDENT, ADS-B emergency and/or urgency modes, safety-related alerts and warnings as well as information related to automated coordination shall be presented in a clear and distinct manner, providing for ease of recognition.

8.2.7 Labels associated with displayed targets should be used to provide, in alphanumeric form, relevant information derived from the means of surveillance and, where necessary, the flight data processing system.

8.2.8 Labels shall, as a minimum, include information relating to the identity of the aircraft, e.g. SSR code or aircraft identification and, if available, pressure-altitude-derived level information. This information may be obtained from SSR Mode A, SSR Mode C, SSR Mode S and/or ADS-B.

8.2.9 Labels shall be associated with their position indications in a manner precluding erroneous identification by or confusion on the part of the controller. All label information shall be presented in a clear and concise manner.

8.3 COMMUNICATIONS

8.3.1 The level of reliability and availability of communications systems shall be such that the possibility of system failures or significant degradations is very remote. Adequate backup facilities shall be provided.

Note.— Guidance material and information pertaining to system reliability and availability are contained in Annex 10, Volume I, and the Air Traffic Services Planning Manual (Doc 9426).

8.3.2 Direct pilot-controller communications shall be established prior to the provision of ATS surveillance services, unless special circumstances, such as emergencies, dictate otherwise.

8.4 PROVISION OF ATS SURVEILLANCE SERVICES

8.4.1 Information derived from ATS surveillance systems, including safety-related alerts and warnings such as conflict alert and minimum safe altitude warning, should be used to the extent possible in the provision of air traffic control service in order to improve capacity and efficiency as well as to enhance safety.

8.4.2 The number of aircraft simultaneously provided with ATS surveillance services shall not exceed that which can safely be handled under the prevailing circumstances, taking into account:

- a) the structural complexity of the control area or sector concerned;
- b) the functions to be performed within the control area or sector concerned;
- c) assessments of controller workloads, taking into account different aircraft capabilities, and sector capacity; and
- d) the degree of technical reliability and availability of the primary and backup communications, navigation and surveillance systems, both in the aircraft and on the ground.

8.5 USE OF SSR TRANSPONDERS AND ADS-B TRANSMITTERS

8.5.1 General

To ensure the safe and efficient use of ATS surveillance services, pilots and controllers shall strictly adhere to published operating procedures and standard radiotelephony phraseology shall be used. The correct setting of transponder codes and/or aircraft identification shall be ensured at all times.

8.5.2 SSR code management

8.5.2.1 Codes 7700, 7600 and 7500 shall be reserved internationally for use by pilots encountering a state of emergency, radiocommunication failure or unlawful interference, respectively.

8.5.2.2 SSR codes are to be allocated and assigned in accordance with the following principles.

8.5.2.2.1 Codes should be allocated to States or areas in accordance with regional air navigation agreements, taking into account overlapping radar coverage over adjacent airspaces.

8.5.2.2.2 The appropriate ATS authority shall establish a plan and procedures for the allocation of codes to ATS units.

8.5.2.2.3 The plan and procedures should be compatible with those practised in adjacent States.

8.5.2.2.4 The allocation of a code should preclude the use of this code for any other function within the area of coverage of the same SSR for a prescribed time period.

8.5.2.2.5 To reduce pilot and controller workload and the need for controller/pilot communications, the number of code changes required of the pilot should be kept to the minimum.

8.5.2.2.6 Codes shall be assigned to aircraft in accordance with the plan and procedures laid down by the appropriate ATS authority.

8.5.2.2.7 Where there is a need for individual aircraft identification, each aircraft shall be assigned a discrete code which should, whenever possible, be retained throughout the flight.

8.5.2.2.8 Except for aircraft in a state of emergency, or during communication failure or unlawful interference situations, and unless otherwise agreed by regional air navigation agreement or between a transferring and an accepting ATC unit, the transferring unit shall assign Code A2000 to a controlled flight prior to transfer of communications.

8.5.2.3 SSR codes shall be reserved, as necessary, for exclusive use by medical aircraft operating in areas of international armed conflict. SSR codes shall be allocated by ICAO through its Regional Offices in coordination with States concerned and should be assigned to aircraft for use within the area of conflict.

Note.— The term “medical aircraft” refers to aircraft protected under the Geneva Conventions of 1949 and under the Protocol Additional to the Geneva Conventions of 12 August 1949, and relating to the protection of victims of international armed conflicts (Protocol I).

8.5.3 Operation of SSR transponders

Note.— SSR transponder operating procedures are contained in Procedures for Air Navigation Services — Aircraft Operations (PANS-OPS, Doc 8168), Volume I, Part III, Section 3.

8.5.3.1 When it is observed that the Mode A code shown on the situation display is different to what has been assigned to the aircraft, the pilot shall be requested to confirm the code selected and, if the situation warrants (e.g. not being a case of unlawful interference), to reselect the correct code.

8.5.3.2 If the discrepancy between assigned and displayed Mode A codes still persists, the pilot may be requested to stop the operation of the aircraft’s transponder. The next control position and any other affected unit using SSR and/or MLAT in the provision of ATS shall be informed accordingly.

8.5.3.3 Aircraft equipped with Mode S having an aircraft identification feature shall transmit the aircraft identification as specified in Item 7 of the ICAO flight plan or, when no flight plan has been filed, the aircraft registration.

Note.— All Mode S-equipped aircraft engaged in international civil aviation are required to have an aircraft identification feature (Annex 10, Volume IV, Chapter 2, 2.1.5.2, refers).

8.5.3.4 Whenever it is observed on the situation display that the aircraft identification transmitted by a Mode S-equipped aircraft is different from that expected from the aircraft, the pilot shall be requested to confirm and, if necessary, re-enter the correct aircraft identification.

8.5.3.5 If, following confirmation by the pilot that the correct aircraft identification has been set on the Mode S identification feature, the discrepancy continues to exist, the following actions shall be taken by the controller:

- a) inform the pilot of the persistent discrepancy;
- b) where possible, correct the label showing the aircraft identification on the situation display; and

- c) notify the erroneous aircraft identification transmitted by the aircraft to the next control position and any other interested unit using Mode S for identification purposes.

8.5.4 Operation of ADS-B transmitters

Note 1.— To indicate that it is in a state of emergency or to transmit other urgent information, an aircraft equipped with ADS-B might operate the emergency and/or urgency mode as follows:

- a) *emergency;*
- b) *communication failure;*
- c) *unlawful interference;*
- d) *minimum fuel; and/or*
- e) *medical.*

Note 2.— Some aircraft equipped with first generation ADS-B avionics do not have the capability described in Note 1 above and only have the capability to transmit a general emergency alert regardless of the code selected by the pilot.

8.5.4.1 Aircraft equipped with ADS-B having an aircraft identification feature shall transmit the aircraft identification as specified in Item 7 of the ICAO flight plan or, when no flight plan has been filed, the aircraft registration.

8.5.4.2 Whenever it is observed on the situation display that the aircraft identification transmitted by an ADS-B-equipped aircraft is different from that expected from the aircraft, the pilot shall be requested to confirm and, if necessary, re-enter the correct aircraft identification.

8.5.4.3 If, following confirmation by the pilot that the correct aircraft identification has been set on the ADS-B identification feature, the discrepancy continues to exist, the following actions shall be taken by the controller:

- a) inform the pilot of the persistent discrepancy;
- b) where possible, correct the label showing the aircraft identification on the situation display; and
- c) notify the next control position and any other unit concerned of the erroneous aircraft identification transmitted by the aircraft.

8.5.5 Level information based on the use of pressure-altitude information

8.5.5.1 VERIFICATION OF LEVEL INFORMATION

8.5.5.1.1 The tolerance value used to determine that pressure-altitude-derived level information displayed to the controller is accurate shall be ± 60 m (± 200 ft) in RVSM airspace. In other airspace, it shall be ± 90 m (± 300 ft), except that the appropriate ATS authority may specify a smaller criterion, but not less than ± 60 m (± 200 ft), if this is found to be more practical. Geometric height information shall not be used for separation.

8.5.5.1.2 Verification of pressure-altitude-derived level information displayed to the controller shall be effected at least once by each suitably equipped ATC unit on initial contact with the aircraft concerned or, if this is not feasible, as soon as possible thereafter. The verification shall be effected by simultaneous comparison with altimeter-derived level information received from the same aircraft by radiotelephony. The pilot of the aircraft whose pressure-altitude-derived level information is within the approved tolerance value need not be advised of such verification. Geometric height information shall not be used to determine if altitude differences exist.

8.5.5.1.3 If the displayed level information is not within the approved tolerance value or when a discrepancy in excess of the approved tolerance value is detected subsequent to verification, the pilot shall be advised accordingly and requested to check the pressure setting and confirm the aircraft's level.

8.5.5.1.4 If, following confirmation of the correct pressure setting the discrepancy continues to exist, the following action should be taken according to circumstances:

- a) request the pilot to stop Mode C or ADS-B altitude data transmission, provided this does not cause the loss of position and identity information, and notify the next control positions or ATC unit concerned with the aircraft of the action taken; or
- b) inform the pilot of the discrepancy and request that the relevant operation continue in order to prevent loss of position and identity information of the aircraft and, when authorized by the appropriate ATS authority, override the label-displayed level information with the reported level. Notify the next control position or ATC unit concerned with the aircraft of the action taken.

8.5.5.2 DETERMINATION OF LEVEL OCCUPANCY

8.5.5.2.1 The criterion which shall be used to determine that a specific level is occupied by an aircraft shall be ± 60 m (± 200 ft) in RVSM airspace. In other airspace, it shall be ± 90 m (± 300 ft), except that the appropriate ATS authority may specify a smaller criterion, but not less than ± 60 m (± 200 ft), if this is found to be more practical.

Note.— For a brief explanation of the considerations underlying this value, see the Air Traffic Services Planning Manual (Doc 9426).

8.5.5.2.2 *Aircraft maintaining a level.* An aircraft is considered to be maintaining its assigned level as long as the pressure-altitude-derived level information indicates that it is within the appropriate tolerances of the assigned level, as specified in 8.5.5.2.1.

8.5.5.2.3 *Aircraft vacating a level.* An aircraft cleared to leave a level is considered to have commenced its manoeuvre and vacated the previously occupied level when the pressure-altitude-derived level information indicates a change of more than 90 m (300 ft) in the anticipated direction from its previously assigned level.

8.5.5.2.4 *Aircraft passing a level in climb or descent.* An aircraft in climb or descent is considered to have crossed a level when the pressure-altitude-derived level information indicates that it has passed this level in the required direction by more than 90 m (300 ft).

8.5.5.2.5 *Aircraft reaching a level.* An aircraft is considered to have reached the level to which it has been cleared when the elapsed time of three display updates, three sensor updates or 15 seconds, whichever is the greater, has passed since the pressure-altitude-derived level information has indicated that it is within the appropriate tolerances of the assigned level, as specified in 8.5.5.2.1.

8.5.5.2.6 Intervention by a controller shall only be required if differences in level information between that displayed to the controller and that used for control purposes are in excess of the values stated above.

8.6 GENERAL PROCEDURES

8.6.1 Performance checks

8.6.1.1 The controller shall adjust the situation display(s) and carry out adequate checks on the accuracy thereof, in accordance with the technical instructions prescribed by the appropriate authority for the equipment concerned.

8.6.1.2 The controller shall be satisfied that the available functional capabilities of the ATS surveillance system as well as the information presented on the situation display(s) is adequate for the functions to be performed.

8.6.1.3 The controller shall report, in accordance with local procedures, any fault in the equipment, or any incident requiring investigation, or any circumstances which make it difficult or impractical to provide ATS surveillance services.

8.6.2 Identification of aircraft

8.6.2.1 ESTABLISHMENT OF IDENTIFICATION

8.6.2.1.1 Before providing an ATS surveillance service to an aircraft, identification shall be established and the pilot informed. Thereafter, identification shall be maintained until termination of the ATS surveillance service.

8.6.2.1.2 If identification is subsequently lost, the pilot shall be informed accordingly and, when applicable, appropriate instructions issued.

8.6.2.1.3 Identification shall be established by at least one of the methods specified in 8.6.2.2, 8.6.2.3, 8.6.2.4 and 8.6.2.5.

8.6.2.2 ADS-B IDENTIFICATION PROCEDURES

Where ADS-B is used for identification, aircraft may be identified by one or more of the following procedures:

- a) direct recognition of the aircraft identification in an ADS-B label;
- b) transfer of ADS-B identification (see 8.6.3); and
- c) observation of compliance with an instruction to TRANSMIT ADS-B IDENT.

Note 1.— Some aircraft equipped with first generation ADS-B avionics do not have the capability of squawking IDENT while the emergency and/or urgency mode is selected.

Note 2.— In automated systems, the “IDENT” feature may be presented in different ways, e.g. as a flashing of all or part of the position indication and associated label.

8.6.2.3 SSR and/or MLAT IDENTIFICATION PROCEDURES

8.6.2.3.1 Where SSR and/or MLAT is used for identification, aircraft may be identified by one or more of the following procedures:

- a) recognition of the aircraft identification in an SSR and/or MLAT label;

Note.— The use of this procedure requires that the code/call sign correlation is achieved successfully, taking into account the Note following b) below.

- b) recognition of an assigned discrete code, the setting of which has been verified, in an SSR and/or MLAT label; and

Note.— The use of this procedure requires a system of code assignment which ensures that each aircraft in a given portion of airspace is assigned a discrete code (see 8.5.2.2.7).

- c) direct recognition of the aircraft identification of a Mode S-equipped aircraft in an SSR and/or MLAT label;

Note.— The aircraft identification feature available in Mode S transponders provides the means to identify directly individual aircraft on situation displays and thus offers the potential to eliminate ultimately the recourse to Mode A discrete codes for individual identification. This elimination will only be achieved in a progressive manner depending on the state of deployment of suitable ground and airborne installations.

- d) by transfer of identification (see 8.6.3);
- e) observation of compliance with an instruction to set a specific code;
- f) observation of compliance with an instruction to squawk IDENT.

Note 1.— In automated radar systems, the “IDENT” feature may be presented in different ways, e.g. as a flashing of all or part of the position indication and associated label.

Note 2.— Garbling of transponder replies may produce “IDENT”-type of indications. Nearly simultaneous “IDENT” transmissions within the same area may give rise to errors in identification.

8.6.2.3.2 When a discrete code has been assigned to an aircraft, a check shall be made at the earliest opportunity to ensure that the code set by the pilot is identical to that assigned for the flight. Only after this check has been made shall the discrete code be used as a basis for identification.

8.6.2.4 PSR IDENTIFICATION PROCEDURES

8.6.2.4.1 Where PSR is used for identification, aircraft may be identified by one or more of the following procedures:

- a) by correlating a particular radar position indication with an aircraft reporting its position over, or as bearing and distance from, a point shown on the situation display, and by ascertaining that the track of the particular radar position is consistent with the aircraft path or reported heading;

Note 1.— Caution must be exercised when employing this method since a position reported in relation to a point may not coincide precisely with the radar position indication of the aircraft on the situation display. The appropriate ATS authority may, therefore, prescribe additional conditions for the application of this method, e.g.:

- i) a level or levels above which this method may not be applied in respect of specified navigation aids; or
- ii) a distance from the radar site beyond which this method may not be applied.

Note 2.— The term “a point” refers to a geographical point suitable for the purposes of identification. It is normally a reporting point defined by reference to a radio navigation aid or aids.

- b) by correlating an observed radar position indication with an aircraft which is known to have just departed, provided that the identification is established within 2 km (1 NM) from the end of the runway used. Particular care should be taken to avoid confusion with aircraft holding over or overflying the aerodrome, or with aircraft departing from or making a missed approach over adjacent runways;
- c) by transfer of identification (see 8.6.3);
- d) by ascertaining the aircraft heading, if circumstances require, and following a period of track observation:
 - instructing the pilot to execute one or more changes of heading of 30 degrees or more and correlating the movements of one particular radar position indication with the aircraft's acknowledged execution of the instructions given; or
 - correlating the movements of a particular radar position indication with manoeuvres currently executed by an aircraft having so reported.

When using these methods, the controller shall:

- i) verify that the movements of not more than one radar position indication correspond with those of the aircraft; and
- ii) ensure that the manoeuvre(s) will not carry the aircraft outside the coverage of the radar or the situation display.

Note 1.— Caution must be exercised when employing these methods in areas where route changes normally take place.

Note 2.— With reference to ii) above, see also 8.6.5.1 regarding vectoring of controlled aircraft.

8.6.2.4.2 Use may be made of direction-finding bearings to assist in identification of an aircraft. This method, however, shall not be used as the sole means of establishing identification, unless so prescribed by the appropriate ATS authority for particular cases under specified conditions.

8.6.2.5 ADDITIONAL IDENTIFICATION METHOD

When two or more position indications are observed in close proximity, or are observed to be making similar movements at the same time, or when doubt exists as to the identity of a position indication for any other reason, changes of heading should be prescribed or repeated as many times as necessary, or additional methods of identification should be employed, until all risk of error in identification is eliminated.

8.6.3 Transfer of identification

8.6.3.1 Transfer of identification from one controller to another should only be attempted when it is considered that the aircraft is within the accepting controller's surveillance coverage.

8.6.3.2 Transfer of identification shall be effected by one of the following methods:

- a) designation of the position indication by automated means, provided that only one position indication is thereby indicated and there is no possible doubt of correct identification;
- b) notification of the aircraft's discrete SSR code or aircraft address;

Note 1.— The use of a discrete SSR code requires a system of code assignment which ensures that each aircraft in a given portion of airspace is assigned a discrete code (see 8.5.2.2.7).

Note 2.— Aircraft address would be expressed in the form of the alphanumeric code of six hexadecimal characters.

- c) notification that the aircraft is SSR Mode S-equipped with an aircraft identification feature when SSR Mode S coverage is available;
- d) notification that the aircraft is ADS-B-equipped with an aircraft identification feature when compatible ADS-B coverage is available;
- e) direct designation (pointing with the finger) of the position indication, if the two situation displays are adjacent, or if a common “conference” type of situation display is used;

Note.— Attention must be given to any errors which might occur due to parallax effects.

- f) designation of the position indication by reference to, or in terms of bearing and distance from, a geographical position or navigational facility accurately indicated on both situation displays, together with the track of the observed position indication if the route of the aircraft is not known to both controllers;

Note.— Caution must be exercised before transferring identification using this method, particularly if other position indications are observed on similar headings and in close proximity to the aircraft under control. Inherent radar deficiencies, such as inaccuracies in bearing and distance of the radar position indications displayed on individual situation displays and parallax errors, may cause the indicated position of an aircraft in relation to the known point to differ between the two situation displays. The appropriate ATS authority may, therefore, prescribe additional conditions for the application of this method, e.g.:

- i) *a maximum distance from the common reference point used by the two controllers; and*
 - ii) *a maximum distance between the position indication as observed by the accepting controller and the one stated by the transferring controller.*
- g) where applicable, issuance of an instruction to the aircraft by the transferring controller to change SSR code and the observation of the change by the accepting controller; or
 - h) issuance of an instruction to the aircraft by the transferring controller to squawk/transmit IDENT and observation of this response by the accepting controller.

Note.— Use of procedures g) and h) requires prior coordination between the controllers, since the indications to be observed by the accepting controller are of short duration.

8.6.4 Position information

8.6.4.1 An aircraft provided with ATS surveillance service should be informed of its position in the following circumstances:

- a) upon identification, except when the identification is established:
 - i) based on the pilot’s report of the aircraft position or within one nautical mile of the runway upon departure and the observed position on the situation display is consistent with the aircraft’s time of departure; or

- ii) by use of ADS-B aircraft identification, Mode S aircraft identification or assigned discrete SSR codes and the location of the observed position indication is consistent with the current flight plan of the aircraft; or
- iii) by transfer of identification;
- b) when the pilot requests this information;
- c) when a pilot's estimate differs significantly from the controller's estimate based on the observed position;
- d) when the pilot is instructed to resume own navigation after vectoring if the current instructions had diverted the aircraft from a previously assigned route (see 8.6.5.5);
- e) immediately before termination of ATS surveillance service, if the aircraft is observed to deviate from its intended route.

8.6.4.2 Position information shall be passed to aircraft in one of the following forms:

- a) as a well-known geographical position;
- b) magnetic track and distance to a significant point, an en-route navigation aid, or an approach aid;
- c) direction (using points of the compass) and distance from a known position;
- d) distance to touchdown, if the aircraft is on final approach; or
- e) distance and direction from the centre line of an ATS route.

8.6.4.3 Whenever practicable, position information shall relate to positions or routes pertinent to the navigation of the aircraft concerned and shown on the situation display map.

8.6.4.4 When so informed, the pilot may omit position reports at compulsory reporting points or report only over those reporting points specified by the air traffic services unit concerned. Unless automated position reporting is in effect (e.g. ADS-C), pilots shall resume voice or CPDLC position reporting:

- a) when so instructed;
- b) when advised that the ATS surveillance service has been terminated; or
- c) when advised that identification is lost.

8.6.5 Vectoring

8.6.5.1 Vectoring shall be achieved by issuing to the pilot specific headings which will enable the aircraft to maintain the desired track. When vectoring an aircraft, a controller shall comply with the following:

- a) whenever practicable, the aircraft shall be vectored along tracks on which the pilot can monitor the aircraft position with reference to pilot-interpreted navigation aids (this will minimize the amount of navigational assistance required and alleviate the consequences resulting from an ATS surveillance system failure);
- b) when an aircraft is given its initial vector diverting it from a previously assigned route, the pilot shall be informed what the vector is to accomplish, and the limit of the vector shall be specified (e.g. to ... position, for ... approach);

- c) except when transfer of control is to be effected, aircraft shall not be vectored closer than 4.6 km (2.5 NM) or, where the minimum permissible separation is greater than 9.3 km (5 NM), a distance equivalent to one-half of the prescribed separation minimum, from the limit of the airspace for which the controller is responsible, unless local arrangements have been made to ensure that separation will exist with aircraft operating in adjoining areas;
- d) controlled flights shall not be vectored into uncontrolled airspace except in the case of emergency or in order to circumnavigate adverse meteorological conditions (in which case the pilot should be so informed), or at the specific request of the pilot; and
- e) when an aircraft has reported unreliable directional instruments, the pilot shall be requested, prior to the issuance of manoeuvring instructions, to make all turns at an agreed rate and to carry out the instructions immediately upon receipt.

8.6.5.2 When vectoring an IFR flight and when giving an IFR flight a direct routing which takes the aircraft off an ATS route, the controller shall issue clearances such that the prescribed obstacle clearance will exist at all times until the aircraft reaches the point where the pilot will resume own navigation. When necessary, the relevant minimum vectoring altitude shall include a correction for low temperature effect.

Note 1.— When an IFR flight is being vectored, the pilot may be unable to determine the aircraft's exact position in respect to obstacles in this area and consequently the altitude which provides the required obstacle clearance. Detailed obstacle clearance criteria are contained in PANS-OPS (Doc 8168), Volumes I and II. See also 8.6.8.2.

Note 2.— It is the responsibility of the ATS authority to provide the controller with minimum altitudes corrected for temperature effect.

8.6.5.3 Whenever possible, minimum vectoring altitudes should be sufficiently high to minimize activation of aircraft ground proximity warning systems.

Note.— Activation of such systems will induce aircraft to pull up immediately and climb steeply to avoid hazardous terrain, possibly compromising separation between aircraft.

8.6.5.4 States shall encourage operators to report incidents involving activations of aircraft ground proximity warning systems so that their locations can be identified and altitude, routing and/or aircraft operating procedures can be altered to prevent recurrences.

8.6.5.5 In terminating vectoring of an aircraft, the controller shall instruct the pilot to resume own navigation, giving the pilot the aircraft's position and appropriate instructions, as necessary, in the form prescribed in 8.6.4.2 b), if the current instructions had diverted the aircraft from a previously assigned route.

8.6.6 Navigation assistance

8.6.6.1 An identified aircraft observed to deviate significantly from its intended route or designated holding pattern shall be advised accordingly. Appropriate action shall also be taken if, in the opinion of the controller, such deviation is likely to affect the service being provided.

8.6.6.2 The pilot of an aircraft requesting navigation assistance from an air traffic control unit providing ATS surveillance services shall state the reason (e.g. to avoid areas of adverse weather or unreliable navigational instruments) and shall give as much information as possible in the circumstances.

8.6.7 Interruption or termination of ATS surveillance service

8.6.7.1 An aircraft which has been informed that it is provided with ATS surveillance service should be informed immediately when, for any reason, the service is interrupted or terminated.

Note.— The transition of an aircraft across adjoining areas of radar and/or ADS-B and/or MLAT systems coverage will not normally constitute an interruption or termination of the ATS surveillance service.

8.6.7.2 When the control of an identified aircraft is to be transferred to a control sector that will provide the aircraft with procedural separation, the transferring controller shall ensure that appropriate procedural separation is established between that aircraft and any other controlled aircraft before the transfer is effected.

8.6.8 Minimum levels

8.6.8.1 The controller shall at all times be in possession of full and up-to-date information regarding:

- a) established minimum flight altitudes within the area of responsibility;
- b) the lowest usable flight level or levels determined in accordance with Chapters 4 and 5; and
- c) established minimum altitudes applicable to procedures based on tactical vectoring.

8.6.8.2 Unless otherwise specified by the appropriate ATS authority, minimum altitudes for procedures based on tactical vectoring with any ATS surveillance system shall be determined using the criteria applicable to tactical radar vectoring.

Note.— Criteria for the determination of minimum altitudes applicable to procedures based on tactical radar vectoring are contained in Procedures for Air Navigation Services — Aircraft Operations (PANS-OPS, Doc 8168), Volume II.

8.6.9 Information regarding adverse weather

8.6.9.1 Information that an aircraft appears likely to penetrate an area of adverse weather should be issued in sufficient time to permit the pilot to decide on an appropriate course of action, including that of requesting advice on how best to circumnavigate the adverse weather area, if so desired.

Note.— Depending on the capabilities of the ATS surveillance system, areas of adverse weather may not be presented on the situation display. An aircraft's weather radar will normally provide better detection and definition of adverse weather than radar sensors in use by ATS.

8.6.9.2 In vectoring an aircraft for circumnavigating any area of adverse weather, the controller should ascertain that the aircraft can be returned to its intended or assigned flight path within the coverage of the ATS surveillance system and, if this does not appear possible, inform the pilot of the circumstances.

Note.— Attention must be given to the fact that under certain circumstances the most active area of adverse weather may not be displayed.

8.6.10 Reporting of significant meteorological information to meteorological offices

Although a controller is not required to keep a special watch for heavy precipitation, etc., information on the position, intensity, extent and movement of significant meteorological conditions (i.e. heavy showers or well-defined frontal surfaces) as observed on situation displays should, when practicable, be reported to the associated meteorological office.

8.7 USE OF ATS SURVEILLANCE SYSTEMS IN THE AIR TRAFFIC CONTROL SERVICE

Note.— The procedures in this Section are general procedures applicable when an ATS surveillance system is used in the provision of area control service or approach control service. Additional procedures applicable in the provision of approach control service are detailed in Section 8.9.

8.7.1 Functions

The information provided by ATS surveillance systems and presented on a situation display may be used to perform the following functions in the provision of air traffic control service:

- a) provide ATS surveillance services as necessary in order to improve airspace utilization, reduce delays, provide for direct routings and more optimum flight profiles, as well as to enhance safety;
- b) provide vectoring to departing aircraft for the purpose of facilitating an expeditious and efficient departure flow and expediting climb to cruising level;
- c) provide vectoring to aircraft for the purpose of resolving potential conflicts;
- d) provide vectoring to arriving aircraft for the purpose of establishing an expeditious and efficient approach sequence;
- e) provide vectoring to assist pilots in their navigation, e.g. to or from a radio navigation aid, away from or around areas of adverse weather;
- f) provide separation and maintain normal traffic flow when an aircraft experiences communication failure within the area of coverage;
- g) maintain flight path monitoring of air traffic;

Note.— Where tolerances regarding such matters as adherence to track, speed or time have been prescribed by the appropriate ATS authority, deviations are not considered significant until such tolerances are exceeded.

- h) when applicable, maintain a watch on the progress of air traffic, in order to provide a procedural controller with:
 - i) improved position information regarding aircraft under control;
 - ii) supplementary information regarding other traffic; and
 - iii) information regarding any significant deviations by aircraft from the terms of their respective air traffic control clearances, including their cleared routes as well as levels, when appropriate.

8.7.2 Separation application

Note.— Factors which the controller using an ATS surveillance system must take into account in determining the spacing to be applied in particular circumstances in order to ensure that the separation minimum is not infringed include aircraft relative headings and speeds, ATS surveillance system technical limitations, controller workload and any difficulties caused by communication congestion. Guidance material on this subject is contained in the Air Traffic Services Planning Manual (Doc 9426).

8.7.2.1 Except as provided for in 8.7.2.8, 8.7.2.9 and 8.8.2.2, the separation minima specified in 8.7.3 shall only be applied between identified aircraft when there is reasonable assurance that identification will be maintained.

8.7.2.2 When control of an identified aircraft is to be transferred to a control sector that will provide the aircraft with procedural separation, such separation shall be established by the transferring controller before the aircraft reaches the limits of the transferring controller's area of responsibility, or before the aircraft leaves the relevant area of surveillance coverage.

8.7.2.3 When authorized by the appropriate ATS authority, separation based on the use of ADS-B, SSR and/or MLAT, and/or PSR position symbols and/or PSR blips shall be applied so that the distance between the centres of the position symbols and/or PSR blips, representing the positions of the aircraft concerned, is never less than a prescribed minimum.

8.7.2.4 Separation based on the use of PSR blips and SSR responses shall be applied so that the distance between the centre of the PSR blip and the nearest edge of the SSR response (or centre, when authorized by the appropriate ATS authority) is never less than a prescribed minimum.

8.7.2.5 Separation based on the use of ADS-B position symbols and SSR responses shall be applied so that the distance between the centre of the ADS-B position symbol and the nearest edge of the SSR response (or the centre, when authorized by the appropriate ATS authority) is never less than a prescribed minimum.

8.7.2.6 Separation based on the use of SSR responses shall be applied so that the distance between the closest edges of the SSR responses (of the centres, when authorized by the appropriate ATS authority) is never less than a prescribed minimum.

8.7.2.7 In no circumstances shall the edges of the position indications touch or overlap unless vertical separation is applied between the aircraft concerned, irrespective of the type of position indication displayed and separation minimum applied.

8.7.2.8 In the event that the controller has been notified of a controlled flight entering or about to enter the airspace within which the separation minima specified in 8.7.3 is applied, but has not identified the aircraft, the controller may, if so prescribed by the appropriate ATS authority, continue to provide an ATS surveillance service to identified aircraft provided that:

- a) reasonable assurance exists that the unidentified controlled flight will be identified using SSR and/or ADS-B and/or MLAT or the flight is being operated by an aircraft of a type which may be expected to give an adequate return on primary radar in the airspace within which the separation is applied; and
- b) the separation is maintained between identified flights and any other observed ATS surveillance system position indications until either the unidentified controlled flight has been identified or procedural separation has been established.

8.7.2.9 The separation minima specified in 8.7.3 may be applied between an aircraft taking off and a preceding departing aircraft or other identified traffic provided there is reasonable assurance that the departing aircraft will be identified within 2 km (1 NM) from the end of the runway, and that, at the time, the required separation will exist.

8.7.2.10 The separation minima specified in 8.7.3 shall not be applied between aircraft holding over the same holding fix. Application of ATS surveillance system separation minima based on radar and/or ADS-B and/or MLAT systems between holding aircraft and other flights shall be subject to requirements and procedures prescribed by the appropriate ATS authority.

8.7.3 Separation minima based on ATS surveillance systems

8.7.3.1 Unless otherwise prescribed in accordance with 8.7.3.2, 8.7.3.3 or 8.7.3.4, or Chapter 6 (with respect to independent and dependent parallel approaches), the horizontal separation minimum based on radar and/or ADS-B and/or MLAT systems shall be 9.3 km (5.0 NM).

8.7.3.2 The separation minimum in 8.7.3.1 may, if so prescribed by the appropriate ATS authority, be reduced, but not below:

- a) 5.6 km (3.0 NM) when radar and/or ADS-B and/or MLAT systems' capabilities at a given location so permit; and
- b) 4.6 km (2.5 NM) between succeeding aircraft which are established on the same final approach track within 18.5 km (10 NM) of the runway threshold. A reduced separation minimum of 4.6 km (2.5 NM) may be applied, provided:
 - i) the average runway occupancy time of landing aircraft is proven, by means such as data collection and statistical analysis and methods based on a theoretical model, not to exceed 50 seconds;
 - ii) braking action is reported as good and runway occupancy times are not adversely affected by runway contaminants such as slush, snow or ice;
 - iii) an ATS surveillance system with appropriate azimuth and range resolution and an update rate of 5 seconds or less is used in combination with suitable displays;
 - iv) the aerodrome controller is able to observe, visually or by means of surface movement radar (SMR), MLAT system or a surface movement guidance and control system (SMGCS), the runway-in-use and associated exit and entry taxiways;
 - v) distance-based wake turbulence separation minima in 8.7.3.4, or as may be prescribed by the appropriate ATS authority (e.g. for specific aircraft types), do not apply;
 - vi) aircraft approach speeds are closely monitored by the controller and when necessary adjusted so as to ensure that separation is not reduced below the minimum;
 - vii) aircraft operators and pilots have been made fully aware of the need to exit the runway in an expeditious manner whenever the reduced separation minimum on final approach is applied; and
 - viii) procedures concerning the application of the reduced minimum are published in AIPs.

8.7.3.3 The separation minimum or minima based on radar and/or ADS-B and/or MLAT systems to be applied shall be prescribed by the appropriate ATS authority according to the capability of the particular ATS surveillance system or sensor to accurately identify the aircraft position in relation to the centre of a position symbol, PSR blip, SSR response and taking into account factors which may affect the accuracy of the ATS surveillance system-derived information, such as aircraft range from the radar site and the range scale of the situation display in use.

8.7.3.4 The following distance-based wake turbulence separation minima shall be applied to aircraft being provided with an ATS surveillance service in the approach and departure phases of flight in the circumstances given in 8.7.3.4.1.

<i>Aircraft category</i>		<i>Distance-based wake turbulence separation minima</i>
<i>Preceding aircraft</i>	<i>Succeeding aircraft</i>	
HEAVY	HEAVY	7.4 km (4.0 NM)
	MEDIUM	9.3 km (5.0 NM)
	LIGHT	11.1 km (6.0 NM)
MEDIUM	LIGHT	9.3 km (5.0 NM)

Note.— *The provisions governing wake turbulence aircraft categorization are set forth in Chapter 4, Section 4.9.*

8.7.3.4.1 The minima set out in 8.7.3.4 shall be applied when:

- a) an aircraft is operating directly behind another aircraft at the same altitude or less than 300 m (1 000 ft) below; or
- b) both aircraft are using the same runway, or parallel runways separated by less than 760 m (2 500 ft); or
- c) an aircraft is crossing behind another aircraft, at the same altitude or less than 300 m (1 000 ft) below.

Note.— *See Figures 8-1A and 8-1B.*

8.7.4 Transfer of control

8.7.4.1 Where an ATS surveillance service is being provided, transfer of control should be effected, whenever practicable, so as to enable the uninterrupted provision of the ATS surveillance service.

8.7.4.2 Where SSR and/or ADS-B and/or MLAT is used and the display of position indications with associated labels is provided for, transfer of control of aircraft between adjacent control positions or between adjacent ATC units may be effected without prior coordination, provided that:

- a) updated flight plan information on the aircraft about to be transferred, including the discrete assigned SSR code or, with respect to Mode S and ADS-B, the aircraft identification, is provided to the accepting controller prior to transfer;
- b) the ATS surveillance system coverage provided to the accepting controller is such that the aircraft concerned is presented on the situation display before the transfer is effected and is identified on, but preferably before, receipt of the initial call;
- c) when the controllers are not physically adjacent, two-way direct speech facilities, which permit communications to be established instantaneously, are available between them at all times;

Note.— *“Instantaneous” refers to communications which effectively provide for immediate access between controllers.*

- d) the transfer point or points and all other conditions of application, such as direction of flight, specified levels, transfer of communication points, and especially an agreed minimum separation between aircraft, including that applicable to succeeding aircraft on the same route, about to be transferred as observed on the situation display, have been made the subject of specific instructions (for intra-unit transfer) or of a specific letter of agreement between two adjacent ATC units;
- e) the instructions or letter of agreement specify explicitly that the application of this type of transfer of control may be terminated at any time by the accepting controller, normally with an agreed advance notice;
- f) the accepting controller is informed of any level, speed or vectoring instructions given to the aircraft prior to its transfer and which modify its anticipated flight progress at the point of transfer.

8.7.4.3 The minimum agreed separation between aircraft about to be transferred (8.7.4.2 d) refers) and the advance notice (8.7.4.2 e) refers) shall be determined taking into account all relevant technical, operational and other circumstances. If circumstances arise in which these agreed conditions can no longer be satisfied, controllers shall revert to the procedure in 8.7.4.4 until the situation is resolved.

8.7.4.4 Where primary radar is being used, and where another type of ATS surveillance system is employed but the provisions of 8.7.4.2 are not applied, the transfer of control of aircraft between adjacent control positions or between two adjacent ATS units may be effected, provided that:

- a) identification has been transferred to or has been established directly by the accepting controller;
- b) when the controllers are not physically adjacent, two-way direct-speech facilities between them are at all times available which permit communications to be established instantaneously;
- c) separation from other controlled flights conforms to the minima authorized for use during transfer of control between the sectors or units concerned;
- d) the accepting controller is informed of any level, speed or vectoring instructions applicable to the aircraft at the point of transfer;
- e) radiocommunication with the aircraft is retained by the transferring controller until the accepting controller has agreed to assume responsibility for providing the ATS surveillance service to the aircraft. Thereafter, the aircraft should be instructed to change over to the appropriate channel and from that point is the responsibility of the accepting controller.

8.7.5 Speed control

Subject to conditions specified by the appropriate ATS authority, including consideration of aircraft performance limitations, a controller may, in order to facilitate sequencing or to reduce the need for vectoring, request aircraft to adjust their speed in a specified manner.

Note.— Procedures for speed control instructions are contained in Chapter 4, Section 4.6.

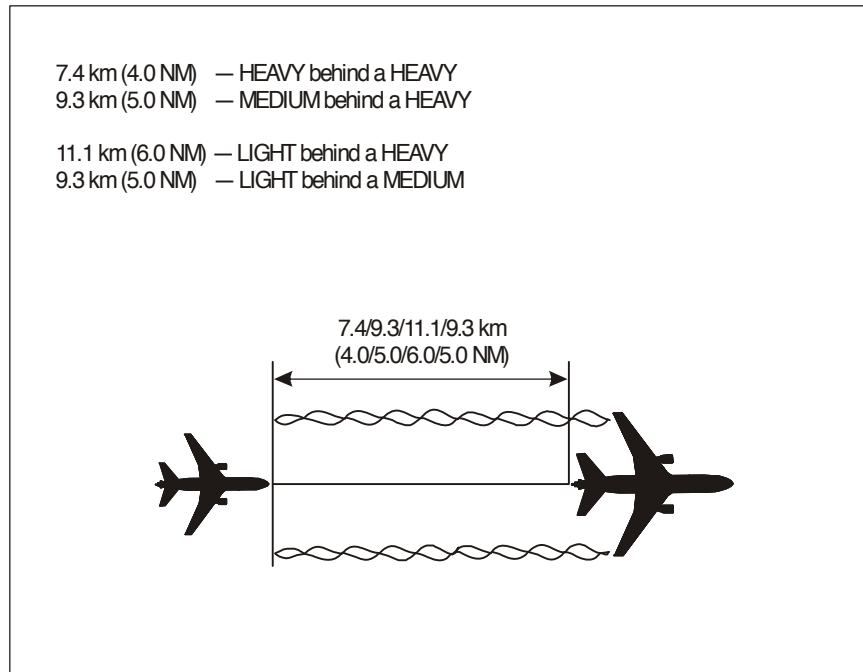

Figure 8-1A. Operating directly behind (see 8.7.3.4 and 8.7.3.4.1)

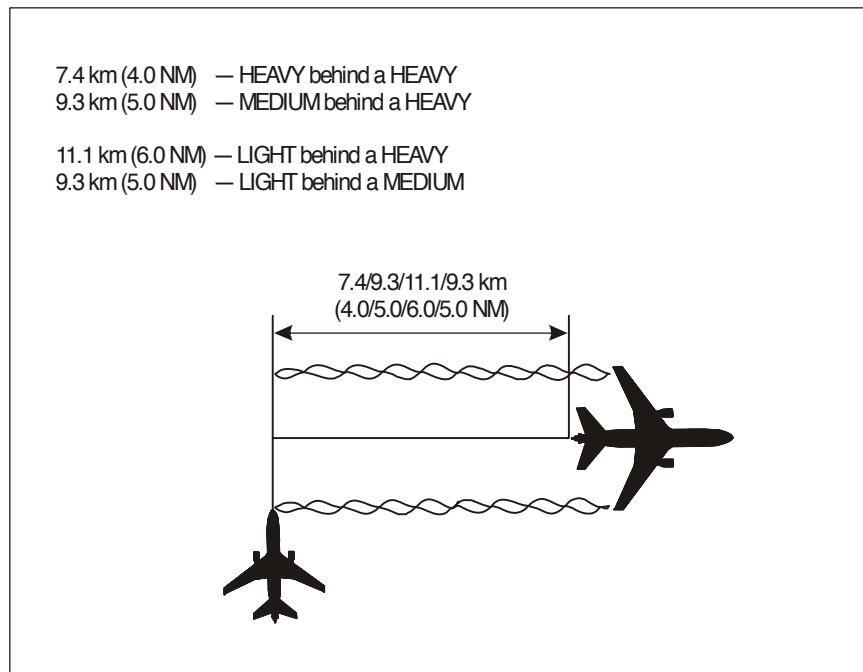

Figure 8-1B. Crossing behind (see 8.7.3.4 and 8.7.3.4.1)

8.8 EMERGENCIES, HAZARDS AND EQUIPMENT FAILURES

Note.— See also Chapter 15.

8.8.1 Emergencies

8.8.1.1 In the event of an aircraft in, or appearing to be in, any form of emergency, every assistance shall be provided by the controller, and the procedures prescribed herein may be varied according to the situation.

8.8.1.2 The progress of an aircraft in emergency shall be monitored and (whenever possible) plotted on the situation display until the aircraft passes out of coverage of the ATS surveillance system, and position information shall be provided to all air traffic services units which may be able to give assistance to the aircraft. Transfer to adjacent sectors shall also be effected when appropriate.

Note.— If the pilot of an aircraft encountering a state of emergency has previously been directed by ATC to select a specific transponder code and/or an ADS-B emergency mode, that code/mode will normally be maintained unless, in special circumstances, the pilot has decided or has been advised otherwise. Where ATC has not requested a code or emergency mode to be set, the pilot will set the transponder to Mode A Code 7700 and/or the appropriate ADS-B emergency mode.

8.8.1.3 Whenever a general ADS-B emergency alert is observed on the situation display and there is no other indication of the particular nature of the emergency, the controller shall take the following action:

- a) attempt to establish communication with the aircraft to verify the nature of the emergency; or
- b) if no response is received from the aircraft, the controller shall attempt to ascertain if the aircraft is able to receive transmissions from the air traffic control unit by requesting it to execute a specified manoeuvre which can be observed on the situation display.

Note 1.— Some aircraft equipped with first generation ADS-B avionics have the capability to transmit a general emergency alert only, regardless of the code selected by the pilot.

Note 2.— Some aircraft equipped with first generation ADS-B avionics do not have the capability of squawking IDENT while the emergency and/or urgency mode is selected.

8.8.2 Collision hazard information

8.8.2.1 When an identified controlled flight is observed to be on a conflicting path with an unknown aircraft deemed to constitute a collision hazard, the pilot of the controlled flight shall, whenever practicable:

- a) be informed of the unknown aircraft, and if so requested by the controlled flight or if, in the opinion of the controller, the situation warrants, a course of avoiding action should be suggested; and
- b) be notified when the conflict no longer exists.

8.8.2.2 When an identified IFR flight operating outside controlled airspace is observed to be on a conflicting path with another aircraft, the pilot should:

- a) be informed as to the need for collision avoidance action to be initiated, and if so requested by the pilot or if, in the opinion of the controller, the situation warrants, a course of avoiding action should be suggested; and
- b) be notified when the conflict no longer exists.

8.8.2.3 Information regarding traffic on a conflicting path should be given, whenever practicable, in the following form:

- a) relative bearing of the conflicting traffic in terms of the 12-hour clock;
- b) distance from the conflicting traffic in kilometres (nautical miles);
- c) direction in which the conflicting traffic appears to be proceeding;
- d) level and type of aircraft or, if unknown, relative speed of the conflicting traffic, e.g. slow or fast.

8.8.2.4 Pressure-altitude-derived level information, even when unverified, should be used in the provision of collision hazard information because such information, particularly if available from an otherwise unknown aircraft (e.g. a VFR flight) and given to the pilot of a known aircraft, could facilitate the location of a collision hazard.

8.8.2.4.1 When the pressure-altitude-derived level information has been verified, the information shall be passed to pilots in a clear and unambiguous manner. If the level information has not been verified, the accuracy of the information should be considered uncertain and the pilot shall be informed accordingly.

8.8.3 Failure of equipment

8.8.3.1 AIRCRAFT RADIO TRANSMITTER FAILURE

8.8.3.1.1 If two-way communication is lost with an aircraft, the controller should determine whether or not the aircraft's receiver is functioning by instructing the aircraft on the channel so far used to acknowledge by making a specified manoeuvre and by observing the aircraft's track, or by instructing the aircraft to operate IDENT or to make SSR code and/or ADS-B transmission changes.

Note 1.— Transponder-equipped aircraft experiencing radiocommunication failure will operate the transponder on Mode A Code 7600.

Note 2.— ADS-B-equipped aircraft experiencing radiocommunication failure may transmit the appropriate ADS-B emergency and/or urgency mode.

8.8.3.1.2 If the action prescribed in 8.8.3.1.1 is unsuccessful, it shall be repeated on any other available channel on which it is believed that the aircraft might be listening.

8.8.3.1.3 In both the cases covered by 8.8.3.1.1 and 8.8.3.1.2, any manoeuvring instructions shall be such that the aircraft would regain its current cleared track after having complied with the instructions received.

8.8.3.1.4 Where it has been established by the action in 8.8.3.1.1 that the aircraft's radio receiver is functioning, continued control can be effected using SSR code/ADS-B transmission changes or IDENT transmissions to obtain acknowledgement of clearances issued to the aircraft.

8.8.3.2 COMPLETE AIRCRAFT COMMUNICATION FAILURE

When a controlled aircraft experiencing complete communication failure is operating or expected to operate in an area and at flight levels where an ATS surveillance service is applied, separation specified in 8.7.3 may continue to be used. However, if the aircraft experiencing the communication failure is not identified, separation shall be applied between identified aircraft and all unidentified aircraft observed along the expected route of the aircraft with the communication failure, until such time as it is known, or can safely be assumed, that the aircraft with radiocommunication failure has passed through the airspace concerned, has landed, or has proceeded elsewhere.

8.8.3.3 AIRCRAFT TRANSPONDER FAILURE IN AREAS WHERE THE CARRIAGE OF A FUNCTIONING TRANSPONDER IS MANDATORY

8.8.3.3.1 When an aircraft experiencing transponder failure after departure is operating or expected to operate in an area where the carriage of a functioning transponder with specified capabilities is mandatory, the ATC units concerned should endeavour to provide for continuation of the flight to the aerodrome of first intended landing in accordance with the flight plan. However, in certain traffic situations, either in terminal areas or en-route, continuation of the flight may not be possible, particularly when failure is detected shortly after take-off. The aircraft may then be required to return to the departure aerodrome or to land at the nearest suitable aerodrome acceptable to the operator concerned and to ATC.

8.8.3.3.2 In case of a transponder failure which is detected before departure from an aerodrome where it is not practicable to effect a repair, the aircraft concerned should be permitted to proceed, as directly as possible, to the nearest suitable aerodrome where repair can be made. When granting clearance to such aircraft, ATC should take into consideration the existing or anticipated traffic situation and may have to modify the time of departure, flight level or route of the intended flight. Subsequent adjustments may become necessary during the course of the flight.

8.8.4 ATS surveillance system failure

8.8.4.1 In the event of complete failure of the ATS surveillance system where air-ground communications remain, the controller shall plot the positions of all aircraft already identified, take the necessary action to establish procedural separation between the aircraft and, if necessary, limit the number of aircraft permitted to enter the area.

8.8.4.2 As an emergency measure, use of flight levels spaced by half the applicable vertical separation minimum may be resorted to temporarily if standard procedural separation cannot be provided immediately.

8.8.5 Degradation of aircraft position source data

In order to reduce the impact of a degradation of aircraft position source data, for example, a receiver autonomous integrity monitoring (RAIM) outage for GNSS, the appropriate ATS authority shall establish contingency procedures to be followed by control positions and ATC units in the event of data degradation.

8.8.6 Ground radio failure

8.8.6.1 In the event of complete failure of the ground radio equipment used for control, the controller shall, unless able to continue to provide the ATS surveillance service by means of other available communication channels, proceed as follows:

- a) without delay inform all adjacent control positions or ATC units, as applicable, of the failure;

- b) apprise such positions or units of the current traffic situation;
- c) request their assistance, in respect of aircraft which may establish communications with those positions or units, in establishing and maintaining separation between such aircraft; and
- d) instruct adjacent control positions or ATC units to hold or re-route all controlled flights outside the area of responsibility of the position or ATC unit that has experienced the failure until such time that the provision of normal services can be resumed.

8.8.6.2 In order to reduce the impact of complete ground radio equipment failure on the safety of air traffic, the appropriate ATS authority should establish contingency procedures to be followed by control positions and ATC units in the event of such failures. Where feasible and practicable, such contingency procedures should provide for the delegation of control to an adjacent control position or ATC unit in order to permit a minimum level of services to be provided as soon as possible, following the ground radio failure and until normal operations can be resumed.

8.9 USE OF ATS SURVEILLANCE SYSTEMS IN THE APPROACH CONTROL SERVICE

8.9.1 General provisions

8.9.1.1 ATS surveillance systems used in the provision of approach control service shall be appropriate to the functions and level of service to be provided.

8.9.1.2 ATS surveillance systems used to monitor parallel ILS approaches shall meet the requirements for such operations specified in Chapter 6.

8.9.2 Functions

The position indications presented on a situation display may be used to perform the following additional functions in the provision of approach control service:

- a) provide vectoring of arriving traffic on to pilot-interpreted final approach aids;
- b) provide flight path monitoring of parallel ILS approaches and instruct aircraft to take appropriate action in the event of possible or actual penetrations of the no transgression zone (NTZ);

Note.— See Chapter 6, Section 6.7.

- c) provide vectoring of arriving traffic to a point from which a visual approach can be completed;
- d) provide vectoring of arriving traffic to a point from which a precision radar approach or a surveillance radar approach can be made;
- e) provide flight path monitoring of other pilot-interpreted approaches;

- f) in accordance with prescribed procedures, conduct:
 - i) surveillance radar approaches;
 - ii) precision radar (PAR) approaches; and
- g) provide separation between:
 - i) succeeding departing aircraft;
 - ii) succeeding arriving aircraft; and
 - iii) a departing aircraft and a succeeding arriving aircraft.

8.9.3 General approach control procedures using ATS surveillance systems

8.9.3.1 The appropriate ATS authority shall establish procedures to ensure that the aerodrome controller is kept informed of the sequence of arriving aircraft, as well as any instructions and restrictions which have been issued to such aircraft in order to maintain separation after transfer of control to the aerodrome controller.

8.9.3.2 Prior to, or upon commencement of, vectoring for approach, the pilot shall be advised of the type of approach as well as the runway to be used.

8.9.3.3 The controller shall advise an aircraft being vectored for an instrument approach of its position at least once prior to commencement of final approach.

8.9.3.4 When giving distance information, the controller shall specify the point or navigation aid to which the information refers.

8.9.3.5 The initial and intermediate approach phases of an approach executed under the direction of a controller comprise those parts of the approach from the time vectoring is initiated for the purpose of positioning the aircraft for a final approach, until the aircraft is on final approach and:

- a) established on the final approach path of a pilot-interpreted aid; or
- b) reports that it is able to complete a visual approach; or
- c) ready to commence a surveillance radar approach; or
- d) transferred to the precision radar approach controller.

8.9.3.6 Aircraft vectored for final approach should be given a heading or a series of headings calculated to close with the final approach track. The final vector shall enable the aircraft to be established on the final approach track prior to intercepting the specified or nominal glide path of the approach procedure from below, and should provide an intercept angle with the final approach track of 45 degrees or less.

Note.— See Chapter 6, Section 6.7.3.2, and Section 6.7.3.2.3 concerning vectoring and level flight requirements of independent parallel approaches, respectively.

8.9.3.7 Whenever an aircraft is assigned a vector which will take it through the final approach track, it should be advised accordingly, stating the reason for the vector.

8.9.4 Vectoring to pilot-interpreted final approach aid

8.9.4.1 An aircraft vectored to intercept a pilot-interpreted final approach aid shall be instructed to report when established on the final approach track. Clearance for the approach should be issued prior to when the aircraft reports established, unless circumstances preclude the issuance of the clearance at such time. Vectoring will normally terminate at the time the aircraft leaves the last assigned heading to intercept the final approach track.

8.9.4.2 When clearance for the approach is issued, aircraft shall maintain the last assigned level until intercepting the specified or nominal glide path of the approach procedure. If ATC requires an aircraft to intercept the glide path at a level other than a level flight segment depicted on the instrument approach chart, ATC shall instruct the pilot to maintain the particular level until established on the glide path.

8.9.4.3 The controller shall be responsible for maintaining separation specified in 8.7.3 between succeeding aircraft on the same final approach, except that the responsibility may be transferred to the aerodrome controller in accordance with procedures prescribed by the appropriate ATS authority and provided an ATS surveillance system is available to the aerodrome controller.

8.9.4.4 Transfer of control of succeeding aircraft on final approach to the aerodrome controller shall be effected in accordance with procedures prescribed by the appropriate ATS authority.

8.9.4.5 Transfer of communications to the aerodrome controller should be effected at such a point or time that clearance to land or alternative instructions can be issued to the aircraft in a timely manner.

8.9.5 Vectoring for visual approach

Note.— See also Chapter 6, Section 6.5.3.

8.9.5.1 The controller may initiate vectoring of an aircraft for visual approach provided the reported ceiling is above the minimum altitude applicable to vectoring and meteorological conditions are such that, with reasonable assurance, a visual approach and landing can be completed.

8.9.5.2 Clearance for visual approach shall be issued only after the pilot has reported the aerodrome or the preceding aircraft in sight, at which time vectoring would normally be terminated.

8.9.6 Radar approaches

8.9.6.1 GENERAL PROVISIONS

8.9.6.1.1 During the period that a controller is engaged in giving surveillance radar or precision radar approaches, he or she should not be responsible for any duties other than those directly connected with such approaches.

8.9.6.1.2 Controllers conducting radar approaches shall be in possession of information regarding the obstacle clearance altitudes/heights established for the types of approach to be conducted.

8.9.6.1.3 Prior to commencement of a radar approach, the aircraft shall be informed of:

- a) the runway to be used;
- b) the applicable obstacle clearance altitude/height;

- c) the angle of the nominal glide path and, if so prescribed by the appropriate ATS authority or requested by the aircraft, the approximate rate of descent to be maintained;

Note.— See the Air Traffic Services Planning Manual (Doc 9426) regarding calculation of approximate rates of descent.

- d) the procedure to be followed in the event of radiocommunication failure, unless the procedure has been published in AIPs.

8.9.6.1.4 When a radar approach cannot be continued due to any circumstance, the aircraft should be immediately informed that a radar approach or continuation thereof is not possible. The approach should be continued if this is possible using non-radar facilities or if the pilot reports that the approach can be completed visually; otherwise an alternative clearance should be given.

8.9.6.1.5 Aircraft making a radar approach should be reminded, when on final approach, to check that the wheels are down and locked.

8.9.6.1.6 Unless otherwise prescribed by the appropriate ATS authority, the controller conducting the approach should notify the aerodrome controller or, when applicable, the procedural controller when an aircraft making a radar approach is approximately 15 km (8 NM) from touchdown. If landing clearance is not received at this time, a subsequent notification should be made at approximately 8 km (4 NM) from touchdown and landing clearance requested.

8.9.6.1.7 Clearance to land or any alternative clearance received from the aerodrome controller or, when applicable, the procedural controller should normally be passed to the aircraft before it reaches a distance of 4 km (2 NM) from touchdown.

8.9.6.1.8 An aircraft making a radar approach should:

- a) be directed to execute a missed approach in the following circumstances:
 - i) when the aircraft appears to be dangerously positioned on final approach; or
 - ii) for reasons involving traffic conflicts; or
 - iii) if no clearance to land has been received from the procedural controller by the time the aircraft reaches a distance of 4 km (2 NM) from touchdown or such other distance as has been agreed with the aerodrome control tower; or
 - iv) on instructions by the aerodrome controller; or
- b) be advised to consider executing a missed approach in the following circumstances:
 - i) when the aircraft reaches a position from which it appears that a successful approach cannot be completed; or
 - ii) if the aircraft is not visible on the situation display for any significant interval during the last 4 km (2 NM) of the approach; or
 - iii) if the position or identification of the aircraft is in doubt during any portion of the final approach.

In all such cases, the reason for the instruction or the advice should be given to the pilot.

8.9.6.1.9 Unless otherwise required by exceptional circumstances, radar instructions concerning a missed approach should be in accordance with the prescribed missed approach procedure and should include the level to which the aircraft is to climb and heading instructions to keep the aircraft within the missed approach area during the missed approach procedure.

8.9.7 Final approach procedures

8.9.7.1 SURVEILLANCE RADAR APPROACH

8.9.7.1.1 A final approach using solely surveillance radar should not be carried out if precision approach radar is available, unless meteorological conditions are such as to indicate with reasonable certainty that a surveillance radar approach can be completed successfully.

8.9.7.1.2 A surveillance radar approach shall only be performed with equipment suitably sited and a situation display specifically marked to provide information on position relative to the extended centre line of the runway to be used and distance from touchdown, and which is specifically approved for the purpose by the appropriate ATS authority.

8.9.7.1.3 When conducting a surveillance radar approach, the controller shall comply with the following:

- a) at or before the commencement of the final approach, the aircraft shall be informed of the point at which the surveillance radar approach will be terminated;
- b) the aircraft shall be informed when it is approaching the point at which it is computed that descent should begin, and just before reaching that point it shall be informed of the obstacle clearance altitude/height and instructed to descend and check the applicable minima;
- c) azimuth instructions shall be given in accordance with the precision approach technique (see 8.9.7.2.4);
- d) except as provided in 8.9.7.1.4, distance from touchdown shall normally be passed at every 2 km (each NM);
- e) pre-computed levels through which the aircraft should be passing to maintain the glide path shall also be transmitted at every 2 km (each NM) at the same time as the distance;
- f) the surveillance radar approach shall be terminated:
 - i) at a distance of 4 km (2 NM) from touchdown, except as provided in 8.9.7.1.4; or
 - ii) before the aircraft enters an area of continuous radar clutter; or
 - iii) when the pilot reports that a visual approach can be effected;

whichever is the earliest.

8.9.7.1.4 When, as determined by the appropriate ATS authority, the accuracy of the radar equipment permits, surveillance radar approaches may be continued to the threshold of the runway, or to a prescribed point less than 4 km (2 NM) from touchdown, in which case:

- a) distance and level information shall be given at each km (each half NM);
- b) transmission should not be interrupted for intervals of more than five seconds while the aircraft is within a distance of 8 km (4 NM) from touchdown;

- c) the controller should not be responsible for any duties other than those directly connected with a particular approach.

8.9.7.1.5 Levels through which the aircraft should pass to maintain the required glide path, and the associated distances from touchdown, shall be pre-computed and displayed in such a manner as to be readily available to the controller concerned.

Note.— See the Air Traffic Services Planning Manual (Doc 9426) regarding pre-computation of levels.

8.9.7.2 PRECISION RADAR APPROACH

8.9.7.2.1 *DUTIES OF PRECISION APPROACH CONTROLLER*

During the period the controller is engaged in giving a precision approach, the controller should not be responsible for any duties other than those directly connected with that particular approach.

8.9.7.2.2 *TRANSFER OF CONTROL*

Aircraft to be provided with a precision radar approach shall have been transferred to the controller in charge of the precision approach at a distance of not less than 2 km (1 NM) from the point of interception of the glide path, unless otherwise provided by the appropriate ATS authority.

8.9.7.2.3 *COMMUNICATIONS*

When control of the aircraft is assumed by the controller in charge of the precision approach, a communications check shall be made on the channel to be used during the precision approach and the pilot shall be advised that no further acknowledgement of transmission is required. Thereafter, transmission should not be interrupted for intervals of more than five seconds while the aircraft is on final approach.

8.9.7.2.4 *AZIMUTH INFORMATION AND CORRECTIONS*

8.9.7.2.4.1 The pilot shall be informed at regular intervals of the aircraft's position in relation to the extended centre line of the runway. Heading corrections shall be given as necessary to bring the aircraft back on to the extended centre line.

8.9.7.2.4.2 In the case of azimuth deviations, the pilot should not take corrective action unless specifically instructed to do so.

8.9.7.2.5 *ELEVATION INFORMATION AND ADJUSTMENTS*

8.9.7.2.5.1 The aircraft shall be informed when it is approaching the point of interception of the glide path and, just before intercepting the glide path, it shall be instructed to begin its descent and to check the applicable decision altitude/height. Thereafter, the aircraft shall be informed at regular intervals of its position in relation to the glide path. When no corrections are required, the aircraft should be informed at regular intervals that it is on the glide path. Deviations from the glide path shall be given to the aircraft, together with instructions to adjust the rate of descent if the corrective action taken by the aircraft does not appear to be sufficient. The aircraft shall be informed when it starts to regain the glide path, and immediately before it reaches the glide path.

8.9.7.2.5.2 In the case of deviations from the glide path, the pilot should take corrective action on the basis of the information given by the controller, even though not specifically instructed to do so.

8.9.7.2.5.3 Prior to the aircraft reaching a point 4 km (2 NM) from touchdown, or a greater distance as necessary for faster aircraft, a certain degree of tolerance should be allowed with regard to deviations from the glide path, and elevation information need not specify the actual number of metres (or feet) above or below the glide path unless it is required to emphasize the rate of change or the extent of the displacement. Thereafter, any deviations from the glide path should be given to the aircraft, preferably in terms of specific distances (metres or feet) above or below the glide path. The use of emphasis in the manner in which the information is transmitted should normally be sufficient to expedite action by the pilot when necessary (e.g. “*STILL* 20 metres (60 feet) too low”).

8.9.7.2.5.4 Should the elevation element fail during a precision radar approach, the controller shall inform the aircraft immediately. If possible, the controller shall change to a surveillance radar approach, informing the aircraft of the revised obstacle clearance altitude/height. Alternatively, instructions should be given for a missed approach.

8.9.7.2.6 *DISTANCE INFORMATION*

The distance from touchdown should be transmitted at intervals of 2 km (1 NM) until the aircraft reaches a distance of 8 km (4 NM) from touchdown. Thereafter distance information should be transmitted at more frequent intervals, priority being given, however, to the provision of azimuth and elevation information and guidance.

8.9.7.2.7 *TERMINATION OF A PRECISION RADAR APPROACH*

A precision radar approach is terminated when the aircraft reaches the point at which the glide path intercepts the obstacle clearance altitude/height. Nevertheless, information shall continue to be given until the aircraft is over the threshold, or at such distance therefrom as may be specified by the appropriate ATS authority, taking into account the capability of the equipment concerned. The approach may be monitored to touchdown and information may continue to be provided as necessary at the discretion of the controller in charge of the precision approach in which case the aircraft shall be informed when it is over the threshold.

8.9.7.2.8 *MISSED APPROACHES*

When information provided by the elevation element indicates that the aircraft may be initiating a missed approach, the controller shall take the following action:

- a) when there is sufficient time to obtain a reply from the pilot (e.g. when the aircraft is more than 4 km (2 NM) from touchdown), the controller shall transmit the aircraft's height above the glide path and ask if the pilot intends to make a missed approach. If this is confirmed by the pilot, the controller shall pass missed approach instructions (see 8.9.6.1.8);
- b) when there is not sufficient time to obtain a reply from the pilot (e.g. when the aircraft is at 4 km (2 NM) or less from touchdown), the precision approach should be continued, emphasizing the aircraft's displacement, and terminated at the normal termination point. If it is apparent from elevation information that the aircraft is making a missed approach, either before or after the normal termination point, the controller shall pass missed approach instructions (see 8.9.6.1.8).

8.10 USE OF ATS SURVEILLANCE SYSTEMS IN THE AERODROME CONTROL SERVICE

8.10.1 Functions

8.10.1.1 When authorized by and subject to conditions prescribed by the appropriate ATS authority, ATS surveillance systems may be used in the provision of aerodrome control service to perform the following functions:

- a) flight path monitoring of aircraft on final approach;
- b) flight path monitoring of other aircraft in the vicinity of the aerodrome;
- c) establishing separation specified in 8.7.3 between succeeding departing aircraft; and
- d) providing navigation assistance to VFR flights.

8.10.1.2 Special VFR flights shall not be vectored unless special circumstances, such as emergencies, dictate otherwise.

8.10.1.3 Caution shall be exercised when vectoring VFR flights so as to ensure that the aircraft concerned does not inadvertently enter instrument meteorological conditions.

8.10.1.4 In prescribing conditions and procedures for the use of ATS surveillance systems in the provision of aerodrome control service, the appropriate ATS authority shall ensure that the availability and use of an ATS surveillance system will not be detrimental to visual observation of aerodrome traffic.

Note.— Control of aerodrome traffic is in the main based on visual observation of the manoeuvring area and the vicinity of the aerodrome by the aerodrome controller.

8.10.2 Use of ATS surveillance systems for surface movement control

Note.— Requirements concerning surface movement guidance and control systems (SMGCS) are contained in Annex 14, Volume I, Chapter 9. Guidance on the use of surface movement radar (SMR) and other advanced functions is contained in the Manual of Surface Movement Guidance and Control Systems (SMGCS) (Doc 9476) and in the Advanced Surface Movement Guidance and Control Systems (A-SMGCS) Manual (Doc 9830).

8.10.2.1 GENERAL PROVISIONS

8.10.2.1.1 The use of SMR should be related to the operational conditions and requirements of the particular aerodrome (i.e. visibility conditions, traffic density and aerodrome layout).

8.10.2.1.2 SMR systems shall to the extent possible enable the detection and display of the movement of all aircraft and vehicles on the manoeuvring area in a clear and unambiguous manner.

8.10.2.1.3 Aircraft and vehicle position indications may be displayed in symbolic or non-symbolic form. Where labels are available for display, the capability should be provided for inclusion of aircraft and vehicle identification by manual or automated means.

8.10.2.2 FUNCTIONS

8.10.2.2.1 SMR should be used to augment visual observation of traffic on the manoeuvring area and to provide surveillance of traffic on those parts of the manoeuvring area which cannot be observed visually.

8.10.2.2.2 The information displayed on an SMR display may be used to assist in:

- a) monitoring of aircraft and vehicles on the manoeuvring area for compliance with clearances and instructions;
- b) determining that a runway is clear of traffic prior to a landing or take-off;
- c) providing information on essential local traffic on or near the manoeuvring area;
- d) determining the location of aircraft and vehicles on the manoeuvring area;
- e) providing directional taxi information to aircraft when requested by the pilot or deemed necessary by the controller. Except under special circumstances, e.g. emergencies, such information should not be issued in the form of specific heading instructions; and
- f) providing assistance and advice to emergency vehicles.

8.10.2.3 IDENTIFICATION OF AIRCRAFT

Where an ATS surveillance system is used, aircraft may be identified by one or more of the following procedures:

- a) by correlating a particular position indication with:
 - i) an aircraft position visually observed by the controller;
 - ii) an aircraft position reported by the pilot; or
 - iii) an identified position indication displayed on a situation display;
- b) by transfer of identification when authorized by the appropriate ATS authority; and
- c) by automated identification procedures when authorized by the appropriate ATS authority.

8.11 USE OF ATS SURVEILLANCE SYSTEMS IN THE FLIGHT INFORMATION SERVICE

Note.— The use of an ATS surveillance system in the provision of flight information service does not relieve the pilot-in-command of an aircraft of any responsibilities, including the final decision regarding any suggested alteration of the flight plan.

8.11.1 Functions

The information presented on a situation display may be used to provide identified aircraft with:

- a) information regarding any aircraft observed to be on a conflicting path with the identified aircraft and suggestions or advice regarding avoiding action;
 - b) information on the position of significant weather and, as practicable, advice to the aircraft on how best to circumnavigate any such areas of adverse weather (see 8.6.9.2, Note);
 - c) information to assist the aircraft in its navigation.
-

Chapter 9

FLIGHT INFORMATION SERVICE AND ALERTING SERVICE

9.1. FLIGHT INFORMATION SERVICE

9.1.1 Recording and transmission of information on the progress of flights

Information on the actual progress of flights, including those of heavy or medium unmanned free balloons, under neither air traffic control service nor air traffic advisory service shall be:

- a) recorded by the air traffic services unit serving the FIR within which the aircraft is flying in such a manner that it is available for reference and in case it is requested for search and rescue action;
- b) transmitted by the air traffic services unit receiving the information to other air traffic services units concerned, when so required in accordance with Chapter 10, 10.2.2.

9.1.2 Transfer of responsibility for the provision of flight information service

The responsibility for the provision of flight information service to a flight normally passes from the appropriate ATS unit in an FIR to the appropriate ATS unit in the adjacent FIR at the time of crossing the common FIR boundary. However, when coordination is required in accordance with Chapter 10, 10.2, but communication facilities are inadequate, the former ATS unit shall, as far as practicable, continue to provide flight information service to the flight until it has established two-way communication with the appropriate ATS unit in the FIR it is entering.

9.1.3 Transmission of information

9.1.3.1 MEANS OF TRANSMISSION

9.1.3.1.1 Except as provided in 9.1.3.2.1, information shall be disseminated to aircraft by one or more of the following means as determined by the appropriate ATS authority:

- a) the preferred method of directed transmission on the initiative of the appropriate ATS unit to an aircraft, ensuring that receipt is acknowledged; or
- b) a general call, unacknowledged transmission to all aircraft concerned; or
- c) broadcast; or
- d) data link.

Note.— It should be recognized that in certain circumstances, e.g. during the last stages of a final approach, it may be impracticable for aircraft to acknowledge directed transmissions.

9.1.3.1.2 The use of general calls shall be limited to cases where it is necessary to disseminate essential information to several aircraft without delay, e.g. the sudden occurrence of hazards, a change of the runway-in-use, or the failure of a key approach and landing aid.

9.1.3.2 TRANSMISSION OF SPECIAL AIR-REPORTS,
SIGMET AND AIRMET INFORMATION

9.1.3.2.1 Appropriate SIGMET and AIRMET information, as well as special air-reports which have not been used for the preparation of a SIGMET, shall be disseminated to aircraft by one or more of the means specified in 9.1.3.1.1 as determined on the basis of regional air navigation agreements. Special air-reports shall be disseminated to aircraft for a period of 60 minutes after their issuance.

9.1.3.2.2 The special air-report, SIGMET and AIRMET information to be passed to aircraft on ground initiative should cover a portion of the route up to one hour's flying time ahead of the aircraft except when another period has been determined on the basis of regional air navigation agreements.

9.1.3.3 TRANSMISSION OF INFORMATION CONCERNING
VOLCANIC ACTIVITY

Information concerning pre-eruption volcanic activity, volcanic eruptions and volcanic ash clouds (position of clouds and flight levels affected) shall be disseminated to aircraft by one or more of the means specified in 9.1.3.1.1 as determined on the basis of regional air navigation agreements.

9.1.3.4 TRANSMISSION OF INFORMATION CONCERNING
RADIOACTIVE MATERIALS AND TOXIC CHEMICAL CLOUDS

Information on the release into the atmosphere of radioactive materials or toxic chemicals which could affect airspace within the area of responsibility of the ATS unit shall be transmitted to aircraft by one or more of the means specified in 9.1.3.1.1.

9.1.3.5 TRANSMISSION OF SPECI AND AMENDED TAF

9.1.3.5.1 Special reports in the SPECI code form and amended TAF shall be transmitted on request and supplemented by:

- a) directed transmission from the appropriate air traffic services unit of selected special reports and amended TAF for the departure, destination and its alternate aerodromes, as listed in the flight plan; or
- b) a general call on appropriate frequencies for the unacknowledged transmission to affected aircraft of selected special reports and amended TAF; or
- c) continuous or frequent broadcast or the use of data link to make available current METAR and TAF in areas determined on the basis of regional air navigation agreements where traffic congestion dictates. VOLMET broadcasts and/or D-VOLMET should be used to serve this purpose (see Annex 11, 4.4).

9.1.3.5.2 The passing of amended aerodrome forecasts to aircraft on the initiative of the appropriate air traffic services unit should be limited to that portion of the flight where the aircraft is within a specified time from the aerodrome of destination, such time being established on the basis of regional air navigation agreements.

9.1.3.6 TRANSMISSION OF INFORMATION ON HEAVY OR MEDIUM UNMANNED FREE BALLOONS

Appropriate information on heavy or medium unmanned free balloons shall be disseminated to aircraft by one or more of the means specified in 9.1.3.1.1.

9.1.3.7 TRANSMISSION OF INFORMATION TO SUPERSONIC AIRCRAFT

The following information shall be available at appropriate ACCs or flight information centres for aerodromes determined on the basis of regional air navigation agreements and shall be transmitted on request to supersonic aircraft prior to commencement of deceleration/descent from supersonic cruise:

- a) current meteorological reports and forecasts, except that where communications difficulties are encountered under conditions of poor propagation, the elements transmitted may be limited to:
 - i) mean surface wind, direction and speed (including gusts);
 - ii) visibility or runway visual range;
 - iii) amount and height of base of low clouds;
 - iv) other significant information;
 - v) if appropriate, information regarding expected changes;
- b) operationally significant information on the status of facilities relating to the runway-in-use, including the precision approach category in the event that the lowest approach category promulgated for the runway is not available;
- c) sufficient information on the runway surface conditions to permit assessment of the runway braking action.

9.1.4 Air traffic advisory service

9.1.4.1 OBJECTIVE AND BASIC PRINCIPLES

9.1.4.1.1 The objective of the air traffic advisory service is to make information on collision hazards more effective than it would be in the mere provision of flight information service. It may be provided to aircraft conducting IFR flights in advisory airspace or on advisory routes (Class F airspace). Such areas or routes will be specified by the State concerned.

9.1.4.1.2 Taking into account the considerations detailed in 2.4 of Annex 11, air traffic advisory service should only be implemented where the air traffic services are inadequate for the provision of air traffic control, and the limited advice on collision hazards otherwise provided by flight information service will not meet the requirement. Where air traffic advisory service is implemented, this should be considered normally as a temporary measure only until such time as it can be replaced by air traffic control service.

9.1.4.1.3 Air traffic advisory service does not afford the degree of safety and cannot assume the same responsibilities as air traffic control service in respect of the avoidance of collisions, since information regarding the disposition of traffic in the area concerned available to the unit providing air traffic advisory service may be incomplete.

To make this quite clear, air traffic advisory service does not deliver “clearances” but only “advisory information” and it uses the word “advise” or “suggest” when a course of action is proposed to an aircraft.

Note.— See 9.1.4.2.2.

9.1.4.2 AIRCRAFT

9.1.4.2.1 AIRCRAFT USING THE AIR TRAFFIC ADVISORY SERVICE

IFR flights electing to use or required by the appropriate ATS authority on the basis of regional air navigation agreements to use the air traffic advisory service when operating within Class F airspace are expected to comply with the same procedures as those applying to controlled flights except that:

- a) the flight plan and changes thereto are not subjected to a clearance, since the unit furnishing air traffic advisory service will only provide advice on the presence of essential traffic or suggestions as to a possible course of action;

Note 1.— It is assumed that a pilot will not effect a change in the current flight plan until he or she has notified the intended change to the appropriate ATS unit and, if practicable, has received acknowledgement or relevant advice.

Note 2.— When a flight is operating or about to operate in a control area to continue eventually into an advisory area or along an advisory route, a clearance may be issued for the whole route, but the clearance as such, or revisions thereto, applies only to those portions of the flight conducted within control areas and control zones (3.7.4.4 of Annex 11). Advice or suggestions would be provided as necessary for the remaining portion of the route.

- b) it is for the aircraft to decide whether or not it will comply with the advice or suggestion received and to inform the unit providing air traffic advisory service, without delay, of its decision;
- c) air-ground contacts shall be made with the air traffic services unit designated to provide air traffic advisory service within the advisory airspace or portion thereof.

Note.— See Chapter 4, 4.4.2, for procedures governing submission of a flight plan.

9.1.4.2.2 AIRCRAFT NOT USING THE AIR TRAFFIC ADVISORY SERVICE

9.1.4.2.2.1 Aircraft wishing to conduct IFR flights within advisory airspace, but not electing to use the air traffic advisory service, shall nevertheless submit a flight plan, and notify changes made thereto to the unit providing that service.

Note.— See Chapter 4, 4.4.2, for procedures governing submission of a flight plan.

9.1.4.2.2.2 IFR flights intending to cross an advisory route should do so as nearly as possible at an angle of 90 degrees to the direction of the route and at a level, appropriate to its track, selected from the tables of cruising levels prescribed for use by IFR flights operating outside controlled airspace.

9.1.4.3 AIR TRAFFIC SERVICES UNITS

Note.— The efficiency of air traffic advisory service will depend largely on the procedures and practices in use. Its establishment in line with the organization, procedures and equipment of area control service, taking into account the basic differences of the two services, as indicated in 9.1.4.2.1, will help to ensure a high degree of efficiency and promote

uniformity in the various provisions of air traffic advisory service. For example, exchange of information by the units concerned on the progress of an aircraft from one advisory area into an adjacent control area or terminal control area, and vice versa, will help to relieve pilots from repeating details of their flight plans already filed; also, use of standard air traffic control phraseology, preceded by the word “suggest” or “advise”, will facilitate the pilot’s understanding of air traffic advisory service intelligence.

9.1.4.3.1 An air traffic services unit providing air traffic advisory service shall:

- a) *advise* the aircraft to depart at the time specified and to cruise at the levels indicated in the flight plan if it does not foresee any conflict with other known traffic;
- b) *suggest* to aircraft a course of action by which a potential hazard may be avoided, giving priority to an aircraft already in advisory airspace over other aircraft desiring to enter such advisory airspace; and
- c) *pass* to aircraft traffic information comprising the same information as that prescribed for area control service.

9.1.4.3.2 The criteria used as a basis for action under b) and c) above should be at least those laid down for aircraft operating in controlled airspace and should take into account the limitations inherent in the provision of air traffic advisory service, navigation facilities and air-ground communications prevailing in the region.

9.2 ALERTING SERVICE

9.2.1 Aircraft

Note.— Whenever applied, the procedures for the provision of air traffic control service or air traffic advisory service take the place of the following procedures, except when relevant procedures do not call for more than hourly position reports, in which case the Operations normal procedure applies.

9.2.1.1 When so required by the appropriate ATS authority to facilitate the provision of alerting and search and rescue services, an aircraft, prior to and when operating within or into designated areas or along designated routes, shall comply with the provisions detailed in Annex 2, Chapter 3, concerning the submission, completion, changing and closing of a flight plan.

9.2.1.2 In addition to the above, aircraft equipped with suitable two-way radiocommunications shall report during the period twenty to forty minutes following the time of last contact, whatever the purpose of such contact, merely to indicate that the flight is progressing according to plan, such report to comprise identification of the aircraft and the words “Operations normal” or the signal QRU.

9.2.1.3 The “Operations normal” message shall be transmitted air-ground to an appropriate air traffic services unit (e.g. normally to the aeronautical telecommunication station serving the air traffic services unit in charge of the FIR in which the aircraft is flying, otherwise to another aeronautical telecommunication station to be retransmitted as required to the air traffic services unit in charge of the FIR).

9.2.1.4 It may be advisable, in case of a SAR operation of a substantial duration, to promulgate by NOTAM the lateral and vertical limits of the area of SAR action, and to warn aircraft not engaged in actual SAR operations and not controlled by air traffic control to avoid such areas unless otherwise authorized by the appropriate ATS unit.

9.2.2 Air traffic services units

9.2.2.1 When no report from an aircraft has been received within a reasonable period of time (which may be a specified interval prescribed on the basis of regional air navigation agreements) after a scheduled or expected reporting

time, the ATS unit shall, within the stipulated period of thirty minutes, endeavour to obtain such report in order to be in a position to apply the provisions relevant to the “Uncertainty Phase” (Annex 11, 5.2.1 refers) should circumstances warrant such application.

9.2.2.2 When alerting service is required in respect of a flight operated through more than one FIR or control area, and when the position of the aircraft is in doubt, responsibility for coordinating such service shall rest with the ATS unit of the FIR or control area:

- a) within which the aircraft was flying at the time of last air-ground radio contact;
- b) that the aircraft was about to enter when last air-ground contact was established at or close to the boundary of two FIRs or control areas;
- c) within which the aircraft’s intermediate stop or final destination point is located:
 - 1) if the aircraft was not equipped with suitable two-way radiocommunication equipment; or
 - 2) was not under obligation to transmit position reports.

9.2.2.3 The unit responsible for alerting service, in accordance with 9.2.2.2, shall:

- a) notify units providing alerting service in other affected FIRs or control areas of the emergency phase or phases, in addition to notifying the rescue coordination centre associated with it;
- b) request those units to assist in the search for any useful information pertaining to the aircraft presumed to be in an emergency, by all appropriate means and especially those indicated in 5.3 of Annex 11 (Use of communication facilities);
- c) collect the information gathered during each phase of the emergency and, after verifying it as necessary, transmit it to the rescue coordination centre;
- d) announce the termination of the state of emergency as circumstances dictate.

9.2.2.4 In obtaining the necessary information as required under 5.2.2.1 of Annex 11, attention shall particularly be given to informing the relevant rescue coordination centre of the distress frequencies available to survivors, as listed in Item 19 of the flight plan but not normally transmitted.

Chapter 10

COORDINATION

10.1 COORDINATION IN RESPECT OF THE PROVISION OF AIR TRAFFIC CONTROL SERVICE

10.1.1 General

10.1.1.1 The coordination and transfer of control of a flight between successive ATC units and control sectors shall be effected by a dialogue comprising the following stages:

- a) notification of the flight in order to prepare for coordination, as necessary;
- b) coordination of conditions of transfer of control by the transferring ATC unit;
- c) coordination, if necessary, and acceptance of conditions of transfer of control by the accepting ATC unit; and
- d) the transfer of control to the accepting ATC unit or control sector.

10.1.1.2 ATC units should, to the extent possible, establish and apply standardized procedures for the coordination and transfer of control of flights, in order, *inter alia*, to reduce the need for verbal coordination. Such coordination procedures shall conform to the procedures contained in the following provisions and be specified in letters of agreement and local instructions, as applicable.

10.1.1.3 Such agreements and instructions shall cover the following as applicable:

- a) definition of areas of responsibility and common interest, airspace structure and airspace classification(s);
- b) any delegation of responsibility for the provision of ATS;
- c) procedures for the exchange of flight plan and control data, including use of automated and/or verbal coordination messages;
- d) means of communication;
- e) requirements and procedures for approval requests;
- f) significant points, levels or times for transfer of control;
- g) significant points, levels or times for transfer of communication;
- h) conditions applicable to the transfer and acceptance of control, such as specified altitudes/flight levels, specific separation minima or spacing to be established at the time of transfer, and the use of automation;
- i) ATS surveillance system coordination procedures;
- j) SSR code assignment procedures;

- k) procedures for departing traffic;
- l) designated holding fixes and procedures for arriving traffic;
- m) applicable contingency procedures; and
- n) any other provisions or information relevant to the coordination and transfer of control of flights.

10.1.2 Coordination between ATC units providing air traffic service within contiguous control areas

10.1.2.1 GENERAL

10.1.2.1.1 ATC units shall forward from unit to unit, as the flight progresses, necessary flight plan and control information. When so required by agreement between the appropriate ATS authorities to assist in the separation of aircraft, flight plan and flight progress information for flights along specified routes or portions of routes in close proximity to flight information region boundaries shall also be provided to the ATC units in charge of the flight information regions adjacent to such routes or portions of routes.

Note 1.— Such a route or portion of route is often referred to as an area of common interest, the extent of which is usually determined by the required separation minima.

Note 2.— See also 10.2.4.

10.1.2.1.2 The flight plan and control information shall be transmitted in sufficient time to permit reception and analysis of the data by the receiving unit(s) and necessary coordination between the units concerned.

Note.— See Chapter 11 and Appendices 3 and 6 for details regarding messages, their content and time of transmission.

10.1.2.2 TRANSFER OF CONTROL

10.1.2.2.1 The responsibility for the control of an aircraft shall be transferred from the ATC unit to the next unit at the time of crossing the common control area boundary as determined by the unit having control of the aircraft or at such other point or time as has been agreed between the two units.

10.1.2.2.2 Where specified in letters of agreement between the ATC units concerned, and when transferring an aircraft, the transferring unit shall notify the accepting unit that the aircraft is in position to be transferred, and specify that the responsibility for control should be assumed by the accepting unit forthwith at the time of crossing the control boundary or other transfer control point specified in letters of agreement between the ATC units or at such other point or time coordinated between the two units.

10.1.2.2.3 If the transfer of control time or point is other than forthwith, the accepting ATC unit shall not alter the clearance of the aircraft prior to the agreed transfer of control time or point without the approval of the transferring unit.

10.1.2.2.4 If transfer of communication is used to transfer an aircraft to a receiving ATC unit, responsibility for control shall not be assumed until the time of crossing the control area boundary or other transfer of control point specified in letters of agreement between the ATC units.

10.1.2.2.5 When transfer of control of identified aircraft is to be effected, the appropriate procedures specified in Chapter 8, Section 8.7.4, shall be applied.

10.1.2.3 APPROVAL REQUESTS

10.1.2.3.1 If the flying time from the departure aerodrome of an aircraft to the boundary of an adjacent control area is less than the specified minimum required to permit transmission of the necessary flight plan and control information to the accepting ATC unit after take-off and allow adequate time for reception, analysis and coordination, the transferring ATC unit shall, prior to departure, forward that information to the accepting ATC unit together with a request for approval. The required time period shall be specified in letters of agreement or local instructions, as appropriate. In the case of revisions to a previously transmitted current flight plan, and control data being transmitted earlier than this specified time period, no approval from the accepting ATC unit shall be required.

10.1.2.3.2 In the case of an aircraft in flight requiring an initial clearance when the flying time to the boundary of an adjacent control area is less than a specified minimum, the aircraft shall be held within the transferring ATC unit's control area until the flight plan and control information have been forwarded together with a request for approval, and coordination effected, with the adjacent ATC unit.

10.1.2.3.3 In the case of an aircraft requesting a change in its current flight plan, or of a transferring ATC unit proposing to change the current flight plan of an aircraft, and the flying time of the aircraft to the control area boundary is less than a specified minimum, the revised clearance shall be withheld pending approval of the proposal by the adjacent ATC unit.

10.1.2.3.4 When boundary estimate data are to be transmitted for approval by the accepting unit, the time in respect of an aircraft not yet departed shall be based upon the estimated time of departure as determined by the ATC unit in whose area of responsibility the departure aerodrome is located. In respect of an aircraft in flight requiring an initial clearance, the time shall be based on the estimated elapsed time from the holding fix to the boundary plus the time expected to be needed for coordination.

10.1.2.3.5 The conditions, including specified flying times, under which approval requests shall be forwarded, shall be specified in letters of agreement or local instructions as appropriate.

10.1.2.4 TRANSFER OF COMMUNICATION

10.1.2.4.1 Except when separation minima specified in 8.7.3 are being applied, the transfer of air-ground communications of an aircraft from the transferring to the accepting ATC unit shall be made five minutes before the time at which the aircraft is estimated to reach the common control area boundary, unless otherwise agreed between the two ATC units concerned.

10.1.2.4.2 When separation minima specified in 8.7.3 are being applied at the time of transfer of control, the transfer of air-ground communications of an aircraft from the transferring to the accepting ATC unit shall be made immediately after the accepting ATC unit has agreed to assume control.

10.1.2.4.3 The accepting ATC unit shall normally not be required to notify the transferring unit that radio and/or data communication has been established with the aircraft being transferred and that control of the aircraft has been assumed, unless otherwise specified by agreement between the ATC units concerned. The accepting ATC unit shall notify the transferring unit in the event that communication with the aircraft is not established as expected.

10.1.2.4.4 In cases where a portion of a control area is so situated that the time taken by aircraft to traverse it is of a limited duration, agreement should be reached to provide for direct transfer of communication between the units responsible for the adjacent control areas, provided that the intermediate unit is fully informed of such traffic. The intermediate unit shall retain responsibility for coordination and for ensuring that separation is maintained between all traffic within its area of responsibility.

10.1.2.4.5 An aircraft may be permitted to communicate temporarily with a control unit other than the unit controlling the aircraft.

10.1.2.5 TERMINATION OF CONTROLLED FLIGHT

In the case where a flight ceases to be operated as a controlled flight, i.e. by leaving controlled airspace or by cancelling its IFR flight and proceeding on VFR in airspace where VFR flights are not controlled, the ATC unit concerned shall ensure that appropriate information on the flight is forwarded to ATS unit(s) responsible for the provision of flight information and alerting services for the remaining portion of the flight, in order to ensure that such services will be provided to the aircraft.

10.1.3 Coordination between a unit providing area control service and a unit providing approach control service

10.1.3.1 DIVISION OF CONTROL

10.1.3.1.1 Except when otherwise specified in letters of agreement or local instructions, or by the ACC concerned in individual cases, a unit providing approach control service may issue clearances to any aircraft released to it by an ACC without reference to the ACC. However, when an approach has been missed the ACC shall, if affected by the missed approach, be advised immediately and subsequent action coordinated between the ACC and the unit providing approach control service as necessary.

10.1.3.1.2 An ACC may, after coordination with the unit providing approach control service, release aircraft directly to aerodrome control towers if the entire approach will be made under visual meteorological conditions.

10.1.3.2 TAKE-OFF AND CLEARANCE EXPIRY TIMES

10.1.3.2.1 Time of take-off shall be specified by the ACC when it is necessary to:

- a) coordinate the departure with traffic not released to the unit providing approach control service; and
- b) provide en-route separation between departing aircraft following the same track.

10.1.3.2.2 If time of take-off is not specified, the unit providing approach control service shall determine the take-off time when necessary to coordinate the departure with traffic released to it.

10.1.3.2.3 A clearance expiry time shall be specified by the ACC if a delayed departure would conflict with traffic not released to the unit providing approach control service. If, for traffic reasons of its own, a unit providing approach control service has to specify in addition its own clearance expiry time, this shall not be later than that specified by the ACC.

10.1.3.3 EXCHANGE OF MOVEMENT AND CONTROL DATA

10.1.3.3.1 The unit providing approach control service shall keep the ACC promptly advised of pertinent data on controlled traffic such as:

- a) runway(s)-in-use and expected type of instrument approach procedure;
- b) lowest vacant level at the holding fix available for use by the ACC;
- c) average time interval or distance between successive arrivals as determined by the unit providing approach control service;
- d) revision of the expected approach time issued by the ACC when the calculation of the expected approach time by the unit providing approach control service indicates a variation of five minutes or such other time as has been agreed between the two ATC units concerned;

- e) arrival times over the holding fix when these vary by three minutes, or such other time as has been agreed between the two ATC units concerned, from those previously estimated;
- f) cancellations by aircraft of IFR flight, if these will affect levels at the holding fix or expected approach times of other aircraft;
- g) aircraft departure times or, if agreed between the two ATC units concerned, the estimated time at the control area boundary or other specified point;
- h) all available information relating to overdue or unreported aircraft;
- i) missed approaches which may affect the ACC.

10.1.3.3.2 The ACC shall keep the unit providing approach control service promptly advised of pertinent data on controlled traffic such as:

- a) identification, type and point of departure of arriving aircraft;
- b) estimated time and proposed level of arriving aircraft over holding fix or other specified point;
- c) actual time and proposed level of arriving aircraft over holding fix if aircraft is released to the unit providing approach control service after arrival over the holding fix;
- d) requested type of IFR approach procedure if different to that specified by the approach control unit;
- e) expected approach time issued;
- f) when required, statement that aircraft has been instructed to contact the unit providing approach control service;
- g) when required, statement that an aircraft has been released to the unit providing approach control service including, if necessary, the time and conditions of release;
- h) anticipated delay to departing traffic due to congestion.

10.1.3.3.3 Information on arriving aircraft shall be forwarded not less than fifteen minutes before estimated time of arrival and such information shall be revised as necessary.

10.1.4 Coordination between a unit providing approach control service and a unit providing aerodrome control service

10.1.4.1 DIVISION OF CONTROL

10.1.4.1.1 A unit providing approach control service shall retain control of arriving aircraft until such aircraft have been transferred to the aerodrome control tower and are in communication with the aerodrome control tower. Letters of agreement or local instructions, appropriate to the airspace structure, terrain, meteorological conditions and ATS facilities available, shall establish rules for the transfer of arriving aircraft.

10.1.4.1.2 A unit providing approach control service may authorize an aerodrome control tower to release an aircraft for take-off subject to the discretion of the aerodrome control tower with respect to arriving aircraft.

10.1.4.1.3 Aerodrome control towers shall, when so prescribed in letters of agreement or local instructions, obtain approval from the unit providing approach control service prior to authorizing operation of special VFR flights.

10.1.4.2 EXCHANGE OF MOVEMENT AND CONTROL DATA

10.1.4.2.1 An aerodrome control tower shall keep the unit providing approach control service promptly advised of pertinent data on relevant controlled traffic such as:

- a) arrival and departure times;
- b) when required, statement that the first aircraft in an approach sequence is in communication with and is sighted by the aerodrome control tower, and that reasonable assurance exists that a landing can be accomplished;
- c) all available information relating to overdue or unreported aircraft;
- d) information concerning missed approaches;
- e) information concerning aircraft that constitute essential local traffic to aircraft under the control of the unit providing approach control service.

10.1.4.2.2 The unit providing approach control service shall keep the aerodrome control tower promptly advised of pertinent data on controlled traffic such as:

- a) estimated time and proposed level of arriving aircraft over the aerodrome, at least fifteen minutes prior to estimated arrival;
- b) when required, a statement that an aircraft has been instructed to contact the aerodrome control tower and that control shall be assumed by that unit;
- c) anticipated delay to departing traffic due to congestion.

10.1.5 Coordination between control positions within the same unit

10.1.5.1 Appropriate flight plan and control information shall be exchanged between control positions within the same air traffic control unit, in respect of:

- a) all aircraft for which responsibility for control will be transferred from one control position to another;
- b) aircraft operating in such close proximity to the boundary between control sectors that control of traffic within an adjacent sector may be affected;
- c) all aircraft for which responsibility for control has been delegated by a controller using procedural methods to a controller using an ATS surveillance system, as well as other aircraft affected.

10.1.5.2 Procedures for coordination and transfer of control between control sectors within the same ATC unit shall conform to the procedures applicable to ATC units.

10.1.6 Failure of automated coordination

The failure of automated coordination shall be presented clearly to the controller responsible for coordinating the flight at the transferring unit. This controller shall then facilitate the required coordination using prescribed alternative methods.

10.2 COORDINATION IN RESPECT OF THE PROVISION OF FLIGHT INFORMATION SERVICE AND ALERTING SERVICE

10.2.1 Where this is deemed necessary by the appropriate ATS authority or authorities, coordination between ATS units providing flight information service in adjacent FIRs shall be effected in respect of IFR and VFR flights, in order to ensure continued flight information service to such aircraft in specified areas or along specified routes. Such coordination shall be effected in accordance with an agreement between the ATS units concerned.

10.2.2 Where coordination of flights is effected in accordance with 10.2.1, this shall include transmission of the following information on the flight concerned:

- a) appropriate items of the current flight plan; and
- b) the time at which last contact was made with the aircraft concerned.

10.2.3 This information shall be forwarded to the ATS unit in charge of the next FIR in which the aircraft will operate prior to the aircraft entering such FIR.

10.2.4 When so required by agreement between the appropriate ATS authorities to assist in the identification of strayed or unidentified aircraft and thereby eliminate or reduce the need for interception, flight plan and flight progress information for flights along specified routes or portions of routes in close proximity to FIR boundaries shall also be provided to the ATS units in charge of the FIRs adjacent to such routes or portions of routes.

10.2.5 In circumstances where an aircraft has declared minimum fuel or is experiencing an emergency or in any other situation wherein the safety of the aircraft is not assured, the type of emergency and/or the circumstances experienced by the aircraft shall be reported by the transferring unit to the accepting unit and any other ATS unit that may be concerned with the flight and to the associated rescue coordination centres, if necessary.

10.3 COORDINATION IN RESPECT OF THE PROVISION OF AIR TRAFFIC ADVISORY SERVICE

ATS units providing air traffic advisory service shall apply the coordination procedures specified in Section 10.1 with respect to such aircraft having elected to use this type of service.

10.4 COORDINATION BETWEEN AIR TRAFFIC SERVICES UNITS AND AERONAUTICAL TELECOMMUNICATION STATIONS

When so prescribed by the appropriate ATS authority, ATS units shall ensure that the aeronautical telecommunications stations serving the centres concerned are informed regarding transfers of communications contact by aircraft. Unless otherwise provided, information to be made available shall comprise the identification of the aircraft (including SELCAL code, when necessary), the route or destination (where necessary), and the expected or actual time of communications transfer.

Chapter 11

AIR TRAFFIC SERVICES MESSAGES

11.1 CATEGORIES OF MESSAGES

11.1.1 General

In accordance with the requirements in Chapter 10 — *Coordination*, the messages listed below are authorized for transmission via the aeronautical fixed service (including the aeronautical telecommunication network (ATN) and the aeronautical fixed telecommunication network (AFTN), direct-speech circuits or digital data interchange between ATS units, and direct teletypewriter and computer-computer circuits), or via the aeronautical mobile service, as applicable. They are classified in categories relating to their use by the air traffic services and providing an approximate indication of their importance.

Note.— The Priority Indicator in parentheses after each type of message is that specified in Annex 10 (Volume II, Chapter 4) for application when the message is transmitted on the AFTN. The priority for all ATS interfacility data communication (AIDC) messages using the ATN shall be “normal priority flight safety messages” as determined by the ATN Internet protocol priority categorization.

11.1.2 Emergency messages

This category comprises:

- a) distress messages and distress traffic, including messages relating to a distress phase (SS);
- b) urgency messages, including messages relating to an alert phase or to an uncertainty phase (DD);
- c) other messages concerning known or suspected emergencies which do not fall under a) or b) above, and radiocommunication failure messages (FF or higher as required).

Note.— When the messages in a) and b) and, if required, in c) above are filed with the public telecommunication service, the Priority Indicator SVH, assigned to telegrams relating to the safety of life, is to be used in accordance with Article 25 of the International Telecommunication Convention, Malaga, 1973.

11.1.3 Movement and control messages

This category comprises:

- a) movement messages (FF), including:
 - filed flight plan messages
 - delay messages

- modification messages
 - flight plan cancellation messages
 - departure messages
 - arrival messages;
- b) coordination messages (FF), including:
- current flight plan messages
 - estimate messages
 - coordination messages
 - acceptance messages
 - logical acknowledgement messages;
- c) supplementary messages (FF), including:
- request flight plan messages
 - request supplementary flight plan messages
 - supplementary flight plan messages;
- d) AIDC messages, including:
- notification messages
 - coordination messages
 - transfer of control messages
 - general information messages
 - application management messages;
- e) control messages (FF), including:
- clearance messages
 - flow control messages
 - position-report and air-report messages.

11.1.4 Flight information messages

11.1.4.1 This category comprises:

- a) messages containing traffic information (FF);
- b) messages containing meteorological information (FF or GG);
- c) messages concerning the operation of aeronautical facilities (GG);
- d) messages containing essential aerodrome information (GG);
- e) messages concerning air traffic incident reports (FF).

11.1.4.2 When justified by the requirement for special handling, messages transmitted via the AFTN should be assigned the Priority Indicator DD in place of the normal Priority Indicator.

11.2 GENERAL PROVISIONS

Note.— The use in this chapter of expressions such as “originated”, “transmitted”, “addressed” or “received” does not necessarily imply that reference is made to a teletypewriter or digital data interchange for a computer-to-computer message. Except where specifically indicated, the messages described in this chapter may also be transmitted by voice, in which case the four terms above represent “initiated”, “spoken by”, “spoken to” and “listened to” respectively.

11.2.1 Origination and addressing of messages

11.2.1.1 GENERAL

Note.— Movement messages in this context comprise flight plan messages, departure messages, delay messages, arrival messages, cancellation messages and position-report messages and modification messages relevant thereto.

11.2.1.1.1 Messages for ATS purposes shall be originated by the appropriate ATS units or by aircraft as specified in Section 11.3, except that, through special local arrangements, ATS units may delegate the responsibility for originating movement messages to the pilot, the operator, or its designated representative.

11.2.1.1.2 Origination of movement, control and flight information messages for purposes other than air traffic services (e.g. operational control) shall, except as provided for in Annex 11, 2.17, be the responsibility of the pilot, the operator, or a designated representative.

11.2.1.1.3 Flight plan messages, amendment messages related thereto and flight plan cancellation messages shall, except as provided in 11.2.1.1.4, be addressed only to those ATS units which are specified in the provisions of 11.4.2. Such messages shall be made available to other ATS units concerned, or to specified positions within such units and to any other addressees of the messages, in accordance with local arrangements.

11.2.1.1.4 When so requested by the operator concerned, emergency and movement messages which are to be transmitted simultaneously to ATS units concerned, shall also be addressed to:

- a) one addressee at the destination aerodrome or departure aerodrome; and
- b) not more than two operational control units concerned;

such addressees to be specified by the operator or its designated representative.

11.2.1.1.5 When so requested by the operator concerned, movement messages transmitted progressively between ATS units concerned and relating to aircraft for which operational control service is provided by that operator shall, so far as practicable, be made available immediately to the operator or its designated representative in accordance with agreed local procedures.

11.2.1.2 USE OF THE AFTN

11.2.1.2.1 ATS messages to be transmitted via the AFTN shall contain:

- a) information in respect of the priority with which they are to be transmitted and the addressees to whom they are to be delivered, and an indication of the date and time at which they are filed with the aeronautical fixed station concerned and of the Originator Indicator (see 11.2.1.2.5);
- b) the ATS data, preceded if necessary by the supplementary address information described in 11.2.1.2.6, and prepared in accordance with Appendix 3. These data will be transmitted as the text of the AFTN message.

11.2.1.2.2 *PRIORITY INDICATOR*

This shall consist of the appropriate two-letter Priority Indicator for the message as shown in parentheses for the appropriate category of message in Section 11.1.

Note.— It is prescribed in Annex 10 (Volume II, Chapter 4) that the order of priority for the transmission of messages in the AFTN shall be as follows:

<i>Transmission Priority</i>	<i>Priority Indicator</i>
1	SS
2	DD FF
3	GG KK

11.2.1.2.3 *ADDRESS*

11.2.1.2.3.1 This shall consist of a sequence of Addressee Indicators, one for each addressee to whom the message is to be delivered.

11.2.1.2.3.2 Each Addressee Indicator shall consist of an eight-letter sequence comprising, in the following order:

- a) the ICAO four-letter location indicator assigned to the place of destination;

Note.— A list of ICAO location indicators is contained in Doc 7910 — Location Indicators.

- b) i) the ICAO three-letter designator identifying the aeronautical authority, service or aircraft operating agency addressed, or

- ii) in cases where no designator has been assigned, one of the following:

- “YXY” in the case where the addressee is a military service/organization,
- “ZZZ” in the case where the addressee is an aircraft in flight,
- “YYY” in all other cases;

Note.— A list of ICAO three-letter designators is contained in Doc 8585 — Designators for Aircraft Operating Agencies, Aeronautical Authorities and Services.

- c) i) the letter X, or

- ii) the one-letter designator identifying the department or division of the organization addressed.

11.2.1.2.3.3 The following three-letter designators shall be used when addressing ATS messages to ATS units:

Centre in charge of a flight information region or an upper flight information region (whether ACC or FIC):

- if the message is relevant to an IFR flight ZQZ
- if the message is relevant to a VFR flight ZFZ

Aerodrome control tower	ZTZ
Air traffic services reporting office	ZPZ

Other three-letter designators for ATS units shall not be used for that purpose.

11.2.1.2.4 FILING TIME

The filing time shall consist of a six-digit date-time group indicating the date and the time of filing the message for transmission with the aeronautical fixed station concerned.

11.2.1.2.5 ORIGINATOR INDICATOR

The Originator Indicator shall consist of an eight-letter sequence, similar to an Addressee Indicator (see 11.2.1.2.3.2), identifying the place of origin and the organization originating the message.

11.2.1.2.6 SUPPLEMENTARY INFORMATION ON THE ADDRESS AND THE ORIGIN

The following supplementary information is required when, in the Indicators of the Address and/or Origin, the three-letter designators “YXY”, “ZZZ” or “YYY” (see 11.2.1.2.3.2 b) ii)) are used:

- a) the name of the organization or the identity of the aircraft concerned is to appear at the beginning of the text;
- b) the order of such insertions is to be the same as the order of the Addressee Indicators and/or the Originator Indicator;
- c) where there are more than one such insertion, the last should be followed by the word “STOP”;
- d) where there are one or more insertions in respect of Addressee Indicators plus an insertion in respect of the Originator Indicator, the word “FROM” is to appear before that relating to the Originator Indicator.

Note.— Regarding ATS messages received in teletypewriter page-copy form:

- 1) *ATS messages received via the AFTN will have been placed within a communications “envelope” (preceding and following character sequences which are necessary to ensure correct transmission via the AFTN). Even the text of the AFTN message may be received with words or groups preceding and following the ATS text.*
- 2) *The ATS message may then be located by the simple rule that it is preceded by an open bracket, e.g. ‘(’ and followed by a close bracket, e.g. ‘)’.*
- 3) *In some local cases, the teletypewriter machines in use will always print two specific symbols other than open bracket and close bracket on receipt of ATS messages constructed as prescribed in Appendix 3. Such local variants are easily learned and are of no consequence.*

11.2.2 Preparation and transmission of messages

11.2.2.1 Except as provided for in 11.2.2.2, ATS messages shall be prepared and transmitted with standard texts in a standard format and in accordance with standard data conventions, as and when prescribed in Appendix 3.

11.2.2.2 Where appropriate, the messages prescribed in Appendix 3 shall be supplemented with, and/or replaced by, AIDC messages prescribed in Appendix 6, on the basis of regional air navigation agreements.

11.2.2.2.1 Where AIDC messages are transmitted via the ATN, the messages shall utilize the packed encoding rules using *abstract syntax notation one* (ASN.1).

Note.— Provisions and information on the ASN.1 packed encoding rules and AIDC addressing rules are contained in Annex 10, Volume II, and the Manual of Technical Provisions for the Aeronautical Telecommunication Network (ATN) (Doc 9705). Guidance material concerning the operational use of AIDC messages is contained in the Manual of Air Traffic Services Data Link Applications (Doc 9694).

11.2.2.2.2 Where AIDC messages are transmitted via the AFTN, the format for the AIDC messages shall, as far as practicable, comply with the appropriate data conventions contained in Appendix 3. AIDC data fields to be transmitted via the AFTN that are inconsistent with, or additional to, the data conventions contained in Appendix 3 shall be provided for on the basis of regional air navigation agreements.

11.2.2.3 When messages are exchanged orally between the relevant ATS units, an oral acknowledgement shall constitute evidence of receipt of the message. No confirmation in written form directly between controllers shall therefore be required. The confirmation of coordination via the exchange of messages between automated systems shall be required unless special arrangements have been made between the units concerned.

Note.— See Annex 11, Chapter 6, regarding the requirement for recording of direct-speech communications.

11.3 METHODS OF MESSAGE EXCHANGE

11.3.1 The lead-time requirements of air traffic control and flow control procedures shall determine the method of message exchange to be used for the exchange of ATS data.

11.3.1.1 The method of message exchange shall also be dependent upon the availability of adequate communications channels, the function to be performed, the types of data to be exchanged and the processing facilities at the centres concerned.

11.3.2 Basic flight plan data necessary for flow control procedures shall be furnished at least 60 minutes in advance of the flight. Basic flight plan data shall be provided by either a filed flight plan or a repetitive flight plan submitted by mail in the form of a repetitive flight plan listing form or other media suitable for electronic data-processing systems.

11.3.2.1 Flight plan data submitted in advance of flight shall be updated by time, level and route changes and other essential information as may be necessary.

11.3.3 Basic flight plan data necessary for air traffic control purposes shall be furnished to the first en-route control centre at least 30 minutes in advance of the flight, and to each successive centre at least 20 minutes before the aircraft enters that centre's area of jurisdiction, in order for it to prepare for the transfer of control.

11.3.4 Except as provided for in 11.3.5, the second en-route centre and each successive centre shall be provided with current data, including updated basic flight plan data, contained in a current flight plan message or in an estimate message supplementing already available updated basic flight plan data.

11.3.5 In areas where automated systems are utilized for the exchange of flight plan data and where these systems provide data for several ACCs, approach control units and/or aerodrome control towers, the appropriate messages shall not be addressed to each individual ATS unit, but only to these automated systems.

Note.— Further processing and distribution of the data to its associated ATS units is the internal task of the receiving system.

11.3.5.1 When AIDC messages are used, the sending unit shall determine the identity of the receiving ATS unit and all messages shall contain the identification of the next ATS unit. The receiving unit shall accept only messages intended for it.

11.3.6 Movement messages

Movement messages shall be addressed simultaneously to the first en-route control centre, to all other ATS units along the route of flight which are unable to obtain or process current flight plan data, and to air traffic flow management units concerned.

11.3.7 Coordination and transfer data

11.3.7.1 Progression of a flight between successive control sectors and/or control centres shall be effected by a coordination and transfer dialogue comprising the following stages:

- a) notification of the flight in order to prepare for coordination as necessary;
- b) coordination of conditions of transfer of control by the transferring ATC unit;
- c) coordination, if necessary, and acceptance of conditions of transfer of control by the accepting ATC unit; and
- d) the transfer of control to the accepting unit.

11.3.7.2 Except as provided for in 11.3.7.3, the notification of the flight shall be by a current flight plan message containing all relevant ATS data or by an estimate message containing the proposed conditions of transfer. An estimate message shall be used only when updated basic flight plan data is already available at the receiving unit, i.e. a filed flight plan message and associated update message(s) have already been sent by the transferring unit.

11.3.7.3 Where AIDC messages are used, the notification of the flight shall be via a Notification message and/or Coordination Initial message containing all relevant ATS data.

11.3.7.4 Except as provided for in 11.3.7.5, the coordination dialogue shall be considered to be completed as soon as the proposed conditions contained in the current flight plan message, or in the estimate message or in one or more counterproposals, are accepted by an operational or logical procedure.

11.3.7.5 Where AIDC messages are used, any coordination dialogue shall be considered to be completed as soon as the Coordinate Initial message or a counterproposal (Coordinate Negotiate message) has been accepted.

11.3.7.6 Except as provided for in 11.3.7.7, unless an operational acknowledgement is received, a Logical Acknowledgement message shall be automatically transmitted by the receiving computer in order to ensure the integrity of the coordination dialogue employing computer-to-computer links. This message shall be transmitted when the transfer data has been received and processed to the point that it is considered free of syntactic and semantic errors, i.e. the message contains valid information.

11.3.7.7 Where AIDC messages are used, an Application Accept message shall be automatically transmitted by the receiving computer in order to ensure the integrity of the coordination dialogue employing computer-to-computer links. This message shall be transmitted when the coordination, general information or transfer data has been received, processed and found free of errors and, where relevant, is available for presentation at the control position.

11.3.7.8 The transfer of control shall be either explicit or, by agreement between the two units concerned, implicit, i.e. no communication need be exchanged between the transferring and accepting units.

11.3.7.9 When the transfer of control involves exchange of data, the proposal for transfer shall include information derived from an ATS surveillance system, if appropriate. Since the proposal relates to previously accepted coordination data, further coordination shall normally not be required. However, acceptance of the proposed transfer conditions shall be required.

11.3.7.10 In situations where the proposed transfer conditions are no longer acceptable to the accepting unit, further coordination shall be initiated by the accepting unit by proposing alternative acceptable conditions.

11.3.7.11 Transfer of Communication messages may be used as an alternative to Transfer of Control messages. If Transfer of Communication messages are used to instruct a flight to establish communications with the receiving unit and the transfer of control will take place at the control area boundary, or such other time or place, specified in letters of agreement, Transfer of Control messages need not be used.

11.3.7.12 If, after receipt of information derived from an ATS surveillance system, the accepting centre is unable to identify the aircraft immediately, additional communication shall ensue to obtain new surveillance information, if appropriate.

11.3.7.13 When control of the transferred aircraft has been assumed, the accepting unit shall complete the transfer of control dialogue by communicating assumption of control to the transferring unit, unless special arrangements have been made between the units concerned.

11.3.8 Supplementary data

11.3.8.1 When basic flight plan data or supplementary flight plan data are required, request messages shall be addressed to the ATS unit which is most likely to have access to the required data.

Note.— See 11.4.2.4.2 and 11.4.2.4.3 for ATS units to which request messages shall be addressed.

11.3.8.2 If the requested information is available, a filed or a supplementary flight plan message shall be transmitted.

11.4 MESSAGE TYPES AND THEIR APPLICATION

11.4.1 Emergency messages

11.4.1.1 The various circumstances surrounding each known or suspected emergency situation preclude the specification of standard message types to provide for emergency communications, except as described in 11.4.1.2, 11.4.1.3 and 11.4.1.4.

11.4.1.2 ALERTING (ALR) MESSAGES

11.4.1.2.1 When an ATS unit considers that an aircraft is in a state of emergency as defined in Annex 11, Chapter 5, an alerting message shall be transmitted to any ATS unit that may be concerned with the flight and to the associated rescue coordination centres, containing such of the information specified in Appendix 3, Section 1, as is available or can be obtained.

11.4.1.2.2 When so agreed between the ATS units concerned, a communication relating to an emergency phase and originated by a unit employing automatic data-processing equipment may take the form of a modification message (as in 11.4.2.2.4) or a coordination message (as in 11.4.2.3.4 or 11.4.2.4.4), supplemented by a verbal message giving the additional details prescribed for inclusion in an alerting message.

11.4.1.3 RADIOCOMMUNICATION FAILURE (RCF) MESSAGES

Note.— Provisions governing the action to be taken in the event of radiocommunication failure are set forth in Annex 2, 3.6.5.2, and in Chapter 15, Section 15.6 of this document.

11.4.1.3.1 When an ATS unit is aware that an aircraft in its area is experiencing radiocommunication failure, an RCF message shall be transmitted to all subsequent ATS units along the route of flight which have already received basic flight plan data (FPL or RPL) and to the aerodrome control tower at the destination aerodrome, if basic flight plan data has been previously sent.

11.4.1.3.2 If the next ATS unit has not yet received basic flight plan data because it would receive a current flight plan message in the coordination procedure, then an RCF message and a current flight plan (CPL) message shall be transmitted to this ATS unit. In turn, this ATS unit shall transmit an RCF message and a CPL message to the next ATS unit.

11.4.1.4 FREE TEXT EMERGENCY MESSAGES (AIDC, APPENDIX 6 REFERS)

11.4.1.4.1 Whenever operational information needs to be transmitted concerning an aircraft known or believed to be in a state of emergency and the information cannot be formatted to comply with any other AIDC message type, a free text emergency message shall be sent.

11.4.1.4.2 The following are some examples of circumstances which could justify the use of a free text emergency message:

- a) reports of emergency calls or emergency locator transmission reports;
- b) messages concerning unlawful interference or bomb warnings;
- c) messages concerning serious illness or disturbance among passengers;
- d) sudden alteration in flight profile due to technical or navigational failure; and
- e) communication failure.

11.4.2 Movement and control messages

11.4.2.1 GENERAL

Messages concerning the intended or actual movement of aircraft shall be based on the latest information furnished to ATS units by the pilot, the operator or its designated representative, or derived from an ATS surveillance system.

11.4.2.2 MOVEMENT MESSAGES

11.4.2.2.1 Movement messages comprise:

- filed flight plan messages (11.4.2.2.2)
- delay messages (11.4.2.2.3)
- modification messages (11.4.2.2.4)
- flight plan cancellation messages (11.4.2.2.5)
- departure messages (11.4.2.2.6)
- arrival messages (11.4.2.2.7).

11.4.2.2.2 FILED FLIGHT PLAN (FPL) MESSAGES

Note.— Instructions for the transmission of an FPL message are contained in Appendix 2.

11.4.2.2.2.1 Unless repetitive flight plan procedures are being applied or current flight plan messages are being employed, filed flight plan messages shall be transmitted for all flights for which a flight plan has been submitted with the object of being provided with air traffic control service, flight information service or alerting service along part or the whole of the route of flight.

11.4.2.2.2.2 A filed flight plan message shall be originated and addressed as follows by the ATS unit serving the departure aerodrome or, when applicable, by the ATS unit receiving a flight plan from an aircraft in flight:

- a) an FPL message shall be sent to the ACC or flight information centre serving the control area or FIR within which the departure aerodrome is situated;
- b) unless basic flight plan data are already available as a result of arrangements made for repetitive flight plans, an FPL message shall be sent to all centres in charge of each FIR or upper FIR along the route which are unable to process current data. In addition, an FPL message shall be sent to the aerodrome control tower at the destination aerodrome. If so required, an FPL message shall also be sent to flow management centres responsible for ATS units along the route;
- c) when a potential re-clearance in flight (RIF) request is indicated in the flight plan, the FPL message shall be sent to the additional centres concerned and to the aerodrome control tower of the revised destination aerodrome;
- d) where it has been agreed to use CPL messages but where information is required for early planning of traffic flow, an FPL message shall be transmitted to the ACCs concerned;
- e) for a flight along routes where flight information service and alerting service only are provided, an FPL message shall be addressed to the centre in charge of each FIR or upper FIR along the route and to the aerodrome control tower at the destination aerodrome.

11.4.2.2.2.3 In the case of a flight through intermediate stops, where flight plans for each stage of the flight are filed at the first departure aerodrome, the following procedure shall be applied:

- a) the air traffic services reporting office at the first departure aerodrome shall:
 - 1) transmit an FPL message for the first stage of flight in accordance with 11.4.2.2.2.2;
 - 2) transmit a separate FPL message for each subsequent stage of flight, addressed to the air traffic services reporting office at the appropriate subsequent departure aerodrome;

- b) the air traffic services reporting office at each subsequent departure aerodrome shall take action on receipt of the FPL message as if the flight plan has been filed locally.

11.4.2.2.2.4 When so required by agreement between the appropriate ATS authorities to assist in the identification of flights and thereby eliminate or reduce the need for interceptions in the event of deviations from assigned track, FPL messages for flights along specified routes or portions of routes in close proximity to FIR boundaries shall also be addressed to the centres in charge of each FIR or upper FIR adjacent to such routes or portions of routes.

11.4.2.2.2.5 FPL messages should be transmitted immediately after the filing of the flight plan. If a flight plan is filed more than 24 hours in advance of the estimated off-block time of the flight to which it refers, the date of the flight departure shall be inserted in Item 18 of the flight plan.

11.4.2.2.3 DELAY (DLA) MESSAGES

11.4.2.2.3.1 A DLA message shall be transmitted when the departure of an aircraft, for which basic flight plan data (FPL or RPL) has been sent, is delayed by more than 30 minutes after the estimated off-block time contained in the basic flight plan data.

11.4.2.2.3.2 The DLA message shall be transmitted by the ATS unit serving the departure aerodrome to all recipients of basic flight plan data.

Note.— See 11.4.2.3.4 concerning notification of a delayed departure of an aircraft for which a CPL message has been transmitted.

11.4.2.2.4 MODIFICATION (CHG) MESSAGES

A CHG message shall be transmitted when any change is to be made to basic flight plan data contained in previously transmitted FPL or RPL data. The CHG message shall be sent to those recipients of basic flight plan data which are affected by the change. Relevant revised basic flight plan data shall be provided to such affected entities not previously having received this.

Note.— See 11.4.2.3.4 concerning notification of a change to coordination data contained in a previously transmitted current flight plan or estimate message.

11.4.2.2.5 FLIGHT PLAN CANCELLATION (CNL) MESSAGES

A flight plan cancellation (CNL) message shall be transmitted when a flight, for which basic flight plan data has been previously distributed, has been cancelled. The ATS unit serving the departure aerodrome shall transmit the CNL message to ATS units which have received basic flight plan data.

11.4.2.2.6 DEPARTURE (DEP) MESSAGES

11.4.2.2.6.1 Unless otherwise prescribed on the basis of regional air navigation agreements, a DEP message shall be transmitted immediately after the departure of an aircraft for which basic flight plan data have been previously distributed.

11.4.2.2.6.2 The DEP message shall be transmitted by the ATS unit serving the departure aerodrome to all recipients of basic flight plan data.

Note.— See 11.4.2.3.4 concerning notification of the departure of an aircraft for which a CPL message has been transmitted.

11.4.2.2.7 ARRIVAL (ARR) MESSAGES

11.4.2.2.7.1 When an arrival report is received by the ATS unit serving the arrival aerodrome, this unit shall transmit an ARR message:

- a) for a landing at the destination aerodrome:
 - 1) to the ACC or flight information centre in whose area the arrival aerodrome is located, if required by that unit; and
 - 2) to the ATS unit, at the departure aerodrome, which originated the flight plan message, if that message included a request for an ARR message;
- b) for a landing at an alternate or other aerodrome:
 - 1) to the ACC or flight information centre in whose area the arrival aerodrome is located; and
 - 2) to the aerodrome control tower at the destination aerodrome; and
 - 3) to the air traffic services reporting office at the departure aerodrome; and
 - 4) to the ACC or flight information centre in charge of each FIR or upper FIR through which the aircraft would have passed according to the flight plan, had it not diverted.

11.4.2.2.7.2 When a controlled flight which has experienced failure of two-way communication has landed, the aerodrome control tower at the arrival aerodrome shall transmit an ARR message:

- a) for a landing at the destination aerodrome:
 - 1) to all ATS units concerned with the flight during the period of the communication failure; and
 - 2) to all other ATS units which may have been alerted;
- b) for a landing at an aerodrome other than the destination aerodrome:

to the ATS unit serving the destination aerodrome; this unit shall then transmit an ARR message to other ATS units concerned or alerted as in a) above.

11.4.2.3 COORDINATION MESSAGES (APPENDIX 3 REFERS)

Note.— The provisions governing coordination are contained in Chapter 10. Phraseology to be used in voice communication is contained in Chapter 12. See paragraph 11.4.2.5 below for the provisions governing AIDC messages, as prescribed in Appendix 6.

11.4.2.3.1 Coordination messages comprise:

- current flight plan messages (11.4.2.3.2)

- estimate messages (11.4.2.3.3)
- coordination messages (11.4.2.3.4)
- acceptance messages (11.4.2.3.5)
- logical acknowledgement messages (11.4.2.3.6).

11.4.2.3.2 *CURRENT FLIGHT PLAN (CPL) MESSAGES*

11.4.2.3.2.1 Unless basic flight plan data have already been distributed (FPL or RPL) which will be supplemented by coordination data in the estimate message, a CPL message shall be transmitted by each ACC to the next ACC and from the last ACC to the aerodrome control tower at the destination aerodrome, for each controlled flight, and for each flight provided with air traffic advisory service along routes or portions of routes where it has been determined by the appropriate ATS authority that adequate point-to-point communications exist and that conditions are otherwise suitable for forwarding current flight plan information.

11.4.2.3.2.2 When an aircraft traverses a very limited portion of a control area where, by agreement between the appropriate ATS authorities concerned, coordination of air traffic through that portion of the control area has been delegated to and is effected directly by the two centres whose control areas are separated by that portion, CPLs shall be transmitted directly between such units.

11.4.2.3.2.3 A CPL message shall be transmitted in sufficient time to permit each ATS unit concerned to receive the information at least 20 minutes before the time at which the aircraft is estimated to pass the transfer of control point or boundary point at which it comes under the control of such unit, unless another period of time has been prescribed by the appropriate ATS authority. This procedure shall apply whether or not the ATS unit responsible for origination of the message has assumed control of, or established contact with, the aircraft by the time the transmission is to be effected.

11.4.2.3.2.4 When a CPL message is transmitted to a centre which is not using automatic data-processing equipment, the period of time specified in 11.4.2.3.2.3 may be insufficient, in which case an increased lead-time shall be agreed.

11.4.2.3.2.5 A CPL message shall include only information concerning the flight from the point of entry into the next control area or advisory airspace to the destination aerodrome.

11.4.2.3.3 *ESTIMATE (EST) MESSAGES*

11.4.2.3.3.1 When basic flight plan data for a flight has been provided, an EST message shall be transmitted by each ACC or flight information centre to the next ACC or flight information centre along the route of flight.

11.4.2.3.3.2 An EST message shall be transmitted in sufficient time to permit the ATS unit concerned to receive the information at least 20 minutes before the time at which the aircraft is estimated to pass the transfer of control point or boundary point at which it comes under the control of such unit, unless another period of time has been prescribed by the appropriate ATS authority. This procedure shall apply whether or not the ACC or flight information centre responsible for origination of the message has assumed control of, or established contact with, the aircraft by the time the transmission is to be effected.

11.4.2.3.3.3 When an EST message is transmitted to a centre which is not using automatic data-processing equipment, the period of time specified in 11.4.2.3.3.2 may be insufficient, in which case an increased lead-time shall be agreed.

11.4.2.3.4 *COORDINATION (CDN) MESSAGES*

11.4.2.3.4.1 A CDN message shall be transmitted during the coordination dialogue by an accepting unit to the transferring unit when the former wishes to propose a change to coordination data as contained in a previously received CPL or EST message.

11.4.2.3.4.2 If the transferring unit wishes to propose a change to the data contained in a CDN message received from the accepting unit, a CDN message shall be transmitted to the accepting unit.

11.4.2.3.4.3 The dialogue described above is repeated until the coordination dialogue is completed by the transmission of an acceptance (ACP) message by one of the two units concerned. Normally, however, when a change is proposed to a CDN message, direct-speech circuits shall be used to resolve this issue.

11.4.2.3.4.4 After the coordination dialogue has been completed, if one of the two ATS units concerned wishes to propose or notify any change in basic flight plan data or conditions of transfer, a CDN message shall be transmitted to the other unit. This requires that the coordination dialogue be repeated.

11.4.2.3.4.5 A repeated coordination dialogue is completed by the transmission of an ACP message. Normally, in a repeated coordination dialogue, direct-speech circuits shall be used.

11.4.2.3.5 ACCEPTANCE (ACP) MESSAGES

11.4.2.3.5.1 Unless special arrangements have been made between the air traffic control units concerned in accordance with Chapter 10, 10.1.2.2.1, an ACP message shall be transmitted by an accepting unit to the transferring unit to indicate that data in a CPL or an EST message is accepted.

11.4.2.3.5.2 Either the accepting unit or the transferring unit shall transmit an ACP message to indicate that data received in a CDN message is accepted and that the coordination dialogue is completed.

11.4.2.3.6 LOGICAL ACKNOWLEDGEMENT MESSAGES (LAM)

11.4.2.3.6.1 An LAM shall be used only between ATC computers.

11.4.2.3.6.2 An ATC computer shall transmit an LAM in response to a CPL or EST or other appropriate message which is received and processed up to the point where the operational content will be received by the appropriate controller.

11.4.2.3.6.3 The transferring centre shall set an appropriate reaction time parameter when the CPL or EST message is transmitted. If the LAM is not received within the parameter time, an operational warning shall be initiated and reversion to telephone and manual mode shall ensue.

11.4.2.4 SUPPLEMENTARY MESSAGES

11.4.2.4.1 Supplementary messages comprise:

- request flight plan messages (11.4.2.4.2)
- request supplementary flight plan messages (11.4.2.4.3)
- supplementary flight plan messages (11.4.2.4.4).

11.4.2.4.2 REQUEST FLIGHT PLAN (RQP) MESSAGES

A request flight plan (RQP) message shall be transmitted when an ATS unit wishes to obtain flight plan data. This might occur upon receipt of a message concerning an aircraft for which no corresponding basic flight plan data had been previously received. The RQP message shall be transmitted to the transferring ATS unit which originated an EST message, or to the centre which originated an update message for which no corresponding basic flight plan data are available. If no message has been received at all, but an aircraft establishes radiotelephony (RTF) communications and requires air traffic services, the RQP message shall be transmitted to the previous ATS unit along the route of flight.

11.4.2.4.3 *REQUEST SUPPLEMENTARY FLIGHT PLAN (RQS) MESSAGES*

A request supplementary flight plan (RQS) message shall be transmitted when an ATS unit wishes to obtain supplementary flight plan data. The message shall be transmitted to the air traffic services reporting office at the departure aerodrome or in the case of a flight plan submitted during flight, to the ATS unit specified in the flight plan message.

11.4.2.4.4 *SUPPLEMENTARY FLIGHT PLAN (SPL) MESSAGES*

Note.— *Instructions for the transmission of an SPL are contained in Appendix 2.*

An SPL message shall be transmitted by the ATS reporting office at the departure aerodrome to ATS units requesting information additional to that already transmitted in a CPL or FPL message. When transmitted by the AFTN, the message shall be assigned the same priority indicator as that in the request message.

11.4.2.5 AIDC MESSAGES (APPENDIX 6 REFERS)

11.4.2.5.1 AIDC messages comprise:

- Notify messages (11.4.2.5.3)
- Coordinate Initial messages (11.4.2.5.4)
- Coordinate Negotiate messages (11.4.2.5.5)
- Coordinate Accept messages (11.4.2.5.6)
- Coordinate Reject messages (11.4.2.5.7)
- Coordinate Cancel messages (11.4.2.5.8)
- Coordinate Update messages (11.4.2.5.9)
- Coordinate Standby messages (11.4.2.5.10)
- Transfer Initiate messages (11.4.2.5.11)
- Transfer Conditions Proposal messages (11.4.2.5.12)
- Transfer Conditions Accept messages (11.4.2.5.13)
- Transfer Communication Request messages (11.4.2.5.14)
- Transfer Communication messages (11.4.2.5.15)
- Transfer Communication Assume messages (11.4.2.5.16)
- Transfer Control messages (11.4.2.5.17)
- Transfer Control Assume messages (11.4.2.5.18)
- General Point messages (11.4.2.5.19)
- General Executive Data messages (11.4.2.5.20)
- Free Text Emergency messages (11.4.1.4)
- Free Text General messages (11.4.2.5.21)
- Application Accept messages (11.4.2.5.22)
- Application Reject messages (11.4.2.5.23).

11.4.2.5.2 The requirements with regard to the selection of AIDC messages and the associated procedures should be established on the basis of regional air navigation agreements in order to facilitate the harmonization of ATS in adjacent airspaces.

Note.— *While the implementation of AIDC messages is intended to automate the ATC coordination process and minimize the requirement for voice coordination, it is not a complete replacement for voice, especially when a flight is in close proximity to the boundary with an adjoining unit.*

11.4.2.5.3 NOTIFY MESSAGES

11.4.2.5.3.1 Notify messages shall be transmitted in advance to the ATS unit(s) for which coordination for the flight will be required. This could include ATS units that may be affected by the flight's trajectory even though the flight may not actually enter the airspace of these ATS units. The initial Notify message shall be sent at or prior to an agreed time or distance before the common boundary with the receiving unit. This time or distance shall normally occur prior to the transmission of the initial coordination message. If an aircraft is departing an aerodrome close to the common boundary, however, adjacent units may agree that no Notify message is required and that a Coordinate Initial message will suffice.

11.4.2.5.3.2 All Notify messages shall include boundary estimate data. Route data, when included, shall as a minimum contain information from a point prior to entry into the receiving unit to the destination aerodrome.

Note 1.— The amount of route information prior to the point of entry into the airspace of the receiving units depends on the environment of the flight. Typically, more route information would be required in a procedural environment.

Note 2.— To permit the synchronization of flight data information with adjacent units, the initial Notify message may contain all flight plan data associated with the flight.

11.4.2.5.3.3 Prior to the transmission of the Coordinate Initial message, amendments to the contents of a previously transmitted Notify message shall be communicated by transmission of another Notify message containing the amended data. Amendments to the level, route or destination aerodrome, may also necessitate a change to the ATS units to which the new Notify message is sent.

11.4.2.5.3.4 If the destination of an aircraft is amended prior to the transmission of the initial Notify message, the destination aerodrome in the Notify message shall contain the amended destination. If the destination is amended after the transmission of the initial Notify message but prior to the transmission of the Coordinate Initial message, a new Notify message shall be transmitted containing the original destination in the destination aerodrome data, and the new destination as the amended destination. Subsequent AIDC messages to the same unit shall contain only the amended destination in the destination aerodrome data.

11.4.2.5.3.5 There is no operational response to a Notify message.

11.4.2.5.4 COORDINATE INITIAL MESSAGES

11.4.2.5.4.1 A Coordinate Initial message shall be transmitted by each area control centre to the next area control centre and from the last area control centre to the approach control unit serving the destination aerodrome (or aerodrome control if such a unit does not exist), for each controlled flight, and for each flight provided with air traffic advisory service, along routes or portions of routes where it has been determined by the appropriate ATS authority that conditions are suitable for forwarding coordination information. This may include ATS units that will be affected by the flight's trajectory even though the flight may not actually enter the airspace of these ATS units.

11.4.2.5.4.2 The Coordinate Initial message constitutes a proposal for coordination of a flight in accordance with the information contained in the coordination message and any previously received notification message(s) (if applicable). All Coordinate Initial messages shall include boundary estimate data. Route data, when included, shall as a minimum contain information from a point prior to entry into the next unit to the destination aerodrome.

Note 1.— The amount of route information prior to the point of entry into the airspace of the receiving ATS units depends on the environment of the flight. Typically, more route information would be required in a procedural environment.

Note 2.— To permit the synchronization of flight data information with adjacent units if a Notify message has not been previously transmitted, the Coordinate Initial message may contain all flight plan data associated with the flight.

11.4.2.5.4.3 When an aircraft traverses a very limited portion of a control area where, by agreement between the appropriate ATS authorities, coordination of air traffic through that portion of the control area has been delegated to, and is effected directly between, the two units whose control areas are separated by that portion, Coordinate Initial messages shall be transmitted directly between such units, in addition to the ATS unit whose airspace is being traversed.

11.4.2.5.4.4 A Coordinate Initial message shall be transmitted in sufficient time to permit each ATS unit concerned to receive the information at least 20 minutes before the time at which the aircraft is estimated to pass the transfer of control point or boundary point with the receiving unit, unless another period of time has been prescribed by the appropriate ATS authority. This requirement shall apply whether or not the ATS unit responsible for origination of the Coordinate Initial message has assumed control of, or established contact with, the aircraft by the time the coordination is to be effected.

11.4.2.5.4.5 When a Coordinate Initial message is transmitted to an ATS unit which is not using automatic data-processing equipment, the period of time specified in 11.4.2.5.4.4 may be insufficient, in which case an increased time parameter may be agreed upon.

11.4.2.5.4.6 The standard responses to a Coordinate Initial message are either a Coordinate Negotiate or a Coordinate Accept message. However, if a Coordinate Initial message is received proposing non-standard coordination conditions and the Coordinate Negotiate message is not an appropriate response, the Coordinate Reject message may be used to reject the Coordinate Initial message. If this occurs, local procedures shall prescribe the requirements to complete the coordination process.

11.4.2.5.5 COORDINATE NEGOTIATE MESSAGES

11.4.2.5.5.1 A Coordinate Negotiate message shall be transmitted by the receiving unit to the transferring unit during the initial coordination dialogue when the receiving unit wishes to propose an amendment to the coordination conditions contained in the Coordinate Initial message.

11.4.2.5.5.2 Normally, when further negotiation is required in response to a Coordinate Negotiate message received during the initial coordination dialogue, direct-speech circuits shall be used to resolve the issue. However, where so agreed between the two units, a Coordinate Negotiate message shall be transmitted in response. This message exchange is repeated until the coordination dialogue is completed by the transmission of a Coordinate Accept message by one of the units.

11.4.2.5.5.3 A Coordinate Negotiate message shall be transmitted after successful completion of coordination by either the transferring or receiving unit to propose an amendment to the previously agreed coordination conditions. The Coordinate Negotiate message is sent if the amendments are not in accordance with letters of agreement between the transferring and receiving units, or if Coordinate Update messages are not in use.

11.4.2.5.5.4 A Coordinate Negotiate message would not normally be transmitted after the transition to the transfer state has commenced. However, where so agreed between ATS units, a Coordinate Negotiate message shall be transmitted by the receiving ATS unit to propose a modification to the flight details after the transfer of control of the flight has been completed, but when the flight is still within proximity of the boundary between the two ATS units.

11.4.2.5.5.5 Normally, when a further change is required in response to a Coordinate Negotiate message received after the initial coordination has been successfully completed, direct-speech circuits shall be used to resolve the issue. However, where so agreed between ATS units, a Coordinate Negotiate message may be transmitted in response. This

message exchange is repeated until the negotiation dialogue is completed by the transmission of either a Coordinate Accept or Coordinate Reject message by one of the units.

11.4.2.5.5.6 If a Coordinate Negotiate message is used to propose an amendment to the destination aerodrome, the Coordinate Negotiate message shall contain the original destination in the destination aerodrome data, and the new destination as the amended destination. The operational response to this Coordinate Negotiate message shall also contain the original destination in the destination aerodrome data. Provided that the amendment is accepted, subsequent AIDC messages to the same unit shall refer only to the amended destination in the destination aerodrome data.

11.4.2.5.5.7 All Coordinate Negotiate messages shall contain boundary estimate data. When agreed between the two units, a Coordinate Negotiate message shall be sent to update other flight plan data such as CNS equipment and other information. Route data, when included due to a new route needing to be coordinated, shall as a minimum contain information from a point prior to entry into the next unit to the point where the new route rejoins the previously coordinated route.

11.4.2.5.5.8 A Coordinate Negotiate message would normally be presented to the controller for manual processing.

11.4.2.5.6 COORDINATE ACCEPT MESSAGES

11.4.2.5.6.1 A Coordinate Accept message shall be transmitted by the ATS unit receiving a Coordinate Initial, Coordinate Update or Coordinate Negotiate message to indicate that the proposed coordination conditions (or revision thereto) contained in the received message are accepted.

11.4.2.5.6.2 When a Coordinate Accept message is transmitted in response to a negotiation dialogue proposing an amendment to the destination aerodrome, the Coordinate Accept message may (optionally) contain the previous destination in the destination aerodrome data.

Note.— The use of the previous destination in the destination aerodrome data of the Coordinate Accept message may be required to ensure the proper association with the Coordinate Negotiate message proposing the amendment of the destination aerodrome.

11.4.2.5.6.3 The Coordinate Accept message terminates the coordination or negotiation dialogue. There is no operational response to a Coordinate Accept message.

11.4.2.5.7 COORDINATE REJECT MESSAGES

11.4.2.5.7.1 When agreed between the two units, a Coordinate Reject message may be used to reject the coordination conditions proposed in a Coordinate Initial message if these coordination conditions are not in accordance with letters of agreement. The Coordinate Reject message may only be used as a response to a Coordinate Initial message provided that local procedures exist to complete the coordination of the flight.

11.4.2.5.7.2 A Coordinate Reject message shall be transmitted by the ATS unit receiving a Coordinate Update or Coordinate Negotiate message to indicate that the proposed revision to coordination conditions contained in the received message are not acceptable and that no counterproposal will be made by the use of a Coordinate Negotiate message.

11.4.2.5.7.3 When a Coordinate Reject message is transmitted in response to a negotiation dialogue proposing an amendment to the aerodrome, the Coordinate Reject message may (optionally) contain the previous destination in the destination aerodrome data.

Note.— The use of the previous destination in the destination aerodrome data of the Coordinate Reject message may be required to ensure the proper association with the Coordinate Negotiate message proposing the amendment of the destination aerodrome.

11.4.2.5.7.4 A Coordinate Reject message terminates the coordination or negotiation dialogue. If the Coordinate Reject was a response to a negotiation dialogue after coordination had been completed, any previously agreed coordination conditions remain valid. There is no operational response to a Coordinate Reject message.

11.4.2.5.8 COORDINATE CANCEL MESSAGES

11.4.2.5.8.1 A Coordinate Cancel message shall be transmitted by the transferring unit to the receiving unit to abrogate the existing notification or coordination of a flight in the event that it is delayed indefinitely or the route or level is amended such that the flight is no longer expected to enter the airspace of the receiving unit directly from that of the transferring unit. If the amendments to the route or level of the flight are such that it will now affect another unit the transmission of an initial Notify message and/or Coordinate Initial message to that unit may be required.

11.4.2.5.8.2 The Coordinate Cancel message may include information regarding the reason for the cancellation. This information is defined in the *Manual of Air Traffic Services Data Link Applications* (Doc 9694).

11.4.2.5.8.3 There is no operational response to a Coordinate Cancel message.

11.4.2.5.9 COORDINATE UPDATE MESSAGES

11.4.2.5.9.1 A Coordinate Update message shall be transmitted by the transferring unit to the receiving unit to propose an amendment to the previously agreed coordination conditions, provided that the proposed amendment is in accordance with letters of agreement. If the amendment is not in accordance with letters of agreement, a Coordinate Negotiate message shall be used instead. A Coordinate Update message shall not be transmitted before coordination has been successfully completed, or after the transition to the transfer state has commenced.

11.4.2.5.9.2 If the flight is greater than an agreed time or distance prior to the boundary, amendments contained in a Coordinate Update message are automatically processed by the receiving unit, and a Coordinate Accept message is transmitted automatically in response. If the flight is within this agreed time or distance prior to the boundary, a Coordinate Negotiate message shall be used.

11.4.2.5.9.3 If a Coordinate Update message is used to propose an amendment to the destination aerodrome, the Coordinate Update message shall contain the original destination in the destination aerodrome data, and the new destination as the amended destination. The operational response to this Coordinate Update message shall also contain the original destination in the destination aerodrome data. Provided that the amendment is accepted, subsequent AIDC messages to the same unit shall contain only the amended destination in the destination aerodrome data.

11.4.2.5.9.4 All Coordinate Update messages shall contain boundary estimate data. When agreed between the two units, a Coordinate Update message shall be sent to update other flight plan data such as CNS equipment and other information. Route data, when included due to a new route needing to be coordinated, shall as a minimum contain information from a point prior to entry into the next unit to the point where the new route rejoins the previously coordinated route.

11.4.2.5.10 COORDINATE STANDBY MESSAGES

The Coordinate Standby message shall be sent by the unit receiving a Coordinate Initial or Coordinate Negotiate message to indicate to the sending unit that their proposal has been received and will be responded to in due course. It could be used for example, if the coordination message had to be referred for manual processing or if further coordination had to be conducted with another unit.

11.4.2.5.11 TRANSFER INITIATE MESSAGES

11.4.2.5.11.1 The transfer of control and communication messages that are to be used in a specific ATC environment shall be agreed between the units concerned and should be agreed on a regional basis. The messages used in a high density continental environment will be different from those required in a low density remote airspace environment.

11.4.2.5.11.2 The Transfer Initiate message shall be transmitted automatically by the transferring unit at or prior to an agreed time or distance before the common boundary. This message, initiating the transfer phase, shall be sent only after coordination has been successfully completed with the receiving unit.

11.4.2.5.11.3 The Transfer Initiate message contains all executive data and may optionally include any track data relating to the flight. This information updates the receiving unit with the current control environment of the flight, e.g. current cleared flight level and any speed restrictions, rate of climb or descent, heading or direct routing that may have been assigned.

11.4.2.5.11.4 The Transfer Initiate message alleviates the requirement for the controller in the transferring unit to verbally provide this information to the controller in the receiving unit while also allowing the automatic update of the flight data held by the receiving unit.

11.4.2.5.11.5 There is no operational response to a Transfer Initiate message.

11.4.2.5.12 TRANSFER CONDITIONS PROPOSAL MESSAGES

11.4.2.5.12.1 The Transfer Conditions Proposal message shall be used to manually transfer a flight early, or under conditions that are not in accordance with those specified in the applicable letter of agreement (e.g. assigned speed greater than that agreed to in the letter of agreement, aircraft on heading). If a Transfer Initiate message had not previously been sent, the Transfer Conditions Proposal message initiates the transfer phase, and the transmission of the Transfer Initiate message is not required.

11.4.2.5.12.2 Subsequent amendments to the control environment of the flight are coordinated by the transmission of another Transfer Conditions Proposal message containing new executive data to the receiving unit.

11.4.2.5.12.3 The Transfer Conditions Proposal message proposes the transfer of communication and control of the flight to the controller in the accepting unit, together with updated control environment data. The message should be referred to the controller in the receiving unit for manual processing.

Note.— The terms of the transfer of control contained in the relevant letter of agreement may restrict control of the aircraft until the aircraft has reached the transfer of control point.

11.4.2.5.12.4 The operational response to a Transfer Conditions Proposal is a Transfer Conditions Accept message.

11.4.2.5.13 *TRANSFER CONDITIONS ACCEPT MESSAGES*

11.4.2.5.13.1 The Transfer Conditions Accept message is transmitted by the accepting unit to indicate that the controller has agreed to accept the transfer of communication and control of the flight in accordance with the conditions proposed in the Transfer Conditions Proposal message.

11.4.2.5.13.2 Where required, the Transfer Conditions Accept message shall include the radiotelephony frequency(ies) or channel(s) as appropriate that the flight is to be transferred to.

11.4.2.5.13.3 There is no operational response to a Transfer Conditions Accept message.

11.4.2.5.14 *TRANSFER COMMUNICATION REQUEST MESSAGES*

11.4.2.5.14.1 The Transfer Communication Request message shall be transmitted by the controller in the accepting unit to request the transfer of communication of a flight. The message shall be used when the controller in the accepting unit requires communication with the flight forthwith and indicates that the controller in the transferring unit should transmit appropriate contact instructions to the relevant aircraft. Where required, the Transfer Communication Request message shall include the radiotelephony frequency(ies) or channel(s) as appropriate that the flight is to be transferred to.

11.4.2.5.14.2 There is no operational response required for the Transfer Communication Request message, but receipt of this message would normally result in a Transfer Communication message being transmitted by the transferring unit when the flight is instructed to contact the receiving unit.

11.4.2.5.15 *TRANSFER COMMUNICATION MESSAGES*

The Transfer Communication message shall indicate that the controller in the transferring unit has instructed the flight to establish communication with the controller in the accepting unit. On receipt of this message the controller in the receiving unit shall ensure that communication is established shortly thereafter. The Transfer Communication message may optionally include any “release conditions” for the transfer of control. These release conditions may include climb, descent or turn restrictions, or a combination thereof. If a Transfer Initiate message has not been previously sent, the Transfer Communication message initiates the transfer phase.

11.4.2.5.16 *TRANSFER COMMUNICATION ASSUME MESSAGES*

The Transfer Communication Assume message shall be transmitted by the accepting unit to indicate that the flight has established communications with the appropriate controller and completes the transfer.

11.4.2.5.17 *TRANSFER CONTROL MESSAGES*

11.4.2.5.17.1 The Transfer Control message is a proposal for the transfer of control of a flight to the accepting unit. This message shall be transmitted either automatically by the transferring unit at, or prior to, an agreed time or distance before the common boundary, or manually by the controller in the transferring unit. This message, initiating the transfer phase, shall be transmitted only after coordination has been successfully completed with the receiving unit.

11.4.2.5.17.2 The operational response to a Transfer Control message is a Transfer Control Assume message.

11.4.2.5.18 *TRANSFER CONTROL ASSUME MESSAGES*

The Transfer Control Assume message shall indicate that the controller in the accepting unit has accepted control responsibility for the flight. The receipt of this message completes the transfer of control process.

11.4.2.5.19 *GENERAL POINT MESSAGES*

The General Point message shall be transmitted to draw the attention of the controller receiving the message to a flight to support voice coordination. The General Point message shall include details of a flight that may have been previously unknown to the receiving unit, to permit it to be displayed if required. This may include, for example, a flight that had planned to operate in airspace under the control of one ATS unit requesting climb or diversion into airspace controlled by another ATS unit which has no details of the flight.

11.4.2.5.20 *GENERAL EXECUTIVE DATA MESSAGES*

11.4.2.5.20.1 The General Executive Data message shall be sent after the transition to the transfer state has commenced and prior to the Transfer Control Assume or Transfer Communication Assume messages, either by the transferring unit to the receiving unit or from the receiving unit to the transferring unit, to inform the unit receiving the message of any modification to data relating to the control environment of a flight. If the General Executive Data message is sent by the transferring unit, it may include information such as the current cleared (intermediate) flight level and, if applicable, speed restrictions, climb/descent restrictions and the heading (or direct routing) assigned to the flight. If the General Executive Data message is sent by the receiving unit, it includes the radiotelephony frequency or channel as appropriate to which the flight is to be transferred.

11.4.2.5.20.2 There is no operational response required for the General Executive Data message.

11.4.2.5.21 *FREE TEXT GENERAL MESSAGES*

Note.— See 11.4.1.4 for details on Free Text Emergency messages.

The Free Text General message shall only be used to transmit operational information for which any other message type is not appropriate, and for plain-language statements. Normally free text information would be presented directly to the controller responsible — or expecting to be responsible — for the flight. When the message does not refer to a specific flight, a facility designation shall be used to allow for the information to be presented to the appropriate ATS position.

11.4.2.5.22 *APPLICATION ACCEPT MESSAGES*

Except for another application management message, or a message within which an error has been detected, the Application Accept message shall be sent by an ATS unit receiving an AIDC message that has been processed, found free of errors and is available for presentation to a control position.

11.4.2.5.23 *APPLICATION REJECT MESSAGES*

11.4.2.5.23.1 The Application Reject message shall be sent by an ATS unit receiving an AIDC message within which an error has been detected. The Application Reject message shall include a code that enables identification of the nature of the error. Regional air navigation agreement shall be the basis for specifying the codes that are available to be implemented.

Note.— Information concerning the available ATN application reject codes can be found in the Manual of Technical Provisions for the Aeronautical Telecommunication Network (ATN) (Doc 9705), Volume III, 3.2.7.1.1.

11.4.2.5.23.2 When Application Reject messages are not in use, local procedures shall ensure that the appropriate controller is alerted within a specified time parameter where no Application Accept message has been received in response to a transmitted AIDC message.

11.4.2.6 CONTROL MESSAGES

11.4.2.6.1 Control messages comprise:

- clearance messages (11.4.2.6.2)
- flow control messages (11.4.2.6.3)
- position-report and air-report messages (11.4.2.6.4).

11.4.2.6.2 CLEARANCE MESSAGES

Note.— Provisions governing clearances are contained in Chapter 4, Section 4.5. The following paragraphs set forth the contents of clearance messages together with certain procedures relating to the transmission thereof. Procedures governing the use of CPDLC for the delivery of clearances are contained in Chapter 14. Specifications regarding the intent, message attributes and display options can be found in Chapter 14, Table 14-1 to Table 14-3 and Appendix 5.

11.4.2.6.2.1 Clearances shall contain the following in the order listed:

- a) aircraft identification;
- b) clearance limit;
- c) route of flight;
- d) level(s) of flight for the entire route or part thereof and changes of levels if required;

Note.— If the clearance for the levels covers only part of the route, it is important for the air traffic control unit to specify a point to which the part of the clearance regarding levels applies whenever necessary to ensure compliance with 3.6.5.2.2 a) of Annex 2.

- e) any necessary instructions or information on other matters such as SSR transponder operation, approach or departure manoeuvres, communications and the time of expiry of the clearance.

Note.— The time of expiry of the clearance indicates the time after which the clearance will be automatically cancelled if the flight has not been started.

11.4.2.6.2.2 Instructions included in clearances relating to levels shall consist of:

- a) cruising level(s) or, for cruise climb, a range of levels, and, if necessary, the point to which the clearance is valid with regard to the level(s);

Note.— See 11.4.2.6.2.1 d) and associated Note.

- b) levels at which specified significant points are to be crossed, when necessary;
- c) the place or time for starting climb or descent, when necessary;
- d) the rate of climb or descent, when necessary;
- e) detailed instructions concerning departure or approach levels, when necessary.

11.4.2.6.2.3 It is the responsibility of the aeronautical station or aircraft operator who has received the clearance to transmit it to the aircraft at the specified or expected delivery time, and to notify the air traffic control unit promptly if it is not delivered within a specified period of time.

11.4.2.6.2.4 Personnel receiving clearances for transmission to aircraft shall transmit such clearances in the exact phraseology in which they are received. In those cases where the personnel transmitting the clearances to the aircraft do not form part of the air traffic services, it is essential that appropriate arrangements be made to meet this requirement.

11.4.2.6.2.5 Level restrictions issued by ATC in air-ground communications shall be repeated in conjunction with subsequent level clearances in order to remain in effect.

Note.— See also Chapter 6, 6.3.2.4 and 6.5.2.4, regarding level restrictions published as elements of SIDs and STARs.

11.4.2.6.3 FLOW CONTROL MESSAGES

Note 1.— Provisions governing the control of air traffic flow are set forth in Annex 11, 3.7.5 and in Chapter 3, 3.2.5.2 of this document. Attention is drawn, however, to the guidance material contained in the Air Traffic Services Planning Manual (Doc 9426) regarding flow control.

Note 2.— Format and data conventions for automated interchange of flow control messages have not yet been developed.

11.4.2.6.4 POSITION-REPORT AND AIR-REPORT MESSAGES

Note.— Provisions governing position reporting are set forth in Annex 2, 3.6.3 and 5.3.3, and in Chapter 4, Sections 4.11 and 4.12 of this document.

11.4.2.6.4.1 The format and data conventions to be used in position-report and special air-report messages are those specified on the model AIREP SPECIAL form at Appendix 1, using:

- a) for position-report messages: Section 1;
- b) for special air-report messages: Section 1 followed by Sections 2 and/or 3 as relevant.

11.4.2.6.4.2 Where special air-report messages transmitted by voice communications are subsequently forwarded by automatic data-processing equipment which cannot accept the special air-report message type designator ARS, the use of a different message-type designator shall be permitted by regional air navigation agreement and should be reflected in the *Regional Supplementary Procedures* (Doc 7030) provided that:

- a) the data transmitted accord with that specified in the special air-report format; and
- b) measures are taken to ensure that special air-report messages are forwarded to the appropriate meteorological unit and to other aircraft likely to be affected.

11.4.3 Flight information messages

11.4.3.1 MESSAGES CONTAINING TRAFFIC INFORMATION

Note.— Provisions governing the issuance of traffic information are set forth in Annex 11, 4.2.2 b) and Notes 1 and 2 and in Chapter 5, Section 5.10, and Chapter 7, Section 7.4.1 of this document.

11.4.3.1.1 MESSAGES CONTAINING TRAFFIC INFORMATION TO AIRCRAFT OPERATING OUTSIDE CONTROLLED AIRSPACE

11.4.3.1.1.1 Due to the factors influencing the nature of the flight information services, and particularly the question of provision of information on possible collision hazards to aircraft operating outside controlled airspace, it is not possible to specify standard texts for these messages.

11.4.3.1.1.2 Where such messages are transmitted they shall, however, contain sufficient data on the direction of flight and the estimated time, level and point at which the aircraft involved in the possible collision hazard will pass, overtake or approach each other. This information shall be given in such a way that the pilot of each aircraft concerned is able to appreciate clearly the nature of the hazard.

11.4.3.1.2 MESSAGES CONTAINING ESSENTIAL TRAFFIC INFORMATION TO IFR FLIGHTS OUTSIDE CONTROLLED AIRSPACE

Whenever such messages are transmitted they shall contain the following text:

- a) identification of the aircraft to which the information is transmitted;
- b) the words TRAFFIC IS or ADDITIONAL TRAFFIC IS;
- c) direction of flight of aircraft concerned;
- d) type of aircraft concerned;
- e) cruising level of aircraft concerned and ETA for the significant point nearest to where the aircraft will cross levels.

11.4.3.1.3 MESSAGES CONTAINING ESSENTIAL LOCAL TRAFFIC INFORMATION

Whenever such messages are transmitted they shall contain the following text:

- a) identification of the aircraft to which the information is transmitted;
- b) the words TRAFFIC IS or ADDITIONAL TRAFFIC IS, if necessary;
- c) description of the essential local traffic in terms that will facilitate recognition of it by the pilot, e.g. type, speed category and/or colour of aircraft, type of vehicle, number of persons;
- d) position of the essential local traffic relative to the aircraft concerned, and direction of movement.

11.4.3.2 MESSAGES CONTAINING METEOROLOGICAL INFORMATION

Note.— Provisions governing the making and reporting of aircraft observations are contained in Annex 3. Provisions concerning the contents and transmission of air-reports are contained in Chapter 4, Section 4.12 of this document, and the special air-report of volcanic activity form used for reports of volcanic activity is shown in Appendix 1 to this document. The transmission by ATS units, to meteorological offices, of meteorological information received from aircraft in flight is governed by provisions in Chapter 4, Section 4.12.6 of this document. Provisions governing the transmission by ATS units of meteorological information to aircraft are set forth in Annex 11, 4.2 and in this document (see Chapter 4, 4.8.3 and 4.10.4; Chapter 6, Sections 6.4 and 6.6; Chapter 7, 7.4.1; and Chapter 9, 9.1.3). The written forms of SIGMET and AIRMET messages and other plain-language meteorological messages are governed by the provisions of Annex 3.

11.4.3.2.1 Information to a pilot changing from IFR flight to VFR flight where it is likely that flight in VMC cannot be maintained shall be given in the following manner:

“INSTRUMENT METEOROLOGICAL CONDITIONS REPORTED (or forecast) IN THE VICINITY OF (location)”.

11.4.3.2.2 Meteorological information concerning the meteorological conditions at aerodromes, to be transmitted to aircraft by the ATS unit concerned, in accordance with Annex 11, Chapter 4 and this document, Chapter 6, Sections 6.4 and 6.6 and Chapter 7, Section 7.4.1, shall be extracted by the ATS unit concerned from the following meteorological messages, provided by the appropriate meteorological office, supplemented for arriving and departing aircraft, as appropriate, by information from displays relating to meteorological sensors (in particular, those related to the surface wind and runway visual range) located in the ATS units:

- a) local meteorological routine and special reports;
- b) METAR/SPECI, for dissemination to other aerodromes beyond the aerodrome of origin (mainly intended for flight planning, VOLMET broadcasts and D-VOLMET).

11.4.3.2.3 The meteorological information referred to in 11.4.3.2.2 shall be extracted, as appropriate, from meteorological reports providing information on the following elements:

- a) mean surface wind direction and speed and significant variations therefrom;

Note.— Information on surface wind direction provided to ATS units by the associated meteorological office is referenced to degrees true North. Information on surface wind direction obtained from the ATS surface wind indicator and passed to pilots by ATS units is given in degrees magnetic.

- b) visibility, including significant directional variations;
- c) runway visual range (RVR);
- d) present weather;
- e) amount and height of base of low cloud;
- f) air temperature and dew-point temperature;
- g) altimeter setting(s); and
- h) supplementary information.

Note. — Provisions relating to meteorological information to be provided in accordance with 11.4.3.2.3 are contained in Annex 3 — Meteorological Service for International Air Navigation, Chapter 4 and Appendix 3.

11.4.3.3 MESSAGES CONCERNING THE OPERATION OF AERONAUTICAL FACILITIES

Note.— *General provisions concerning this subject are set forth in Annex 11, 4.2.*

Messages concerning the operation of aeronautical facilities shall be transmitted to aircraft from whose flight plan it is apparent that the operation of the flight may be affected by the operating status of the operating facility concerned. They shall contain appropriate data on the service status of the facility in question, and, if the facility is out of operation, an indication when the normal operating status will be restored.

11.4.3.4 MESSAGES CONTAINING INFORMATION ON AERODROME CONDITIONS

Note.— *Provisions regarding the issuance of information on aerodrome conditions are contained in Chapter 7, 7.5.*

11.4.3.4.1 Whenever information is provided on aerodrome conditions, this shall be done in a clear and concise manner so as to facilitate appreciation by the pilot of the situation described. It shall be issued whenever deemed necessary by the controller on duty in the interest of safety, or when requested by an aircraft. If the information is provided on the initiative of the controller, it shall be transmitted to each aircraft concerned in sufficient time to enable the pilot to make proper use of the information.

11.4.3.4.2 Information that water is present on a runway shall be transmitted to each aircraft concerned, on the initiative of the controller, using the following terms:

DAMP — the surface shows a change of colour due to moisture.

WET — the surface is soaked but there is no standing water.

STANDING WATER — for aeroplane performance purposes, a runway where more than 25 per cent of the runway surface area (whether in isolated areas or not) within the required length and width being used is covered by water more than 3 mm deep.

11.4.3.5 MESSAGES CONCERNING AIR TRAFFIC INCIDENT REPORTS

When an aircraft involved in an incident has a destination outside the area of responsibility of the ATS unit where the incident occurred, the ATS unit at the destination aerodrome should be notified and requested to obtain the pilot's report. The following information should be included in the message:

- a) type of incident (AIRPROX, procedure or facility);
- b) identification of the aircraft concerned;
- c) time and position at time of incident;
- d) brief details of incident.

Chapter 12

PHRASEOLOGIES

12.1 COMMUNICATIONS PROCEDURES

The communications procedures shall be in accordance with Volume II of Annex 10 — *Aeronautical Telecommunications*, and pilots, ATS personnel and other ground personnel shall be thoroughly familiar with the radiotelephony procedures contained therein.

12.2 GENERAL

Note.— *Requirements for readback of clearances and safety-related information are provided in Chapter 4, 4.5.7.5.*

12.2.1 Most phraseologies contained in Section 12.3 of this Chapter show the text of a complete message without call signs. They are not intended to be exhaustive, and when circumstances differ, pilots, ATS personnel and other ground personnel will be expected to use plain language, which should be as clear and concise as possible, to the level specified in the ICAO language proficiency requirements contained in Annex 1 — *Personnel Licensing*, in order to avoid possible confusion by those persons using a language other than one of their national languages.

12.2.2 The phraseologies are grouped according to types of air traffic service for convenience of reference. However, users shall be familiar with, and use as necessary, phraseologies from groups other than those referring specifically to the type of air traffic service being provided. All phraseologies shall be used in conjunction with call signs (aircraft, ground vehicle, ATC or other) as appropriate. In order that the phraseologies listed should be readily discernible in Section 12.3, call signs have been omitted. Provisions for the compilation of RTF messages, call signs and procedures are contained in Annex 10, Volume II, Chapter 5.

12.2.3 Section 12.3 includes phrases for use by pilots, ATS personnel and other ground personnel.

12.2.4 During operations in or vertical transit through reduced vertical separation minimum (RVSM) airspace with aircraft not approved for RVSM operations, pilots shall report non-approved status in accordance with 12.3.1.12 c) as follows:

- a) at initial call on any channel within RVSM airspace;
- b) in all requests for level changes; and
- c) in all readbacks of level clearances.

12.2.5 Air traffic controllers shall explicitly acknowledge receipt of messages from aircraft reporting RVSM non-approved status.

12.2.6 Phraseologies for the movement of vehicles, other than tow-tractors, on the manoeuvring area shall be the same as those used for the movement of aircraft, with the exception of taxi instructions, in which case the word “PROCEED” shall be substituted for the word “TAXI” when communicating with vehicles.

12.2.7 Conditional phrases, such as “behind landing aircraft” or “after departing aircraft”, shall not be used for movements affecting the active runway(s), except when the aircraft or vehicles concerned are seen by the appropriate controller and pilot. The aircraft or vehicle causing the condition in the clearance issued shall be the first aircraft/vehicle to pass in front of the other aircraft concerned. In all cases a conditional clearance shall be given in the following order and consist of:

- a) identification;
- b) the condition;
- c) the clearance; and
- d) brief reiteration of the condition,

for example:

“SAS 941, BEHIND DC9 ON SHORT FINAL, LINE UP BEHIND”.

Note.— This implies the need for the aircraft receiving the conditional clearance to identify the aircraft or vehicle causing the conditional clearance.

12.2.8 The phraseology in Section 12.3 does not include phrases and regular radiotelephony procedure words contained in Annex 10, Volume II.

12.2.9 Words in parentheses indicate that specific information, such as a level, a place or a time, etc., must be inserted to complete the phrase, or alternatively that optional phrases may be used. Words in square parentheses indicate optional additional words or information that may be necessary in specific instances.

12.2.10 Examples of the application of the phraseologies may be found in the *Manual of Radiotelephony* (Doc 9432).

12.3 ATC PHRASEOLOGIES

12.3.1 General

<i>Circumstances</i>	<i>Phraseologies</i>
12.3.1.1 DESCRIPTION OF LEVELS (SUBSEQUENTLY REFERRED TO AS “(LEVEL)”)	<ol style="list-style-type: none"> a) FLIGHT LEVEL (<i>number</i>); <i>or</i> b) (<i>number</i>) METRES; <i>or</i> c) (<i>number</i>) FEET.
12.3.1.2 LEVEL CHANGES, REPORTS AND RATES	<ol style="list-style-type: none"> a) CLIMB (<i>or</i> DESCEND); <i>followed as necessary by:</i> <ol style="list-style-type: none"> 1) TO (<i>level</i>);

<i>Circumstances</i>	<i>Phraseologies</i>
... instruction that a climb (or descent) to a level within the vertical range defined is to commence	2) TO AND MAINTAIN BLOCK (<i>level</i>) TO (<i>level</i>); 3) TO REACH (<i>level</i>) AT (<i>or BY</i>) (<i>time or significant point</i>); 4) REPORT LEAVING (<i>or REACHING, or PASSING</i>) (<i>level</i>); 5) AT (<i>number</i>) METRES PER SECOND (<i>or FEET PER MINUTE</i>) [OR GREATER (<i>or OR LESS</i>)];
... for SST aircraft only	6) REPORT STARTING ACCELERATION (<i>or DECELERATION</i>). b) MAINTAIN AT LEAST (<i>number</i>) METRES (<i>or FEET</i>) ABOVE (<i>or BELOW</i>) (<i>aircraft call sign</i>); c) REQUEST LEVEL (<i>or FLIGHT LEVEL or ALTITUDE</i>) CHANGE FROM (<i>name of unit</i>) [AT (<i>time or significant point</i>)]; d) STOP CLIMB (<i>or DESCENT</i>) AT (<i>level</i>); e) CONTINUE CLIMB (<i>or DESCENT</i>) TO (<i>level</i>); f) EXPEDITE CLIMB (<i>or DESCENT</i>) [UNTIL PASSING (<i>level</i>)]; g) WHEN READY CLIMB (<i>or DESCEND</i>) TO (<i>level</i>); h) EXPECT CLIMB (<i>or DESCENT</i>) AT (<i>time or significant point</i>); *i) REQUEST DESCENT AT (<i>time</i>);
... to require action at a specific time or place	j) IMMEDIATELY; k) AFTER PASSING (<i>significant point</i>); l) AT (<i>time or significant point</i>);
... to require action when convenient	m) WHEN READY (<i>instruction</i>);

<i>Circumstances</i>	<i>Phraseologies</i>
... to require an aircraft to climb or descend maintaining own separation and VMC	n) MAINTAIN OWN SEPARATION AND VMC [FROM <i>(level)</i>] [TO <i>(level)</i>];
	o) MAINTAIN OWN SEPARATION AND VMC ABOVE (<i>or</i> BELOW, <i>or</i> TO) <i>(level)</i> ;
... when there is doubt that an aircraft can comply with a clearance or instruction	p) IF UNABLE (<i>alternative instructions</i>) AND ADVISE;
... when a pilot is unable to comply with a clearance or instruction	*q) UNABLE;
... after a flight crew starts to deviate from any ATC clearance or instruction to comply with an ACAS resolution advisory (RA) (Pilot and controller interchange)	*r) TCAS RA; s) ROGER;
... after the response to an ACAS RA is completed and a return to the ATC clearance or instruction is initiated (Pilot and controller interchange)	*t) CLEAR OF CONFLICT, RETURNING TO (<i>assigned clearance</i>); u) ROGER (<i>or alternative instructions</i>);
... after the response to an ACAS RA is completed and the assigned ATC clearance or instruction has been resumed (Pilot and controller interchange)	*v) CLEAR OF CONFLICT (<i>assigned clearance</i>) RESUMED; w) ROGER (<i>or alternative instructions</i>);
... after an ATC clearance or instruction contradictory to the ACAS RA is received, the flight crew will follow the RA and inform ATC directly (Pilot and controller interchange)	*x) UNABLE, TCAS RA; y) ROGER;

<i>Circumstances</i>	<i>Phraseologies</i>
... clearance to climb on a SID which has published level and/or speed restrictions, where the pilot is to climb to the cleared level and comply with published level restrictions, follow the lateral profile of the SID and comply with published speed restrictions or ATC issued speed control instructions as applicable.	z) CLIMB VIA SID TO <i>(level)</i> .
... clearance to cancel level restriction(s) of the vertical profile of a SID during climb	aa) [CLIMB VIA SID TO <i>(level)</i>], CANCEL LEVEL RESTRICTION(S);
... clearance to cancel specific level restriction(s) of the vertical profile of a SID during climb	bb) [CLIMB VIA SID TO <i>(level)</i>], CANCEL LEVEL RESTRICTION(S) AT <i>(point(s))</i> ;
... clearance to cancel speed restrictions of a SID during climb	cc) [CLIMB VIA SID TO <i>(level)</i>], CANCEL SPEED RESTRICTION(S);
... clearance to cancel specific speed restrictions of a SID during climb	dd) [CLIMB VIA SID TO <i>(level)</i>], CANCEL SPEED RESTRICTION(S) AT <i>(point(s))</i> ;
...clearance to climb and to cancel speed and level restrictions of a SID	ee) CLIMB UNRESTRICTED TO <i>(level)</i> (or) CLIMB TO <i>(level)</i> , CANCEL LEVEL AND SPEED RESTRICTIONS;
... clearance to descend on a STAR which has published level and/or speed restrictions, where the pilot is to descend to the cleared level and comply with published level restrictions, follow the lateral profile of the STAR and comply with published speed restrictions or ATC issued speed control instructions.	ff) DESCEND VIA STAR TO <i>(level)</i> ;

<i>Circumstances</i>	<i>Phraseologies</i>
... clearance to cancel level restrictions of a STAR during descent	gg) [DESCEND VIA STAR TO <i>(level)</i>], CANCEL LEVEL RESTRICTION(S);
... clearance to cancel specific level restrictions of a STAR during descent	hh) [DESCEND VIA STAR TO <i>(level)</i>], CANCEL LEVEL RESTRICTION(S) AT <i>(point(s))</i> ;
... clearance to cancel speed restrictions of a STAR during descent	ii) [DESCEND VIA STAR TO <i>(level)</i>], CANCEL SPEED RESTRICTION(S);
... clearance to cancel specific speed restrictions of a STAR during descent	jj) [DESCEND VIA STAR TO <i>(level)</i>], CANCEL SPEED RESTRICTION(S) AT <i>(point(s))</i> ;
... clearance to descend and to cancel speed and level restrictions of a STAR	kk) DESCEND UNRESTRICTED TO <i>(level)</i> or DESCEND TO <i>(level)</i> , CANCEL LEVEL AND SPEED RESTRICTIONS.
	* Denotes pilot transmission.
12.3.1.3 MINIMUM FUEL	
... indication of minimum fuel	*a) MINIMUM FUEL; b) ROGER [NO DELAY EXPECTED or EXPECT <i>(delay information)</i>].
	* Denotes pilot transmission.
12.3.1.4 TRANSFER OF CONTROL AND/OR FREQUENCY CHANGE	
	a) CONTACT <i>(unit call sign) (frequency)</i> [NOW];
	b) AT <i>(or OVER) (time or place)</i> [or WHEN] [PASSING/LEAVING/REACHING <i>(level)</i>] CONTACT <i>(unit call sign) (frequency)</i> ;
	c) IF NO CONTACT <i>(instructions)</i> ;
<i>Note.— An aircraft may be</i>	d) STAND BY FOR <i>(unit call sign) (frequency)</i> ;

Circumstances	Phraseologies
<p>requested to “STAND BY” on a frequency when it is intended that the ATS unit will initiate communications soon and to “MONITOR” a frequency when information is being broadcast thereon.</p>	<p>*e) REQUEST CHANGE TO (frequency); f) FREQUENCY CHANGE APPROVED; g) MONITOR (unit call sign) (frequency); *h) MONITORING (frequency); i) WHEN READY CONTACT (unit call sign) (frequency); j) REMAIN THIS FREQUENCY. * Denotes pilot transmission.</p>
<p>12.3.1.5 8.33 kHz CHANNEL SPACING</p>	
<p><i>Note.— In this paragraph, the term “point” is used only in the context of naming the 8.33 kHz channel spacing concept and does not constitute any change to existing ICAO provisions or phraseology regarding the use of the term “decimal”.</i></p>	
<p>... to request confirmation of 8.33 kHz capability</p>	<p>a) CONFIRM EIGHT POINT THREE THREE;</p>
<p>... to indicate 8.33 kHz capability</p>	<p>*b) AFFIRM EIGHT POINT THREE THREE;</p>
<p>... to indicate lack of 8.33 kHz capability</p>	<p>*c) NEGATIVE EIGHT POINT THREE THREE;</p>
<p>... to request UHF capability</p>	<p>d) CONFIRM UHF;</p>
<p>... to indicate UHF capability</p>	<p>*e) AFFIRM UHF;</p>
<p>... to indicate lack of UHF capability</p>	<p>*f) NEGATIVE UHF;</p>
<p>... to request status in respect of 8.33 kHz exemption</p>	<p>g) CONFIRM EIGHT POINT THREE THREE EXEMPTED;</p>
<p>... to indicate 8.33 kHz exempted status</p>	<p>*h) AFFIRM EIGHT POINT THREE THREE EXEMPTED;</p>
<p>... to indicate 8.33 kHz non-exempted status</p>	<p>*i) NEGATIVE EIGHT POINT THREE THREE EXEMPTED;</p>

<i>Circumstances</i>	<i>Phraseologies</i>
<p>... to indicate that a certain clearance is given because otherwise a non-equipped and/or non-exempted aircraft would enter airspace of mandatory carriage</p>	<p>j) DUE EIGHT POINT THREE THREE REQUIREMENT.</p> <p>* Denotes pilot transmission.</p>
<p>12.3.1.6 CHANGE OF CALL SIGN</p> <p>... to instruct an aircraft to change its type of call sign</p> <p>... to advise an aircraft to revert to the call sign indicated in the flight plan</p>	<p>a) CHANGE YOUR CALL SIGN TO (<i>new call sign</i>) [UNTIL FURTHER ADVISED];</p> <p>b) REVERT TO FLIGHT PLAN CALL SIGN (<i>call sign</i>) [AT (<i>significant point</i>)].</p>
<p>12.3.1.7 TRAFFIC INFORMATION</p> <p>... to pass traffic information</p> <p>... to acknowledge traffic information</p>	<p>a) TRAFFIC (<i>information</i>);</p> <p>b) NO REPORTED TRAFFIC;</p> <p>*c) LOOKING OUT;</p> <p>*d) TRAFFIC IN SIGHT;</p> <p>*e) NEGATIVE CONTACT [<i>reasons</i>];</p> <p>f) [ADDITIONAL] TRAFFIC (<i>direction</i>) BOUND (<i>type of aircraft</i>) (<i>level</i>) ESTIMATED (<i>or OVER</i>) (<i>significant point</i>) AT (<i>time</i>);</p> <p>g) TRAFFIC IS (<i>classification</i>) UNMANNED FREE BALLOON(S) WAS [<i>or ESTIMATED</i>] OVER (<i>place</i>) AT (<i>time</i>) REPORTED (<i>level(s)</i>) [<i>or LEVEL UNKNOWN</i>] MOVING (<i>direction</i>) (<i>other pertinent information, if any</i>).</p> <p>* Denotes pilot transmission.</p>
<p>12.3.1.8 METEOROLOGICAL CONDITIONS</p>	<p>a) [SURFACE] WIND (<i>number</i>) DEGREES (<i>speed</i>) (<i>units</i>);</p> <p>b) WIND AT (<i>level</i>) (<i>number</i>) DEGREES (<i>number</i>) KILOMETRES PER HOUR (<i>or KNOTS</i>);</p> <p style="text-align: center;"><i>Note.— Wind is always expressed by giving the mean direction and speed and any significant variations thereof.</i></p> <p>c) VISIBILITY (<i>distance</i>) (<i>units</i>) [<i>direction</i>];</p> <p>d) RUNWAY VISUAL RANGE (<i>or RVR</i>) [RUNWAY (<i>number</i>)] (<i>distance</i>) (<i>units</i>);</p>

<i>Circumstances</i>	<i>Phraseologies</i>
... for multiple RVR observations	<p>e) RUNWAY VISUAL RANGE (or RVR) RUNWAY (number) NOT AVAILABLE (or NOT REPORTED);</p> <p>f) RUNWAY VISUAL RANGE (or RVR) [RUNWAY (number)] (first position) (distance) (units), (second position) (distance) (units), (third position) (distance) (units);</p> <p style="text-align: center;"><i>Note 1.— Multiple RVR observations are always representative of the touchdown zone, midpoint zone and the roll-out/stop end zone, respectively.</i></p> <p style="text-align: center;"><i>Note 2.— Where reports for three locations are given, the indication of these locations may be omitted, provided that the reports are passed in the order of touchdown zone, followed by the midpoint zone and ending with the roll-out/stop end zone report.</i></p>
... in the event that RVR information on any one position is not available this information will be included in the appropriate sequence	<p>g) RUNWAY VISUAL RANGE (or RVR) [RUNWAY (number)] (first position) (distance) (units), (second position) NOT AVAILABLE, (third position) (distance) (units);</p> <p>h) PRESENT WEATHER (details);</p> <p>i) CLOUD (amount, [(type)] and height of base) (units) (or SKY CLEAR);</p> <p style="text-align: center;"><i>Note.— Details of the means to describe the amount and type of cloud are in Chapter 11, 11.4.3.2.3.</i></p> <p>j) CAVOK;</p> <p style="text-align: center;"><i>Note.— CAVOK pronounced CAV-O-KAY.</i></p> <p>k) TEMPERATURE [MINUS] (number) (and/or DEWPOINT [MINUS] (number));</p> <p>l) QNH (number) [(units)];</p> <p>m) QFE (number) [(units)];</p> <p>n) (aircraft type) REPORTED (description) ICING (or TURBULENCE) [IN CLOUD] (area) (time);</p> <p>o) REPORT FLIGHT CONDITIONS.</p>
12.3.1.9 POSITION REPORTING	<p>a) NEXT REPORT AT (significant point);</p>

<i>Circumstances</i>	<i>Phraseologies</i>
... to omit position reports until a specified position	b) OMIT POSITION REPORTS [UNTIL (<i>specify</i>)]; c) RESUME POSITION REPORTING.
12.3.1.10 ADDITIONAL REPORTS	a) REPORT PASSING (<i>significant point</i>);
... to request a report at a specified place or distance	b) REPORT (<i>distance</i>) MILES (GNSS or DME) FROM (<i>name of DME station</i>) (or <i>significant point</i>);
... to report at a specified place or distance	*c) (<i>distance</i>) MILES (GNSS or DME) FROM (<i>name of DME station</i>) (or <i>significant point</i>);
... to request a report of present position	d) REPORT PASSING (<i>three digits</i>) RADIAL (<i>name of VOR</i>) VOR;
... to report present position	e) REPORT (GNSS or DME) DISTANCE FROM (<i>significant point</i>) or (<i>name of DME station</i>);
	*f) (<i>distance</i>) MILES (GNSS or DME) FROM (<i>name of DME station</i>) (or <i>significant point</i>).
	* Denotes pilot transmission.
12.3.1.11 AERODROME INFORMATION	a) [(<i>location</i>)] RUNWAY SURFACE CONDITION RUNWAY (<i>number</i>) (<i>condition</i>);
	b) [(<i>location</i>)] RUNWAY SURFACE CONDITION RUNWAY (<i>number</i>) NOT CURRENT;
	c) LANDING SURFACE (<i>condition</i>);
	d) CAUTION CONSTRUCTION WORK (<i>location</i>);
	e) CAUTION (<i>specify reasons</i>) RIGHT (or LEFT), (or BOTH SIDES) OF RUNWAY [<i>number</i>];
	f) CAUTION WORK IN PROGRESS (or OBSTRUCTION) (<i>position and any necessary advice</i>);
	g) RUNWAY REPORT AT (<i>observation time</i>) RUNWAY (<i>number</i>) (<i>type of precipitant</i>) UP TO (<i>depth of deposit</i>) MILLIMETRES. ESTIMATED SURFACE FRICTION GOOD (or MEDIUM TO GOOD, or MEDIUM, or MEDIUM TO POOR, or POOR);
	h) BRAKING ACTION REPORTED BY (<i>aircraft type</i>) AT (<i>time</i>) GOOD (or MEDIUM to GOOD, or MEDIUM, or MEDIUM to POOR, or POOR);

<i>Circumstances</i>	<i>Phraseologies</i>
12.3.1.12 OPERATIONAL STATUS OF VISUAL AND NON-VISUAL AIDS	<ul style="list-style-type: none"> <li data-bbox="695 289 1430 510">i) RUNWAY (or TAXIWAY) (number) WET [or STANDING WATER, or SNOW REMOVED (length and width as applicable), or TREATED, or COVERED WITH PATCHES OF DRY SNOW (or WET SNOW, or COMPACTED SNOW, or SLUSH, or FROZEN SLUSH, or ICE, or WET ICE, or ICE UNDERNEATH, or ICE AND SNOW, or SNOWDRIFTS, or FROZEN RUTS AND RIDGES)]; <li data-bbox="695 541 1235 575">j) TOWER OBSERVES (weather information); <li data-bbox="695 606 1195 640">k) PILOT REPORTS (weather information). <hr/> <ul style="list-style-type: none"> <li data-bbox="695 672 1333 735">a) (specify visual or non-visual aid) RUNWAY (number) (description of deficiency); <li data-bbox="695 766 1146 800">b) (type) LIGHTING (unservicability); <li data-bbox="695 831 1430 894">c) GBAS/SBAS/MLS/ILS CATEGORY (category) (servicability state); <li data-bbox="695 926 1300 959">d) TAXIWAY LIGHTING (description of deficiency); <li data-bbox="695 991 1414 1054">e) (type of visual approach slope indicator) RUNWAY (number) (description of deficiency).

<i>Circumstances</i>	<i>Phraseologies</i>
12.3.1.13 REDUCED VERTICAL SEPARATION MINIMUM (RVSM) OPERATIONS	
... to ascertain RVSM approval status of an aircraft	a) CONFIRM RVSM APPROVED;
... to report RVSM approved status	*b) AFFIRM RVSM;
... to report RVSM non-approved status followed by supplementary information	*c) NEGATIVE RVSM [(supplementary information, e.g. State aircraft)];
<i>Note.— See 12.2.4 and 12.2.5 for procedures relating to operations in RVSM airspace by aircraft with non-approved status.</i>	
... to deny ATC clearance into RVSM airspace	d) UNABLE ISSUE CLEARANCE INTO RVSM AIRSPACE, MAINTAIN [or DESCEND TO, or CLIMB TO] (level);
... to report when severe turbulence affects the capability of an aircraft to maintain height-keeping requirements for RVSM	*e) UNABLE RVSM DUE TURBULENCE;
... to report that the equipment of an aircraft has degraded below minimum aviation system performance standards	*f) UNABLE RVSM DUE EQUIPMENT;
...to request an aircraft to provide information as soon as RVSM-approved status has been regained or the pilot is ready to resume RVSM operations	g) REPORT WHEN ABLE TO RESUME RVSM;
... to request confirmation that an aircraft has regained RVSM-approved status or a pilot is ready to resume RVSM operations	h) CONFIRM ABLE TO RESUME RVSM;
... to report ability to resume RVSM operations after an equipment or weather-related contingency	*i) READY TO RESUME RVSM.
	* Denotes pilot transmission.

<i>Circumstances</i>	<i>Phraseologies</i>
12.3.1.14 GNSS SERVICE STATUS	<p>a) GNSS REPORTED UNRELIABLE (or GNSS MAY NOT BE AVAILABLE [DUE TO INTERFERENCE]);</p> <p>1) IN THE VICINITY OF (<i>location</i>) (<i>radius</i>) [BETWEEN (<i>levels</i>)]; or</p> <p>2) IN THE AREA OF (<i>description</i>) (or IN (<i>name</i>) FIR) [BETWEEN (<i>levels</i>)];</p> <p>b) BASIC GNSS (or SBAS, or GBAS) UNAVAILABLE FOR (<i>specify operation</i>) [FROM (<i>time</i>) TO (<i>time</i>) (or UNTIL FURTHER NOTICE)];</p> <p>*c) BASIC GNSS UNAVAILABLE [DUE TO (<i>reason, e.g. LOSS OF RAIM or RAIM ALERT</i>)];</p> <p>*d) GBAS (or SBAS) UNAVAILABLE;</p> <p>e) CONFIRM GNSS NAVIGATION; and</p> <p>*f) AFFIRM GNSS NAVIGATION.</p> <p>* Denotes pilot transmission.</p>
12.3.1.15 DEGRADATION OF AIRCRAFT NAVIGATION PERFORMANCE	UNABLE RNP (<i>specify type</i>) (or RNAV) [DUE TO (<i>reason, e.g. LOSS OF RAIM or RAIM ALERT</i>)].

12.3.2 Area control services

<i>Circumstances</i>	<i>Phraseologies</i>
12.3.2.1 ISSUANCE OF A CLEARANCE	<p>a) (<i>name of unit</i>) CLEARS (<i>aircraft call sign</i>);</p> <p>b) (<i>aircraft call sign</i>) CLEARED TO;</p> <p>c) RECLEARED (<i>amended clearance details</i>) [REST OF CLEARANCE UNCHANGED];</p> <p>d) RECLEARED (<i>amended route portion</i>) TO (<i>significant point of original route</i>) [REST OF CLEARANCE UNCHANGED];</p> <p>e) ENTER CONTROLLED AIRSPACE (or CONTROL ZONE) [VIA (<i>significant point or route</i>)] AT (<i>level</i>) [AT (<i>time</i>)];</p> <p>f) LEAVE CONTROLLED AIRSPACE (or CONTROL ZONE) [VIA (<i>significant point or route</i>)] AT (<i>level</i>) (or CLIMBING, or DESCENDING);</p> <p>g) JOIN (<i>specify</i>) AT (<i>significant point</i>) AT (<i>level</i>) [AT (<i>time</i>)].</p>

<i>Circumstances</i>	<i>Phraseologies</i>
12.3.2.2 INDICATION OF ROUTE AND CLEARANCE LIMIT	<p>a) FROM <i>(location)</i> TO <i>(location)</i>;</p> <p>b) TO <i>(location)</i>,</p> <p style="padding-left: 40px;"><i>followed as necessary by:</i></p> <p style="padding-left: 80px;">1) DIRECT;</p> <p style="padding-left: 80px;">2) VIA <i>(route and/or significant points)</i>;</p> <p style="padding-left: 80px;">3) FLIGHT PLANNED ROUTE;</p> <p style="padding-left: 40px;"><i>Note.— Conditions associated with the use of this phrase are in Chapter 4, 4.5.7.2.</i></p> <p style="padding-left: 80px;">4) VIA <i>(distance)</i> DME ARC <i>(direction)</i> OF <i>(name of DME station)</i>;</p> <p>c) <i>(route)</i> NOT AVAILABLE DUE <i>(reason)</i> ALTERNATIVE[S] IS/ARE <i>(routes)</i> ADVISE.</p>
12.3.2.3 MAINTENANCE OF SPECIFIED LEVELS	<p>a) MAINTAIN <i>(level)</i> [TO <i>(significant point)</i>];</p> <p>b) MAINTAIN <i>(level)</i> UNTIL PASSING <i>(significant point)</i>;</p> <p>c) MAINTAIN <i>(level)</i> UNTIL <i>(minutes)</i> AFTER PASSING <i>(significant point)</i>;</p> <p>d) MAINTAIN <i>(level)</i> UNTIL <i>(time)</i>;</p> <p>e) MAINTAIN <i>(level)</i> UNTIL ADVISED BY <i>(name of unit)</i>;</p> <p>f) MAINTAIN <i>(level)</i> UNTIL FURTHER ADVISED;</p> <p>g) MAINTAIN <i>(level)</i> WHILE IN CONTROLLED AIRSPACE;</p> <p>h) MAINTAIN BLOCK <i>(level)</i> TO <i>(level)</i>.</p> <p style="padding-left: 40px;"><i>Note.— The term “MAINTAIN” is not to be used in lieu of “DESCEND” or “CLIMB” when instructing an aircraft to change level.</i></p>
12.3.2.4 SPECIFICATION OF CRUISING LEVELS	<p>a) CROSS <i>(significant point)</i> AT <i>(or ABOVE, or BELOW)</i> <i>(level)</i>;</p> <p>b) CROSS <i>(significant point)</i> AT <i>(time)</i> OR LATER <i>(or BEFORE)</i> AT <i>(level)</i>;</p> <p>c) CRUISE CLIMB BETWEEN <i>(levels)</i> <i>(or ABOVE (level))</i>;</p> <p>d) CROSS <i>(distance)</i> MILES, (GNSS or DME) [<i>(direction)</i>] OF <i>(name of DME station)</i> OR <i>(distance)</i> [<i>(direction)</i>] OF <i>(significant point)</i> AT <i>(or ABOVE or BELOW)</i> <i>(level)</i>.</p>

<i>Circumstances</i>	<i>Phraseologies</i>
12.3.2.5 EMERGENCY DESCENT	<p>*a) EMERGENCY DESCENT (<i>intentions</i>);</p> <p>b) ATTENTION ALL AIRCRAFT IN THE VICINITY OF [<i>or AT</i>] (<i>significant point or location</i>) EMERGENCY DESCENT IN PROGRESS FROM (<i>level</i>) (followed as necessary by specific instructions, clearances, traffic information, etc.).</p> <p>* Denotes pilot transmission.</p>
12.3.2.6 IF CLEARANCE CANNOT BE ISSUED IMMEDIATELY UPON REQUEST	EXPECT CLEARANCE (<i>or type of clearance</i>) AT (<i>time</i>).
12.3.2.7 WHEN CLEARANCE FOR DEVIATION CANNOT BE ISSUED	UNABLE, TRAFFIC (<i>direction</i>) BOUND (<i>type of aircraft</i>) (<i>level</i>) ESTIMATED (<i>or OVER</i>) (<i>significant point</i>) AT (<i>time</i>) CALL SIGN (<i>call sign</i>) ADVISE INTENTIONS.
12.3.2.8 SEPARATION INSTRUCTIONS	<p>a) CROSS (<i>significant point</i>) AT (<i>time</i>) [OR LATER (<i>or OR BEFORE</i>)];</p> <p>b) ADVISE IF ABLE TO CROSS (<i>significant point</i>) AT (<i>time or level</i>);</p> <p>c) MAINTAIN MACH (<i>number</i>) [OR GREATER (<i>or OR LESS</i>)] [UNTIL (<i>significant point</i>)];</p> <p>d) DO NOT EXCEED MACH (<i>number</i>).</p> <p>e) CONFIRM ESTABLISHED ON THE TRACK BETWEEN (<i>significant point</i>) AND (<i>significant point</i>) [WITH ZERO OFFSET];</p> <p>*f) ESTABLISHED ON THE TRACK BETWEEN (<i>significant point</i>) AND (<i>significant point</i>) [WITH ZERO OFFSET];</p> <p>g) MAINTAIN TRACK BETWEEN (<i>significant point</i>) AND (<i>significant point</i>). REPORT ESTABLISHED ON THE TRACK;</p> <p>*h) ESTABLISHED ON THE TRACK;</p> <p>i) CONFIRM ZERO OFFSET;</p> <p>*j) AFFIRM ZERO OFFSET.</p> <p>* Denotes pilot transmission.</p>
<p><i>Note.— When used to apply a lateral VOR/GNSS separation confirmation of zero offset is required (see 5.4.1.2).</i></p>	
12.3.2.9 INSTRUCTIONS ASSOCIATED WITH FLYING A TRACK (OFFSET), PARALLEL TO THE CLEARED ROUTE	<p>a) ADVISE IF ABLE TO PROCEED PARALLEL OFFSET;</p> <p>b) PROCEED OFFSET (<i>distance</i>) RIGHT/LEFT OF (<i>route</i>) (<i>track</i>) [CENTRE LINE] [AT (<i>significant point or time</i>)] [UNTIL (<i>significant point or time</i>)];</p> <p>c) CANCEL OFFSET (<i>instructions to rejoin cleared flight route or other information</i>).</p>

12.3.3 Approach control services

<i>Circumstances</i>	<i>Phraseologies</i>
12.3.3.1 DEPARTURE INSTRUCTIONS	<p>a) [AFTER DEPARTURE] TURN RIGHT (or LEFT) HEADING (three digits) (or CONTINUE RUNWAY HEADING) (or TRACK EXTENDED CENTRE LINE) TO (level or significant point) [(other instructions as required)];</p> <p>b) AFTER REACHING (or PASSING) (level or significant point) (instructions);</p> <p>c) TURN RIGHT (or LEFT) HEADING (three digits) TO (level) [TO INTERCEPT (track, route, airway, etc.)];</p> <p>d) (standard departure name and number) DEPARTURE;</p> <p>e) TRACK (three digits) DEGREES [MAGNETIC (or TRUE)] TO (or FROM) (significant point) UNTIL (time, or REACHING (fix or significant point or level)) [BEFORE PROCEEDING ON COURSE];</p> <p>f) CLEARED (designation) DEPARTURE;</p> <p style="text-align: center;"><i>Note.— Conditions associated with the use of this phrase are in Chapter 4, 4.5.7.2.</i></p> <p>g) CLEARED DIRECT (waypoint), CLIMB TO (level), EXPECT TO REJOIN SID [(SID designator)] [AT (waypoint)], <i>then</i> REJOIN SID [(SID designator)] [AT (waypoint)];</p> <p>h) CLEARED DIRECT (waypoint), CLIMB TO (level), <i>then</i> REJOIN SID (SID designator) AT (waypoint).</p>
...clearance to proceed direct with advance notice of a future instruction to rejoin the SID	
12.3.3.2 APPROACH INSTRUCTIONS	<p>a) CLEARED (designation) ARRIVAL;</p> <p>b) CLEARED TO (clearance limit) (designation);</p> <p>c) CLEARED (or PROCEED) (details of route to be followed);</p>

Circumstances	Phraseologies
...clearance to proceed direct with advance notice of a future instruction to rejoin the STAR	<p>d) CLEARED DIRECT (<i>waypoint</i>), DESCEND TO (<i>level</i>), EXPECT TO REJOIN STAR [(<i>STAR designator</i>)] AT (<i>waypoint</i>),</p> <p><i>then</i></p> <p>REJOIN STAR [(<i>STAR designator</i>)] [AT (<i>waypoint</i>)];</p> <p>e) CLEARED DIRECT (<i>waypoint</i>), DESCEND TO (<i>level</i>),</p> <p><i>then</i></p> <p>REJOIN STAR (<i>STAR designator</i>) AT (<i>waypoint</i>);</p> <p>f) CLEARED (<i>type of approach</i>) APPROACH [RUNWAY (<i>number</i>)];</p> <p>g) CLEARED (<i>type of approach</i>) RUNWAY (<i>number</i>) FOLLOWED BY CIRCLING TO RUNWAY (<i>number</i>);</p> <p>h) CLEARED APPROACH [RUNWAY (<i>number</i>)];</p> <p>i) COMMENCE APPROACH AT (<i>time</i>);</p> <p>*j) REQUEST STRAIGHT-IN [(<i>type of approach</i>)] APPROACH [RUNWAY (<i>number</i>)];</p> <p>k) CLEARED STRAIGHT-IN [(<i>type of approach</i>)] APPROACH [RUNWAY (<i>number</i>)];</p> <p>l) REPORT VISUAL;</p> <p>m) REPORT RUNWAY [LIGHTS] IN SIGHT;</p>
... when a pilot requests a visual approach	<p>*n) REQUEST VISUAL APPROACH;</p> <p>o) CLEARED VISUAL APPROACH RUNWAY (<i>number</i>);</p>
... to request if a pilot is able to accept a visual approach	<p>p) ADVISE ABLE TO ACCEPT VISUAL APPROACH RUNWAY (<i>number</i>);</p>
<p><i>Note.—See 6.5.3 for provisions relating to visual approach procedures.</i></p>	

Circumstances	Phraseologies
... in case of successive visual approaches when the pilot of a succeeding aircraft has reported having the preceding aircraft in sight	<p>q) CLEARED VISUAL APPROACH RUNWAY (<i>number</i>), MAINTAIN OWN SEPARATION FROM PRECEDING (<i>aircraft type and wake turbulence category as appropriate</i>) [CAUTION WAKE TURBULENCE];</p> <p>r) REPORT (<i>significant point</i>); [OUTBOUND, <i>or</i> INBOUND];</p> <p>s) REPORT COMMENCING PROCEDURE TURN;</p> <p>*t) REQUEST VMC DESCENT;</p> <p>u) MAINTAIN OWN SEPARATION;</p> <p>v) MAINTAIN VMC;</p> <p>w) ARE YOU FAMILIAR WITH (<i>name</i>) APPROACH PROCEDURE;</p> <p>*x) REQUEST (<i>type of approach</i>) APPROACH [RUNWAY (<i>number</i>)];</p> <p>*y) REQUEST (MLS/RNAV plain-language designator);</p> <p>z) CLEARED (<i>MLS/RNAV plain-language designator</i>).</p> <p>* Denotes pilot transmission.</p>
12.3.3.3 HOLDING CLEARANCES	<p>a) HOLD VISUAL [OVER] (<i>position</i>), (<i>or</i> BETWEEN (<i>two prominent landmarks</i>));</p> <p>b) CLEARED (<i>or</i> PROCEED) TO (<i>significant point, name of facility or fix</i>) [MAINTAIN (<i>or</i> CLIMB <i>or</i> DESCEND TO (<i>level</i>)] HOLD [(<i>direction</i>)] AS PUBLISHED EXPECT APPROACH CLEARANCE (<i>or</i> FURTHER CLEARANCE) AT (<i>time</i>);</p> <p>*c) REQUEST HOLDING INSTRUCTIONS;</p> <p>d) CLEARED (<i>or</i> PROCEED) TO (<i>significant point, name of facility or fix</i>) [MAINTAIN (<i>or</i> CLIMB <i>or</i> DESCEND TO (<i>level</i>)] HOLD [(<i>direction</i>)] [(<i>specified</i>) RADIAL, COURSE, INBOUND TRACK (<i>three digits</i>) DEGREES] [RIGHT (<i>or</i> LEFT) HAND PATTERN] [OUTBOUND TIME (<i>number</i>) MINUTES] EXPECT APPROACH CLEARANCE (<i>or</i> FURTHER CLEARANCE) AT (<i>time</i>) (<i>additional instructions, if necessary</i>);</p>
... visual	
... published holding procedure over a facility or fix	
... when a detailed holding clearance is required	

Circumstances

Phraseologies

- e) CLEARED TO THE *(three digits)* RADIAL OF THE *(name)* VOR AT *(distance)* DME FIX [MAINTAIN *(or CLIMB or DESCEND TO)* *(level)*] HOLD [*(direction)*] [RIGHT *(or LEFT)* HAND PATTERN] [OUTBOUND TIME *(number)* MINUTES] EXPECT APPROACH CLEARANCE *(or FURTHER CLEARANCE)* AT *(time)* *(additional instructions, if necessary)*;
- f) CLEARED TO THE *(three digits)* RADIAL OF THE *(name)* VOR AT *(distance)* DME FIX [MAINTAIN *(or CLIMB or DESCEND TO)* *(level)*] HOLD BETWEEN *(distance)* AND *(distance)* DME [RIGHT *(or LEFT)* HAND PATTERN] EXPECT APPROACH CLEARANCE *(or FURTHER CLEARANCE)* AT *(time)* *(additional instructions, if necessary)*.

* Denotes pilot transmission.

12.3.3.4 EXPECTED APPROACH TIME

- a) NO DELAY EXPECTED;
- b) EXPECTED APPROACH TIME *(time)*;
- c) REVISED EXPECTED APPROACH TIME *(time)*;
- d) DELAY NOT DETERMINED *(reasons)*.

12.3.4 Phraseologies for use on and in the vicinity of the aerodrome

<i>Circumstances</i>	<i>Phraseologies</i>
12.3.4.1 IDENTIFICATION OF AIRCRAFT	SHOW LANDING LIGHTS.
12.3.4.2 ACKNOWLEDGEMENT BY VISUAL MEANS	a) ACKNOWLEDGE BY MOVING AILERONS (<i>or</i> RUDDER); b) ACKNOWLEDGE BY ROCKING WINGS; c) ACKNOWLEDGE BY FLASHING LANDING LIGHTS.
12.3.4.3 STARTING PROCEDURES	
... to request permission to start engines	*a) [<i>aircraft location</i>] REQUEST START UP; *b) [<i>aircraft location</i>] REQUEST START UP, INFORMATION (<i>ATIS identification</i>);
... ATC replies	c) START UP APPROVED; d) START UP AT (<i>time</i>); e) EXPECT START UP AT (<i>time</i>); f) START UP AT OWN DISCRETION; g) EXPECT DEPARTURE (<i>time</i>) START UP AT OWN DISCRETION. * Denotes pilot transmission.
12.3.4.4 PUSHBACK PROCEDURES	
<i>Note.— When local procedures so prescribe, authorization for pushback should be obtained from the control tower.</i>	
... aircraft/ATC	*a) [<i>aircraft location</i>] REQUEST PUSHBACK; b) PUSHBACK APPROVED; c) STAND BY; d) PUSHBACK AT OWN DISCRETION; e) EXPECT (<i>number</i>) MINUTES DELAY DUE (<i>reason</i>). * Denotes pilot transmission.

<i>Circumstances</i>	<i>Phraseologies</i>
12.3.4.5 TOWING PROCEDURES ... ATC response	†a) REQUEST TOW [company name] (aircraft type) FROM (location) TO (location); b) TOW APPROVED VIA (<i>specific routing to be followed</i>); c) HOLD POSITION; d) STAND BY. † Denotes transmission from aircraft/tow vehicle combination.
12.3.4.6 TO REQUEST TIME CHECK AND/OR AERODROME DATA FOR DEPARTURE ... when no ATIS broadcast is available	*a) REQUEST TIME CHECK; b) TIME (<i>time</i>); *c) REQUEST DEPARTURE INFORMATION; d) RUNWAY (<i>number</i>), WIND (<i>direction and speed</i>) (<i>units</i>) QNH (<i>or</i> QFE) (<i>number</i>) [(<i>units</i>)] TEMPERATURE [MINUS] (<i>number</i>), [VISIBILITY (<i>distance</i>) (<i>units</i>) (<i>or</i> RUNWAY VISUAL RANGE (<i>or</i> RVR) (<i>distance</i>) (<i>units</i>))] [TIME (<i>time</i>)]. <i>Note.— If multiple visibility and RVR observations are available, those that represent the roll-out/stop end zone should be used for take-off.</i> * Denotes pilot transmission.
12.3.4.7 TAXI PROCEDURES ... for departure ... where detailed taxi instructions are required	*a) [<i>aircraft type</i>] [<i>wake turbulence category if “heavy”</i>] [<i>aircraft location</i>] REQUEST TAXI [<i>intentions</i>]; *b) [<i>aircraft type</i>] [<i>wake turbulence category if “heavy”</i>] [<i>aircraft location</i>] (<i>flight rules</i>) TO (<i>aerodrome of destination</i>) REQUEST TAXI [<i>intentions</i>]; c) TAXI TO HOLDING POINT [<i>number</i>] [RUNWAY (<i>number</i>)] [HOLD SHORT OF RUNWAY (<i>number</i>) (<i>or</i> CROSS RUNWAY (<i>number</i>))] [TIME (<i>time</i>)]; *d) [<i>aircraft type</i>] [<i>wake turbulence category if “heavy”</i>] REQUEST DETAILED TAXI INSTRUCTIONS;

Circumstances	Phraseologies
... where aerodrome information is not available from an alternative source such as ATIS	<p>e) TAXI TO HOLDING POINT <i>[number]</i> [RUNWAY <i>(number)</i>] VIA <i>(specific route to be followed)</i> [TIME <i>(time)</i>] [HOLD SHORT OF RUNWAY <i>(number)</i> (or CROSS RUNWAY <i>(number)</i>)];</p> <p>f) TAXI TO HOLDING POINT <i>[number]</i> <i>(followed by aerodrome information as applicable)</i> [TIME <i>(time)</i>];</p> <p>g) TAKE (or TURN) FIRST (or SECOND) LEFT (or RIGHT);</p> <p>h) TAXI VIA <i>(identification of taxiway)</i>;</p> <p>i) TAXI VIA RUNWAY <i>(number)</i>;</p> <p>j) TAXI TO TERMINAL (or other location, e.g. GENERAL AVIATION AREA) [STAND <i>(number)</i>];</p>
... for helicopter operations	<p>*k) REQUEST AIR-TAXIING FROM (or VIA) TO <i>(location or routing as appropriate)</i>;</p> <p>l) AIR-TAXI TO (or VIA) <i>(location or routing as appropriate)</i> [CAUTION <i>(dust, blowing snow, loose debris, taxiing light aircraft, personnel, etc.)</i>];</p> <p>m) AIR TAXI VIA <i>(direct, as requested, or specified route)</i> TO <i>(location, heliport, operating or movement area, active or inactive runway)</i>. AVOID <i>(aircraft or vehicles or personnel)</i>;</p>
... after landing	<p>*n) REQUEST BACKTRACK;</p> <p>o) BACKTRACK APPROVED;</p> <p>p) BACKTRACK RUNWAY <i>(number)</i>;</p>
... general	<p>*q) <i>[(aircraft location)]</i> REQUEST TAXI TO <i>(destination on aerodrome)</i>;</p> <p>r) TAXI STRAIGHT AHEAD;</p> <p>s) TAXI WITH CAUTION;</p> <p>t) GIVE WAY TO <i>(description and position of other aircraft)</i>;</p> <p>*u) GIVING WAY TO <i>(traffic)</i>;</p> <p>*v) TRAFFIC (or type of aircraft) IN SIGHT;</p> <p>w) TAXI INTO HOLDING BAY;</p> <p>x) FOLLOW <i>(description of other aircraft or vehicle)</i>;</p>

Circumstances	Phraseologies
	<p>y) VACATE RUNWAY;</p> <p>*z) RUNWAY VACATED;</p> <p>aa) EXPEDITE TAXI [<i>reason</i>];</p> <p>*bb) EXPEDITING;</p> <p>cc) [CAUTION] TAXI SLOWER [<i>reason</i>];</p> <p>*dd) SLOWING DOWN.</p> <p>* Denotes pilot transmission.</p>
<p>12.3.4.8 HOLDING</p> <p>... to hold not closer to a runway than specified in Chapter 7, 7.6.3.1.3.1</p>	<p>‡a) HOLD (<i>direction</i>) OF (<i>position, runway number, etc.</i>);</p> <p>‡b) HOLD POSITION;</p> <p>‡c) HOLD (<i>distance</i>) FROM (<i>position</i>);</p> <p>‡d) HOLD SHORT OF (<i>position</i>);</p> <p>*e) HOLDING;</p> <p>*f) HOLDING SHORT.</p> <p>‡ Requires specific acknowledgement from the pilot.</p> <p>* Denotes pilot transmission. The procedure words ROGER and WILCO are insufficient acknowledgement of the instructions HOLD, HOLD POSITION and HOLD SHORT OF (<i>position</i>). In each case the acknowledgement shall be by the phraseology HOLDING or HOLDING SHORT, as appropriate.</p>
<p>12.3.4.9 TO CROSS A RUNWAY</p>	<p>*a) REQUEST CROSS RUNWAY (<i>number</i>);</p> <p><i>Note.— If the control tower is unable to see the crossing aircraft (e.g. night, low visibility), the instruction should always be accompanied by a request to report when the aircraft has vacated the runway.</i></p> <p>b) CROSS RUNWAY (<i>number</i>) [REPORT VACATED];</p> <p>c) EXPEDITE CROSSING RUNWAY (<i>number</i>) TRAFFIC (<i>aircraft type</i>) (<i>distance</i>) KILOMETRES (<i>or</i>) MILES FINAL;</p> <p>d) TAXI TO HOLDING POINT [<i>number</i>] [RUNWAY (<i>number</i>)] VIA (<i>specific route to be followed</i>), [HOLD SHORT OF RUNWAY (<i>number</i>)] or [CROSS RUNWAY (<i>number</i>)];</p>

Circumstances	Phraseologies
<p><i>Note.— The pilot will, when requested, report “RUNWAY VACATED” when the entire aircraft is beyond the relevant runway-holding position.</i></p>	<p>*e) RUNWAY VACATED.</p> <p>* Denotes pilot transmission.</p>
12.3.4.10 PREPARATION FOR TAKE-OFF	<p>a) UNABLE TO ISSUE (<i>designator</i>) DEPARTURE (<i>reasons</i>);</p> <p>b) REPORT WHEN READY [FOR DEPARTURE];</p> <p>c) ARE YOU READY [FOR DEPARTURE]?;</p> <p>d) ARE YOU READY FOR IMMEDIATE DEPARTURE?;</p> <p>*e) READY;</p>
... clearance to enter runway and await take-off clearance	<p>f) LINE UP [AND WAIT];</p> <p>†g) LINE UP RUNWAY (<i>number</i>);</p> <p>h) LINE UP. BE READY FOR IMMEDIATE DEPARTURE;</p>
... conditional clearances	<p>‡i) (<i>condition</i>) LINE UP (<i>brief reiteration of the condition</i>);</p>
... acknowledgement of a conditional clearance	<p>*j) (<i>condition</i>) LINING UP (<i>brief reiteration of the condition</i>);</p>
... confirmation or otherwise of the readback of conditional clearance	<p>k) [THAT IS] CORRECT (<i>or</i> NEGATIVE) [I SAY AGAIN] ... (<i>as appropriate</i>).</p> <p>* Denotes pilot transmission.</p> <p>† When there is the possibility of confusion during multiple runway operations.</p> <p>‡ Provisions concerning the use of conditional clearances are contained in 12.2.7.</p>
12.3.4.11 TAKE-OFF CLEARANCE	<p>a) RUNWAY (<i>number</i>) CLEARED FOR TAKE-OFF [REPORT AIRBORNE];</p> <p>b) (<i>traffic information</i>) RUNWAY (<i>number</i>) CLEARED FOR TAKE-OFF;</p>
... when reduced runway separation is used	

<i>Circumstances</i>	<i>Phraseologies</i>
... when take-off clearance has not been complied with	c) TAKE OFF IMMEDIATELY OR VACATE RUNWAY [(instructions)];
	d) TAKE OFF IMMEDIATELY OR HOLD SHORT OF RUNWAY;
... to cancel a take-off clearance	e) HOLD POSITION, CANCEL TAKE-OFF I SAY AGAIN CANCEL TAKE-OFF (reasons);
	*f) HOLDING;
... to stop a take-off after an aircraft has commenced take-off roll	g) STOP IMMEDIATELY [(repeat aircraft call sign) STOP IMMEDIATELY];
	*h) STOPPING;
... for helicopter operations	i) CLEARED FOR TAKE-OFF [FROM (location)] (present position, taxiway, final approach and take-off area, runway and number);
	*j) REQUEST DEPARTURE INSTRUCTIONS;
	k) AFTER DEPARTURE TURN RIGHT (or LEFT, or CLIMB) (instructions as appropriate).
	* Denotes pilot transmission. HOLDING and STOPPING are the procedural responses to e) and g) respectively.
12.3.4.12 TURN OR CLIMB INSTRUCTIONS AFTER TAKE-OFF	*a) REQUEST RIGHT (or LEFT) TURN;
	b) RIGHT (or LEFT) TURN APPROVED;
	c) WILL ADVISE LATER FOR RIGHT (or LEFT) TURN;
... to request airborne time	d) REPORT AIRBORNE;
	e) AIRBORNE (time);
	f) AFTER PASSING (level) (instructions);
... heading to be followed	g) CONTINUE RUNWAY HEADING (instructions);
... when a specific track is to be followed	h) TRACK EXTENDED CENTRE LINE (instructions);
	i) CLIMB STRAIGHT AHEAD (instructions).
	* Denotes pilot transmission.

<i>Circumstances</i>	<i>Phraseologies</i>
12.3.4.13 ENTERING AN AERODROME TRAFFIC CIRCUIT	<p>*a) <i>[aircraft type] (position) (level)</i> FOR LANDING;</p> <p>b) JOIN <i>[(direction of circuit)] (position in circuit) (runway number)</i> [SURFACE] WIND <i>(direction and speed) (units)</i> [TEMPERATURE [MINUS] <i>(number)</i>] QNH (or QFE) <i>(number) [(units)]</i> [TRAFFIC <i>(detail)</i>];</p> <p>c) MAKE STRAIGHT-IN APPROACH, RUNWAY <i>(number)</i> [SURFACE] WIND <i>(direction and speed) (units)</i> [TEMPERATURE [MINUS] <i>(number)</i>] QNH (or QFE) <i>(number) [(units)]</i> [TRAFFIC <i>(detail)</i>];</p>
... when ATIS information is available	<p>*d) <i>(aircraft type) (position) (level)</i> INFORMATION (ATIS identification) FOR LANDING;</p> <p>e) JOIN <i>(position in circuit)</i> [RUNWAY <i>(number)</i>] QNH (or QFE) <i>(number) [(units)]</i> [TRAFFIC <i>(detail)</i>].</p> <p>* Denotes pilot transmission.</p>
12.3.4.14 IN THE CIRCUIT	<p>*a) <i>(position in circuit, e.g. DOWNWIND/FINAL)</i>;</p> <p>b) NUMBER ... FOLLOW <i>(aircraft type and position) [additional instructions if required]</i>.</p> <p>* Denotes pilot transmission.</p>
12.3.4.15 APPROACH INSTRUCTIONS	<p>a) MAKE SHORT APPROACH;</p> <p>b) MAKE LONG APPROACH (or EXTEND DOWNWIND);</p> <p>c) REPORT BASE (or FINAL, or LONG FINAL);</p> <p>d) CONTINUE APPROACH [PREPARE FOR POSSIBLE GO AROUND].</p>
12.3.4.16 LANDING CLEARANCE	<p>a) RUNWAY <i>(number)</i> CLEARED TO LAND;</p>
... when reduced runway separation is used	<p>b) <i>(traffic information)</i> RUNWAY <i>(number)</i> CLEARED TO LAND;</p>
... special operations	<p>c) CLEARED TOUCH AND GO;</p> <p>d) MAKE FULL STOP;</p>

<i>Circumstances</i>	<i>Phraseologies</i>
<p>... to make an approach along, or parallel to a runway, descending to an agreed minimum level</p> <p>... to fly past the control tower or other observation point for the purpose of visual inspection by persons on the ground</p> <p>... for helicopter operations</p>	<p>*e) REQUEST LOW APPROACH (<i>reasons</i>);</p> <p>f) CLEARED LOW APPROACH [RUNWAY (<i>number</i>)] [<i>(altitude restriction if required) (go around instructions)</i>];</p> <p>*g) REQUEST LOW PASS (<i>reasons</i>);</p> <p>h) CLEARED LOW PASS [<i>as in f)</i>];</p> <p>*i) REQUEST STRAIGHT-IN (<i>or</i> CIRCLING APPROACH, LEFT (<i>or</i> RIGHT) TURN TO (<i>location</i>));</p> <p>j) MAKE STRAIGHT-IN (<i>or</i> CIRCLING APPROACH, LEFT (<i>or</i> RIGHT) TURN TO (<i>location, runway, taxiway, final approach and take-off area</i>)) [ARRIVAL (<i>or</i> ARRIVAL ROUTE) (<i>number, name, or code</i>)]. [HOLD SHORT OF (<i>active runway, extended runway centre line, other</i>)]. [REMAIN (<i>direction or distance</i>) FROM (<i>runway, runway centre line, other helicopter or aircraft</i>)]. [CAUTION (<i>power lines, unlighted obstructions, wake turbulence, etc.</i>)]. CLEARED TO LAND.</p> <p>* Denotes pilot transmission.</p>
12.3.4.17 DELAYING AIRCRAFT	<p>a) CIRCLE THE AERODROME;</p> <p>b) ORBIT (RIGHT, <i>or</i> LEFT) [FROM PRESENT POSITION];</p> <p>c) MAKE ANOTHER CIRCUIT.</p>
12.3.4.18 MISSED APPROACH	<p>a) GO AROUND;</p> <p>*b) GOING AROUND.</p> <p>* Denotes pilot transmission.</p>
12.3.4.19 INFORMATION TO AIRCRAFT	
<p>... when pilot requested visual inspection of landing gear</p>	<p>a) LANDING GEAR APPEARS DOWN;</p> <p>b) RIGHT (<i>or</i> LEFT, <i>or</i> NOSE) WHEEL APPEARS UP (<i>or</i> DOWN);</p> <p>c) WHEELS APPEAR UP;</p> <p>d) RIGHT (<i>or</i> LEFT, <i>or</i> NOSE) WHEEL DOES NOT APPEAR UP (<i>or</i> DOWN);</p>

<i>Circumstances</i>	<i>Phraseologies</i>
... wake turbulence	e) CAUTION WAKE TURBULENCE [FROM ARRIVING (or DEPARTING) (type of aircraft)] [additional information as required];
... jet blast on apron or taxiway	f) CAUTION JET BLAST;
... propeller-driven aircraft slipstream	g) CAUTION SLIPSTREAM.
12.3.4.20 RUNWAY VACATING AND COMMUNICATIONS AFTER LANDING	a) CONTACT GROUND (frequency);
	b) WHEN VACATED CONTACT GROUND (frequency);
	c) EXPEDITE VACATING;
	d) YOUR STAND (or GATE) (designation);
	e) TAKE (or TURN) FIRST (or SECOND, or CONVENIENT) LEFT (or RIGHT) AND CONTACT GROUND (frequency);
... for helicopter operations	f) AIR-TAXI TO HELICOPTER STAND (or) HELICOPTER PARKING POSITION (area);
	g) AIR-TAXI TO (or VIA) (location or routing as appropriate) [CAUTION (dust, blowing snow, loose debris, taxiing light aircraft, personnel, etc.)];
	h) AIR-TAXI VIA (direct, as requested, or specified route) TO (location, heliport, operating or movement area, active or inactive runway). AVOID (aircraft or vehicles or personnel).

12.3.5 Coordination between ATS units

<i>Circumstances</i>	<i>Phraseologies</i>
12.3.5.1 ESTIMATES AND REVISIONS	a) ESTIMATE [direction of flight] (aircraft call sign) [SQUAWKING (SSR code)] (type) ESTIMATED (significant point) (time) (level) (or DESCENDING FROM (level) TO (level)) [SPEED (filed TAS)] (route) [REMARKS];
... sending unit	b) ESTIMATE (significant point) ON (aircraft call sign);
... receiving unit reply (if flight plan details are not available)	c) NO DETAILS;

<i>Circumstances</i>	<i>Phraseologies</i>
<p>... receiving unit reply (if flight plan details are available)</p> <p>... sending unit reply</p>	<p>(aircraft type) (destination);</p> <p>[SQUAWKING (SSR code)] [ESTIMATED] (significant point) (time) AT (level);</p> <p><i>Note.— In the event that flight plan details are not available the receiving station shall reply to b) NO DETAILS and transmitting station shall pass full estimate as in a).</i></p> <p>d) ESTIMATE UNMANNED FREE BALLOON(S) (identification and classification) ESTIMATED OVER (place) AT (time) REPORTED FLIGHT LEVEL(S) (figure or figures) [or FLIGHT LEVEL UNKNOWN] MOVING (direction) ESTIMATED GROUND SPEED (figure) (other pertinent information, if any);</p> <p>e) REVISION (aircraft call sign) (details as necessary).</p>
12.3.5.2 TRANSFER OF CONTROL	<p>a) REQUEST RELEASE OF (aircraft call sign);</p> <p>b) (aircraft call sign) RELEASED [AT (time)] [conditions/restrictions];</p> <p>c) IS (aircraft call sign) RELEASED [FOR CLIMB (or DESCENT)];</p> <p>d) (aircraft call sign) NOT RELEASED [UNTIL (time or significant point)];</p> <p>e) UNABLE (aircraft call sign) [TRAFFIC IS (details)].</p>
12.3.5.3 CHANGE OF CLEARANCE	<p>a) MAY WE CHANGE CLEARANCE OF (aircraft call sign) TO (details of alteration proposed);</p> <p>b) AGREED TO (alteration of clearance) OF (aircraft call sign);</p> <p>c) UNABLE (aircraft call sign);</p> <p>d) UNABLE (desired route, level, etc.) [FOR (aircraft call sign)] [DUE (reason)] (alternative clearance proposed).</p>
12.3.5.4 APPROVAL REQUEST	<p>a) APPROVAL REQUEST (aircraft call sign) ESTIMATED DEPARTURE FROM (significant point) AT (time);</p> <p>b) (aircraft call sign) REQUEST APPROVED [(restriction if any)];</p> <p>c) (aircraft call sign) UNABLE (alternative instructions).</p>

<i>Circumstances</i>	<i>Phraseologies</i>
12.3.5.5 INBOUND RELEASE	[INBOUND RELEASE] (<i>aircraft call sign</i>) [SQUAWKING (<i>SSR code</i>)] (<i>type</i>) FROM (<i>departure point</i>) RELEASED AT (<i>significant point, or time, or level</i>) CLEARED TO AND ESTIMATING (<i>clearance limit</i>) (<i>time</i>) AT (<i>level</i>) [EXPECTED APPROACH TIME or NO DELAY EXPECTED] CONTACT AT (<i>time</i>).
12.3.5.6 HANDOVER	HANDOVER (<i>aircraft call sign</i>) [SQUAWKING (<i>SSR code</i>)] POSITION (<i>aircraft position</i>) (<i>level</i>).
12.3.5.7 EXPEDITION OF CLEARANCE	a) EXPEDITE CLEARANCE (<i>aircraft call sign</i>) EXPECTED DEPARTURE FROM (<i>place</i>) AT (<i>time</i>); b) EXPEDITE CLEARANCE (<i>aircraft call sign</i>) [ESTIMATED] OVER (<i>place</i>) AT (<i>time</i>) REQUESTS (<i>level or route, etc.</i>).
12.3.5.8 REDUCED VERTICAL SEPARATION MINIMUM (RVSM) OPERATIONS ... to verbally supplement estimate messages of aircraft non-approved for RVSM or to verbally supplement an automated estimate message exchange that does not automatically transfer information from Item 18 of the flight plan followed by supplementary information, as appropriate ... to communicate the cause of a contingency relating to an aircraft that is unable to conduct RVSM operations due to severe turbulence or other severe meteorological phenomena or equipment failure, as applicable	a) NEGATIVE RVSM [(<i>supplementary information, e.g. State aircraft</i>)]; b) UNABLE RVSM DUE TURBULENCE (<i>or EQUIPMENT, as applicable</i>).

12.3.6 Phraseologies to be used related to CPDLC

<i>Circumstances</i>	<i>Phraseologies</i>
12.3.6.1 OPERATIONAL STATUS ... failure of CPDLC ... failure of a single CPDLC message	a) [ALL STATIONS] CPDLC FAILURE (<i>instructions</i>); b) CPDLC MESSAGE FAILURE (<i>appropriate clearance, instruction, information or request</i>);

<i>Circumstances</i>	<i>Phraseologies</i>
... to correct CPDLC clearances, instructions, information or requests	c) DISREGARD CPDLC (<i>message type</i>) MESSAGE, BREAK (<i>correct clearance, instruction, information or request</i>);
... to instruct all stations or a specific flight to avoid sending CPDLC requests for a limited period of time	d) [ALL STATIONS] STOP SENDING CPDLC REQUESTS [UNTIL ADVISED] [<i>reason</i>];
... to resume normal use of CPDLC	e) [ALL STATIONS] RESUME NORMAL CPDLC OPERATIONS.

12.4 ATS SURVEILLANCE SERVICE PHRASEOLOGIES

Note.— The following comprise phraseologies specifically applicable when an ATS surveillance system is used in the provision of air traffic services. The phraseologies detailed in the sections above for use in the provision of air traffic services are also applicable, as appropriate, when an ATS surveillance system is used.

12.4.1 General ATS surveillance service phraseologies

<i>Circumstances</i>	<i>Phraseologies</i>
12.4.1.1 IDENTIFICATION OF AIRCRAFT	a) REPORT HEADING [AND FLIGHT LEVEL (<i>or</i> ALTITUDE)]; b) FOR IDENTIFICATION TURN LEFT (<i>or</i> RIGHT) HEADING (<i>three digits</i>); c) TRANSMIT FOR IDENTIFICATION AND REPORT HEADING; d) RADAR CONTACT [<i>position</i>]; e) IDENTIFIED [<i>position</i>]; f) NOT IDENTIFIED [<i>reason</i>], [RESUME (<i>or</i> CONTINUE) OWN NAVIGATION].
12.4.1.2 POSITION INFORMATION	POSITION (<i>distance</i>) (<i>direction</i>) OF (<i>significant point</i>) (<i>or</i> OVER <i>or</i> ABEAM (<i>significant point</i>)).
12.4.1.3 VECTORING INSTRUCTIONS	a) LEAVE (<i>significant point</i>) HEADING (<i>three digits</i>); b) CONTINUE HEADING (<i>three digits</i>); c) CONTINUE PRESENT HEADING;

Circumstances	Phraseologies
12.4.1.4 TERMINATION OF VECTORING	d) FLY HEADING (<i>three digits</i>); e) TURN LEFT (<i>or RIGHT</i>) HEADING (<i>three digits</i>) [<i>reason</i>]; f) TURN LEFT (<i>or RIGHT</i>) (<i>number of degrees</i>) DEGREES [<i>reason</i>]; g) STOP TURN HEADING (<i>three digits</i>); h) FLY HEADING (<i>three digits</i>), WHEN ABLE PROCEED DIRECT (<i>name</i>) (<i>significant point</i>); i) HEADING IS GOOD.
12.4.1.5 MANOEUVRES	a) RESUME OWN NAVIGATION (<i>position of aircraft</i>) (<i>specific instructions</i>); b) RESUME OWN NAVIGATION [DIRECT] (<i>significant point</i>) [MAGNETIC TRACK (<i>three digits</i>) DISTANCE (<i>number</i>) KILOMETRES (<i>or MILES</i>)].
... (in case of unreliable directional instruments on board aircraft)	a) MAKE A THREE SIXTY TURN LEFT (<i>or RIGHT</i>) [<i>reason</i>]; b) ORBIT LEFT (<i>or RIGHT</i>) [<i>reason</i>]; c) MAKE ALL TURNS RATE ONE (<i>or RATE HALF, or (number) DEGREES PER SECOND</i>) START AND STOP ALL TURNS ON THE COMMAND “NOW”; d) TURN LEFT (<i>or RIGHT</i>) NOW; e) STOP TURN NOW.
<p><i>Note.— When it is necessary to specify a reason for vectoring or for the above manoeuvres, the following phraseologies should be used:</i></p>	a) DUE TRAFFIC; b) FOR SPACING; c) FOR DELAY; d) FOR DOWNWIND (<i>or BASE, or FINAL</i>).
12.4.1.6 SPEED CONTROL	a) REPORT SPEED; *b) SPEED (<i>number</i>) KILOMETRES PER HOUR (<i>or KNOTS</i>); c) MAINTAIN (<i>number</i>) KILOMETRES PER HOUR (<i>or KNOTS</i>) [OR GREATER (<i>or OR LESS</i>)] [UNTIL (<i>significant point</i>)]; d) DO NOT EXCEED (<i>number</i>) KILOMETRES PER HOUR (<i>or KNOTS</i>);

Circumstances	Phraseologies
	<p>e) MAINTAIN PRESENT SPEED;</p> <p>f) INCREASE (or REDUCE) SPEED TO (number) KILOMETRES PER HOUR (or KNOTS) [OR GREATER (or OR LESS)];</p> <p>g) INCREASE (or REDUCE) SPEED BY (number) KILOMETRES PER HOUR (or KNOTS);</p> <p>h) RESUME NORMAL SPEED;</p> <p>i) REDUCE TO MINIMUM APPROACH SPEED;</p> <p>j) REDUCE TO MINIMUM CLEAN SPEED;</p> <p>k) RESUME PUBLISHED SPEED;</p> <p>l) NO [ATC] SPEED RESTRICTIONS.</p> <p>* Denotes pilot transmission.</p>
<p>12.4.1.7 POSITION REPORTING</p> <p>... to omit position reports</p>	<p>a) OMIT POSITION REPORTS [UNTIL (specify)];</p> <p>b) NEXT REPORT AT (significant point);</p> <p>c) REPORTS REQUIRED ONLY AT (significant point(s));</p> <p>d) RESUME POSITION REPORTING.</p>
<p>12.4.1.8 TRAFFIC INFORMATION AND AVOIDING ACTION</p> <p>... (if known)</p>	<p>a) TRAFFIC (number) O’CLOCK (distance) (direction of flight) [any other pertinent information]:</p> <p>1) UNKNOWN;</p> <p>2) SLOW MOVING;</p> <p>3) FAST MOVING;</p> <p>4) CLOSING;</p> <p>5) OPPOSITE (or SAME) DIRECTION;</p> <p>6) OVERTAKING;</p> <p>7) CROSSING LEFT TO RIGHT (or RIGHT TO LEFT);</p> <p>8) (aircraft type);</p>

Circumstances	Phraseologies
... to request avoiding action	9) (level); 10) CLIMBING (or DESCENDING); *b) REQUEST VECTORS; c) DO YOU WANT VECTORS?;
... when passing unknown traffic	d) CLEAR OF TRAFFIC [<i>appropriate instructions</i>];
... for avoiding action	e) TURN LEFT (or RIGHT) IMMEDIATELY HEADING (<i>three digits</i>) TO AVOID [UNIDENTIFIED] TRAFFIC (<i>bearing by clock-reference and distance</i>); f) TURN LEFT (or RIGHT) (<i>number of degrees</i>) DEGREES IMMEDIATELY TO AVOID [UNIDENTIFIED] TRAFFIC AT (<i>bearing by clock-reference and distance</i>).
* Denotes pilot transmission.	
12.4.1.9 COMMUNICATIONS AND LOSS OF COMMUNICATIONS	a) [IF] RADIO CONTACT LOST (<i>instructions</i>); b) IF NO TRANSMISSIONS RECEIVED FOR (<i>number</i>) MINUTES (or SECONDS) (<i>instructions</i>); c) REPLY NOT RECEIVED (<i>instructions</i>); d) IF YOU READ [<i>manoeuvre instructions or SQUAWK (code or IDENT)</i>]; e) (<i>manoeuvre, SQUAWK or IDENT</i>) OBSERVED. POSITION (<i>position of aircraft</i>). [<i>instructions</i>].
... if loss of communications suspected	
12.4.1.10 TERMINATION OF RADAR AND/OR ADS-B SERVICE	a) RADAR SERVICE (or IDENTIFICATION) TERMINATED [DUE (<i>reason</i>)] (<i>instructions</i>); b) WILL SHORTLY LOSE IDENTIFICATION (<i>appropriate instructions or information</i>); c) IDENTIFICATION LOST [<i>reasons</i>] (<i>instructions</i>).
12.4.1.11 RADAR AND/OR ADS-B EQUIPMENT DEGRADATION	a) SECONDARY RADAR OUT OF SERVICE (<i>appropriate information as necessary</i>); b) PRIMARY RADAR OUT OF SERVICE (<i>appropriate information as necessary</i>);

*Circumstances**Phraseologies*

- | | |
|--|--|
| | c) ADS-B OUT OF SERVICE (<i>appropriate information as necessary</i>). |
|--|--|

12.4.2 Radar in approach control service*Circumstances**Phraseologies*

12.4.2.1 VECTORIZING FOR APPROACH

- | | |
|-----------------------------------|---|
| 12.4.2.1 VECTORIZING FOR APPROACH | <ul style="list-style-type: none"> a) VECTORIZING FOR (<i>type of pilot-interpreted aid</i>) APPROACH RUNWAY (<i>number</i>); b) VECTORIZING FOR VISUAL APPROACH RUNWAY (<i>number</i>) REPORT FIELD (<i>or</i> RUNWAY) IN SIGHT; c) VECTORIZING FOR (<i>positioning in the circuit</i>); d) VECTORIZING FOR SURVEILLANCE RADAR APPROACH RUNWAY (<i>number</i>); e) VECTORIZING FOR PRECISION APPROACH RUNWAY (<i>number</i>); f) (<i>type</i>) APPROACH NOT AVAILABLE DUE (<i>reason</i>) (<i>alternative instructions</i>). |
|-----------------------------------|---|

12.4.2.2 VECTORIZING FOR ILS AND OTHER PILOT-INTERPRETED AIDS

... when a pilot wishes to be positioned a specific distance from touchdown

... instructions and information

- | | |
|---|--|
| 12.4.2.2 VECTORIZING FOR ILS AND OTHER PILOT-INTERPRETED AIDS | <ul style="list-style-type: none"> a) POSITION (<i>number</i>) KILOMETRES (<i>or</i> MILES) from (<i>fix</i>). TURN LEFT (<i>or</i> RIGHT) HEADING (<i>three digits</i>); b) YOU WILL INTERCEPT (<i>radio aid or track</i>) (<i>distance</i>) FROM (<i>significant point or TOUCHDOWN</i>); *c) REQUEST (<i>distance</i>) FINAL; d) CLEARED FOR (<i>type of approach</i>) APPROACH RUNWAY (<i>number</i>); e) REPORT ESTABLISHED ON [ILS] LOCALIZER (<i>or</i> ON GBAS/SBAS/MLS APPROACH COURSE); f) CLOSING FROM LEFT (<i>or</i> RIGHT) [REPORT ESTABLISHED]; g) TURN LEFT (<i>or</i> RIGHT) HEADING (<i>three digits</i>) [TO INTERCEPT] <i>or</i> [REPORT ESTABLISHED]; h) EXPECT VECTOR ACROSS (<i>localizer course or radio aid</i>) (<i>reason</i>); |
|---|--|

Circumstances	Phraseologies
	<p>i) THIS TURN WILL TAKE YOU THROUGH (<i>localizer course or radio aid</i>) [<i>reason</i>];</p> <p>j) TAKING YOU THROUGH (<i>localizer course or radio aid</i>) [<i>reason</i>];</p> <p>k) MAINTAIN (<i>altitude</i>) UNTIL GLIDE PATH INTERCEPTION;</p> <p>l) REPORT ESTABLISHED ON GLIDE PATH;</p> <p>m) INTERCEPT (<i>localizer course or radio aid</i>) [REPORT ESTABLISHED].</p> <p>* Denotes pilot transmission.</p>
<p>12.4.2.3 MANOEUVRE DURING INDEPENDENT AND DEPENDENT PARALLEL APPROACHES</p> <p>... for avoidance action when an aircraft is observed penetrating the NTZ</p> <p>... for avoidance action below 120 m (400 ft) above the runway threshold elevation where parallel approach obstacle assessment surfaces (PAOAS) criteria are being applied</p>	<p>a) CLEARED FOR (<i>type of approach</i>) APPROACH RUNWAY (<i>number</i>) LEFT (<i>or</i>) RIGHT);</p> <p>b) YOU HAVE CROSSED THE LOCALIZER (<i>or</i>) GBAS/SBAS/MLS FINAL APPROACH COURSE). TURN LEFT (<i>or</i>) RIGHT) IMMEDIATELY AND RETURN TO THE LOCALIZER (<i>or</i>) GBAS/SBAS/MLS FINAL APPROACH COURSE);</p> <p>c) ILS (<i>or</i>) MLS) RUNWAY (<i>number</i>) LEFT (<i>or</i>) RIGHT) LOCALIZER (<i>or</i>) MLS) FREQUENCY IS (<i>frequency</i>);</p> <p>d) TURN LEFT (<i>or</i>) RIGHT) (<i>number</i>) DEGREES (<i>or</i>) HEADING) (<i>three digits</i>) IMMEDIATELY TO AVOID TRAFFIC [DEVIATING FROM ADJACENT APPROACH], CLIMB TO (<i>altitude</i>);</p> <p>e) CLIMB TO (<i>altitude</i>) IMMEDIATELY TO AVOID TRAFFIC [DEVIATING FROM ADJACENT APPROACH] (<i>further instructions</i>).</p>
<p>12.4.2.4 SURVEILLANCE RADAR APPROACH</p> <p>12.4.2.4.1 PROVISION OF SERVICE</p>	<p>a) THIS WILL BE A SURVEILLANCE RADAR APPROACH RUNWAY (<i>number</i>) TERMINATING AT (<i>distance</i>) FROM TOUCHDOWN, OBSTACLE CLEARANCE ALTITUDE (<i>or</i>) HEIGHT) (<i>number</i>) METRES (<i>or</i>) FEET) CHECK YOUR MINIMA [IN CASE OF GO AROUND (<i>instructions</i>)];</p>

<i>Circumstances</i>	<i>Phraseologies</i>
	b) APPROACH INSTRUCTIONS WILL BE TERMINATED AT <i>(distance)</i> FROM TOUCHDOWN.
12.4.2.4.2 ELEVATION	a) COMMENCE DESCENT NOW [TO MAINTAIN A <i>(number)</i> DEGREE GLIDE PATH]; b) <i>(distance)</i> FROM TOUCHDOWN ALTITUDE <i>(or HEIGHT)</i> SHOULD BE <i>(numbers and units)</i> .
12.4.2.4.3 POSITION	<i>(distance)</i> FROM TOUCHDOWN.
12.4.2.4.4 CHECKS	a) CHECK GEAR DOWN [AND LOCKED]; b) OVER THRESHOLD.
12.4.2.4.5 COMPLETION OF APPROACH	a) REPORT VISUAL; b) REPORT RUNWAY [LIGHTS] IN SIGHT; c) APPROACH COMPLETED [CONTACT <i>(unit)</i>].
12.4.2.5 PAR APPROACH	
12.4.2.5.1 PROVISION OF SERVICE	a) THIS WILL BE A PRECISION RADAR APPROACH RUNWAY <i>(number)</i> ; b) PRECISION APPROACH NOT AVAILABLE DUE <i>(reason)</i> <i>(alternative instructions)</i> ; c) IN CASE OF GO AROUND <i>(instructions)</i> .
12.4.2.5.2 COMMUNICATIONS	a) DO NOT ACKNOWLEDGE FURTHER TRANSMISSIONS; b) REPLY NOT RECEIVED. WILL CONTINUE INSTRUCTIONS.
12.4.2.5.3 AZIMUTH	a) CLOSING [SLOWLY <i>(or QUICKLY)</i>] [FROM THE LEFT <i>(or FROM THE RIGHT)</i>]; b) HEADING IS GOOD; c) ON TRACK; d) SLIGHTLY <i>(or WELL, or GOING)</i> LEFT <i>(or RIGHT)</i> OF TRACK; e) <i>(number)</i> METRES LEFT <i>(or RIGHT)</i> OF TRACK.
12.4.2.5.4 ELEVATION	a) APPROACHING GLIDE PATH;

Circumstances	Phraseologies
	<ul style="list-style-type: none"> b) COMMENCE DESCENT NOW [AT <i>(number)</i> METRES PER SECOND OR <i>(number)</i> FEET PER MINUTE (or ESTABLISH A <i>(number)</i> DEGREE GLIDE PATH)]; c) RATE OF DESCENT IS GOOD; d) ON GLIDE PATH; e) SLIGHTLY (or WELL, or GOING) ABOVE (or BELOW) GLIDE PATH; f) [STILL] <i>(number)</i> METRES (or FEET) TOO HIGH (or TOO LOW); g) ADJUST RATE OF DESCENT; h) COMING BACK [SLOWLY (or QUICKLY)] TO THE GLIDE PATH; i) RESUME NORMAL RATE OF DESCENT; j) ELEVATION ELEMENT UNSERVICEABLE <i>(to be followed by appropriate instructions)</i>; k) <i>(distance)</i> FROM TOUCHDOWN. ALTITUDE (or HEIGHT) SHOULD BE <i>(numbers and units)</i>.
12.4.2.5.5 POSITION	<ul style="list-style-type: none"> a) <i>(distance)</i> FROM TOUCHDOWN; b) OVER APPROACH LIGHTS; c) OVER THRESHOLD.
12.4.2.5.6 CHECKS	<ul style="list-style-type: none"> a) CHECK GEAR DOWN AND LOCKED; b) CHECK DECISION ALTITUDE (or HEIGHT).
12.4.2.5.7 COMPLETION OF APPROACH	<ul style="list-style-type: none"> a) REPORT VISUAL; b) REPORT RUNWAY [LIGHTS] IN SIGHT; c) APPROACH COMPLETED [CONTACT <i>(unit)</i>].

<i>Circumstances</i>	<i>Phraseologies</i>
12.4.2.5.8 MISSED APPROACH	a) CONTINUE VISUALLY OR GO AROUND [<i>missed approach instructions</i>]; b) GO AROUND IMMEDIATELY [<i>missed approach instructions</i>] (<i>reason</i>); c) ARE YOU GOING AROUND?; d) IF GOING AROUND (<i>appropriate instructions</i>); *e) GOING AROUND.
	* Denotes pilot transmission.

12.4.3 Secondary surveillance radar (SSR) and ADS-B phraseologies

<i>Circumstances</i>	<i>Phraseologies</i>
12.4.3.1 TO REQUEST THE CAPABILITY OF THE SSR EQUIPMENT	a) ADVISE TRANSPONDER CAPABILITY; *b) TRANSPONDER (<i>as shown in the flight plan</i>); *c) NEGATIVE TRANSPONDER. * Denotes pilot transmission.
12.4.3.2 TO REQUEST THE CAPABILITY OF THE ADS-B EQUIPMENT	a) ADVISE ADS-B CAPABILITY; *b) ADS-B TRANSMITTER (<i>data link</i>); *c) ADS-B RECEIVER (<i>data link</i>); *d) NEGATIVE ADS-B. * Denotes pilot transmission.
12.4.3.3 TO INSTRUCT SETTING OF TRANSPONDER	a) FOR DEPARTURE SQUAWK (<i>code</i>); b) SQUAWK (<i>code</i>).
12.4.3.4 TO REQUEST THE PILOT TO RESELECT THE ASSIGNED MODE AND CODE	a) RESET SQUAWK [(<i>mode</i>)] (<i>code</i>); *b) RESETTING (<i>mode</i>) (<i>code</i>). * Denotes pilot transmission.

<i>Circumstances</i>	<i>Phraseologies</i>
12.4.3.5 TO REQUEST RESELECTION OF AIRCRAFT IDENTIFICATION	RE-ENTER [ADS-B <i>or</i> MODE S] AIRCRAFT IDENTIFICATION.
12.4.3.6 TO REQUEST THE PILOT TO CONFIRM THE CODE SELECTED ON THE AIRCRAFT'S TRANSPONDER	a) CONFIRM SQUAWK (<i>code</i>); *b) SQUAWKING (<i>code</i>). * Denotes pilot transmission.
12.4.3.7 TO REQUEST THE OPERATION OF THE IDENT FEATURE	a) SQUAWK [(<i>code</i>)] [AND] IDENT; b) SQUAWK LOW; c) SQUAWK NORMAL; d) TRANSMIT ADS-B IDENT.
12.4.3.8 TO REQUEST TEMPORARY SUSPENSION OF TRANSPONDER OPERATION	SQUAWK STANDBY.
12.4.3.9 TO REQUEST EMERGENCY CODE	SQUAWK MAYDAY [CODE SEVEN-SEVEN-ZERO-ZERO].
12.4.3.10 TO REQUEST TERMINATION OF TRANSPONDER AND/OR ADS-B TRANSMITTER OPERATION <i>Note.— Independent operations of Mode S transponder and ADS-B may not be possible in all aircraft (e.g. where ADS-B is solely provided by 1 090 MHz extended squitter emitted from the transponder). In such cases, aircraft may not be able to comply with ATC instructions related to ADS-B operation.</i>	a) STOP SQUAWK [TRANSMIT ADS-B ONLY]; b) STOP ADS-B TRANSMISSION [SQUAWK (<i>code</i>) ONLY].
12.4.3.11 TO REQUEST TRANSMISSION OF PRESSURE-ALTITUDE	a) SQUAWK CHARLIE; b) TRANSMIT ADS-B ALTITUDE.
12.4.3.12 TO REQUEST PRESSURE SETTING CHECK AND CONFIRMATION OF LEVEL	CHECK ALTIMETER SETTING AND CONFIRM (<i>level</i>).
12.4.3.13 TO REQUEST TERMINATION OF PRESSURE-ALTITUDE TRANSMISSION BECAUSE OF FAULTY OPERATION <i>Note.— See Note to paragraph 12.4.3.10.</i>	a) STOP SQUAWK CHARLIE WRONG INDICATION; b) STOP ADS-B ALTITUDE TRANSMISSION [(WRONG INDICATION, <i>or reason</i>)].

<i>Circumstances</i>	<i>Phraseologies</i>
12.4.3.14 TO REQUEST LEVEL CHECK	CONFIRM <i>(level)</i> .

12.5 AUTOMATIC DEPENDENT SURVEILLANCE – CONTRACT (ADS-C) PHRASEOLOGIES

12.5.1 General ADS-C phraseologies

<i>Circumstances</i>	<i>Phraseologies</i>
12.5.1.1 ADS-C DEGRADATION	ADS-C <i>(or ADS-CONTRACT)</i> OUT OF SERVICE <i>(appropriate information as necessary)</i> .

12.6 ALERTING PHRASEOLOGIES

12.6.1 Alerting phraseologies

<i>Circumstances</i>	<i>Phraseologies</i>
12.6.1.1 LOW ALTITUDE WARNING	<i>(aircraft call sign)</i> LOW ALTITUDE WARNING, CHECK YOUR ALTITUDE IMMEDIATELY, QNH IS <i>(number)</i> [<i>(units)</i>]. [THE MINIMUM FLIGHT ALTITUDE IS <i>(altitude)</i>].
12.6.1.2 TERRAIN ALERT	<i>(aircraft call sign)</i> TERRAIN ALERT, <i>(suggested pilot action, if possible)</i> .

12.7 GROUND CREW/FLIGHT CREW PHRASEOLOGIES

12.7.1 Ground crew/flight crew phraseologies

<i>Circumstances</i>	<i>Phraseologies</i>
12.7.1.1 STARTING PROCEDURES (GROUND CREW/COCKPIT)	a) [ARE YOU] READY TO START UP?;

Circumstances

Phraseologies

12.7.1.2 PUSHBACK PROCEDURES

... (ground crew/cockpit)

*b) STARTING NUMBER (*engine number(s)*).

Note 1.— The ground crew should follow this exchange by either a reply on the intercom or a distinct visual signal to indicate that all is clear and that the start-up as indicated may proceed.

Note 2.— Unambiguous identification of the parties concerned is essential in any communications between ground crew and pilots.

* Denotes pilot transmission.

a) ARE YOU READY FOR PUSHBACK?;

*b) READY FOR PUSHBACK;

c) CONFIRM BRAKES RELEASED;

*d) BRAKES RELEASED;

e) COMMENCING PUSHBACK;

f) PUSHBACK COMPLETED;

*g) STOP PUSHBACK;

h) CONFIRM BRAKES SET;

*i) BRAKES SET;

*j) DISCONNECT;

k) DISCONNECTING STAND BY FOR VISUAL AT YOUR LEFT (*or* RIGHT).

Note.— This exchange is followed by a visual signal to the pilot to indicate that disconnect is completed and all is clear for taxiing.

* Denotes pilot transmission.

12.7.2 De/anti-icing operations

<i>Circumstances</i>	<i>Phraseologies</i>
12.7.2.1 PRIOR TO DE-ICING/ANTI-ICING (GROUND CREW (ICEMAN) / FLIGHT CREW) ...aircraft configuration confirmation	<p>a) STANDING BY TO DE-ICE. CONFIRM BRAKES SET AND TREATMENT REQUIRED;</p> <p>*b) [AFFIRM] BRAKES SET, REQUEST (<i>type of de/anti-icing treatment and areas to be treated</i>);</p> <p>c) HOLD POSITION AND CONFIRM AIRCRAFT CONFIGURED;</p> <p>*d) [AFFIRM] AIRCRAFT CONFIGURED, READY FOR DE-ICING;</p> <p>e) DE-ICING STARTS NOW.</p> <p>* Denotes pilot transmission.</p>
12.7.2.2 UPON CONCLUDING DE-ICING/ANTI-ICING PROCEDURE ...for de-icing operation	<p>a) DE-ICING ON (<i>areas treated</i>) COMPLETE. ADVISE WHEN READY FOR INFORMATION;</p> <p>b) TYPE OF FLUID (<i>Type I or II or III or IV</i>);</p> <p>c) HOLDOVER TIME STARTED AT (<i>time</i>);</p> <p>d) ANTI-ICING CODE (<i>appropriate anti-icing code</i>)</p> <p><i>Note.— Anti-icing code example:</i></p> <p><i>A de-icing/anti-icing procedure whose last step is the use of a mixture of 75% of a Type II fluid and 25% water, commencing at 13:35 local time, is recorded as follows:</i></p> <p style="padding-left: 40px;"><i>TYPE II/75 13:35 (followed by complete name of anti-icing fluid)</i></p>
...for a two-step de-icing/anti-icing operation	<p>e) FINAL STEP STARTED AT (<i>time</i>);</p>
... De-icing/anti-icing complete	<p>f) POST DE-ICING CHECK COMPLETED;</p> <p>g) PERSONNEL AND EQUIPMENT CLEAR OF AIRCRAFT;</p>

12.7.2.3 ABNORMAL OPERATIONS

... for spray nozzle proximity sensor activation

a) BE ADVISED NOZZLE PROXIMITY ACTIVATION ON *(significant point on aircraft)* [NO VISUAL DAMAGE *or* DAMAGE *(description of damage)* OBSERVED] [SAY INTENTIONS];

... for other aircraft having an emergency on the de-icing bay

b) EMERGENCY IN DE-ICING BAY *(de-icing bay number)* [SHUT DOWN ENGINES *or* STANDBY FOR FURTHER INSTRUCTIONS].

Chapter 13

AUTOMATIC DEPENDENT SURVEILLANCE — CONTRACT (ADS-C) SERVICES

13.1 GENERAL

Note.— *Guidance material concerning the implementation of ADS-C is contained in the Global Operational Data Link (GOLD) Manual (Doc 10037).*

The provision of air traffic services to aircraft, based on information received from aircraft via ADS-C, is generally referred to as the provision of ADS-C services.

13.2 ADS-C GROUND SYSTEM CAPABILITIES

13.2.1 ADS-C ground systems used in the provision of air traffic services shall have a very high level of reliability, availability and integrity. The possibility of system failures or significant system degradations that may cause complete or partial interruptions of service shall be very remote. Backup facilities shall be provided.

Note 1.— *An ADS-C ground system will normally consist of a number of integrated elements, including communication interfaces, a data-processing system and one or more controller interfaces.*

Note 2.— *Information pertaining to use of ADS-C and to system reliability, availability and integrity is contained in the Performance-based Communication and Surveillance (PBCS) Manual (Doc 9869).*

13.2.2 ADS-C ground systems should be capable of integration with other automated systems used in the provision of ATS and should provide for an appropriate level of automation with the objectives of improving the accuracy and timeliness of data displayed to the controller and reducing controller workload and the need for verbal coordination between adjacent control positions and ATC units.

13.2.3 Several significant functional requirements are necessary to permit the effective implementation of an ADS-C service in a CNS/ATM environment. Ground systems shall provide for:

- a) the transmitting, receiving, processing and displaying of ADS-C messages related to flights equipped for and operating within environments where ADS-C services are being provided;
- b) the display of safety-related alerts and warnings;
- c) position monitoring (the aircraft's current position as derived from ADS-C reports is displayed to the controller for air traffic situation monitoring);
- d) conformance monitoring (the ADS-C reported current position or projected profile is compared to the expected aircraft position, which is based on the current flight plan. Along track, lateral and vertical deviations that exceed a pre-defined tolerance limit will permit an out-of-conformance alert to be issued to the controller);

- e) flight plan update (e.g. longitudinal variations that exceed pre-defined tolerance limits will be used to adjust expected arrival times at subsequent fixes);
- f) intent validation (intent data contained in ADS-C reports, such as extended projected profile, are compared with the current clearance and discrepancies are identified);
- g) conflict detection (the ADS-C data can be used by the ADS-C ground system automation to identify violations of separation minima);
- h) conflict prediction (the ADS-C position data can be used by the ADS-C ground system automation to identify potential violations of separation minima);
- i) tracking (the tracking function is intended to extrapolate the current position of the aircraft based on ADS-C reports);
- j) wind estimation (ADS-C reports containing wind data may be used to update wind forecasts and hence expected arrival times at waypoints); and
- k) flight management (ADS-C reports may assist automation in generating optimum conflict-free clearances to support possible fuel-saving techniques, such as cruise climbs, requested by the operators).

Note.— The use of ADS-C does not relieve the controller of the obligation to continuously monitor the traffic situation.

13.2.4 The sharing of ADS-C information should be facilitated to the extent possible, in order to extend and improve surveillance in adjacent control areas, thereby reducing the need for additional ADS contracts to be supported by a given aircraft.

13.2.5 Automated exchange of coordination data relevant to aircraft being provided with an ADS-C service, and the establishment of automated coordination procedures shall be provided for on the basis of regional air navigation agreements.

13.2.6 Air traffic control facilities providing an ADS-C service shall be capable of storing and disseminating specific flight information relating to flights equipped for and operating within environments where an ADS-C service is provided.

13.2.7 Effective human-machine interfaces shall exist for the controller to permit appropriate utilization of the ADS-C-derived information and associated automated features.

13.3 ADS-C-RELATED AERONAUTICAL INFORMATION

Adequate information on the operating practices having a direct effect on the operations of air traffic services shall be published in aeronautical information publications. This shall include a brief description concerning the area of responsibility, requirements and conditions under which the ADS-C service is available, equipment limitations, ADS-C failure procedures, if required, and the initial address(es) for each ATC unit.

13.4 USE OF ADS-C IN THE PROVISION OF AIR TRAFFIC CONTROL SERVICE

13.4.1 General

13.4.1.1 ADS-C may be used in the provision of an air traffic control service, provided identification of the aircraft is unambiguously established.

13.4.1.2 Flight data processing of ADS-C data may be used in the provision of an air traffic control service, provided the correlation between the ADS-C data downlinked by that aircraft and the flight plan details held for the aircraft has been accomplished.

Note.— A combination of information received from the aircraft may be necessary to ensure unambiguous correlation, e.g. departure aerodrome, estimated off-block time (EOBT), and destination aerodrome might be used.

13.4.1.3 Human Factors principles shall be observed. In particular, the controller shall be provided with enough information to:

- a) maintain situational awareness; and
- b) be capable of assuming, in the event of system malfunction, the minimum tasks for the provision of an air traffic control service, normally performed by automation.

Note 1.— Automated systems, while designed to provide high operational integrity, remain susceptible to error and failure. Human participation is integral to the safety of the air traffic system.

Note 2.— Guidance material on Human Factors principles can be found in the Human Factors Training Manual (Doc 9683), Human Factors Digest No. 8 — Human Factors in Air Traffic Control (Circular 241), and Human Factors Digest No. 11 — Human Factors in CNS/ATM Systems (Circular 249).

13.4.1.4 Information provided by the ground system may be used by the controller to perform the following functions in the provision of air traffic control services:

- a) enhance safety;
- b) maintain an accurate awareness of the air traffic situation;
- c) apply separation minima;
- d) take appropriate action regarding any significant deviation by aircraft from the terms of their respective air traffic control clearances, including their cleared routes, levels and speed when appropriate;

Note.— Where tolerances regarding such matters as adherence to 3-D position, speed or time have been prescribed by the appropriate ATS authority, deviations are not considered significant until such tolerances are exceeded.

- e) provide updated position information regarding aircraft to other controllers when required; and
- f) improve airspace utilization, reduce delays, as well as provide for direct routings and more optimum flight profiles.

13.4.2 Presentation of ADS-C data

13.4.2.1 Appropriate ADS-C data shall be presented to the controller in a manner suitable to achieve the control functions in 13.4.1.4. Display systems shall incorporate a situation display, textual information display, aural and visual alerts in such combinations as deemed appropriate.

13.4.2.2 Display systems may display actual ADS-C report information only or a combination of actual ADS-C report information and data derived from ADS-C reports. Additionally, display systems may incorporate surveillance information from a number of other sources, including data derived from radar, ADS-B, the flight data processing system (FDPS) and/or CPDLC or voice position reports.

13.4.2.2.1 Where surveillance information is derived from different sources, the type of surveillance shall be readily apparent to the controller.

13.4.2.3 ADS information available to the controller on a situation display shall, as a minimum, include ADS position indications and map information.

13.4.2.3.1 When applicable, distinct symbols should be used to differentiate presentation of position indications which are derived from:

- a) ADS-C position reports; or
- b) combinations of ADS-C with information derived from other surveillance sources, e.g. PSR, SSR, ADS-B; or
- c) ADS-C extrapolations.

13.4.2.3.2 Labels used to provide ADS-C-derived information and any other information that may be available shall, as a minimum, be displayed in alphanumeric form.

13.4.2.3.3 Label information shall, as a minimum, include aircraft identification and level information. All label information shall be presented in a clear and concise manner. Labels shall be associated with their ADS-C position indications in a manner precluding erroneous identification.

13.4.2.4 When ADS-C reports are queued, the controller shall be given an indication that more urgent reports are available based on the following order of priority:

- a) emergency and/or urgency mode ADS-C reports;
- b) event or demand ADS-C reports; and then
- c) periodic ADS-C reports.

13.4.2.4.1 If more than one ADS-C report is queued in any one of a), b) or c) above, they shall be handled in the order received.

13.4.2.5 Safety-related alerts and warnings, including emergency/urgent reports, shall be presented in a clear and distinct manner. Provisions shall be made for alerting the controller when expected ADS-C reports are not received within an appropriate time.

Note.— Non-receipt of ADS-C event contract reports may be undetectable.

13.4.3 Provision of ADS-C services

13.4.3.1 GENERAL

The number of aircraft simultaneously provided with ADS-C services shall not exceed that which can safely be handled under the prevailing circumstances, taking into account:

- a) the complexity of the traffic situation and associated workload within the sector or area of responsibility of the controller;
- b) the level of automation of the ADS-C ground system;
- c) the overall technical performance of the ADS-C systems and communications systems, including possible degradations that would require use of backup facilities;
- d) the overall performance of the backup surveillance and communications systems; and
- e) the effect of loss of controller-pilot communications.

13.4.3.2 COORDINATION AND TRANSFER OF CONTROL OF ADS-C AIRCRAFT

13.4.3.2.1 Appropriate arrangements shall be made in and between any ATC units using ADS-C to ensure the coordination of ADS-C and non-ADS-C traffic and to ensure the provision of adequate separation between the ADS-C aircraft and all other aircraft.

13.4.3.2.2 Transfer of control shall be effected so as to facilitate uninterrupted provision of ADS-C services where ADS-C is available in adjacent ATC units.

13.4.3.2.3 The accepting ATC unit shall establish a contract with the affected aircraft prior to reaching the transfer of control point. Should the accepting ATC unit be unable to establish a contract, the transferring ATC unit shall be notified in order to provide ground forwarding of ADS-C data to permit an uninterrupted ADS-C service.

13.4.3.2.4 When an aircraft is in an emergency/urgency mode or is the subject of safety alerts or warnings, this information shall be provided to the accepting ATC unit, and the ADS contract shall not be terminated by the transferring ATC unit until appropriate coordination has been effected.

13.4.3.2.5 Transfer of control of aircraft between adjacent control positions or between adjacent ATC units may be effected as follows:

- a) appropriate ADS-C transfer protocols are observed by:
 - 1) designation of the ADS-C position indication by automated means; or
 - 2) direct designation of the ADS-C position indication if two display systems are adjacent or if a common (conference) type of display is used; or
 - 3) designation of the ADS-C position indication by reference to a position accurately indicated on both display systems;
- b) updated flight plan information on the aircraft about to be transferred is provided to the accepting controller prior to transfer;

- c) when controllers are not physically adjacent, direct communications facilities are available between them at all times;

Note.— This requirement may be met by two-way direct speech facilities or ATS interfacility data communications (AIDC).

- d) the transfer point or points and all other conditions of application have been made the subject of specific instructions or a specific letter of agreement; and
- e) the accepting controller is kept current of all control instructions (e.g. level or speed instructions) given to the aircraft prior to its transfer and which modify its anticipated flight progress.

Note.— This requirement may be met by two-way direct speech facilities or ATS interfacility data communications (AIDC).

13.4.3.2.6 The minimum agreed separation between aircraft about to be transferred shall be as specified in letters of agreement or local instructions, as appropriate.

13.4.3.3 COMMUNICATIONS

Controller-pilot communications shall be such that the possibility of communications failure or significant degradations is very remote. Adequate backup facilities shall be provided.

13.4.3.4 GENERAL ADS-C PROCEDURES

13.4.3.4.1 ADS CONTRACT MANAGEMENT

13.4.3.4.1.1 Only appropriate ATC units shall initiate ADS contracts with a given aircraft. Procedures shall ensure that non-current contracts are terminated in a timely manner.

13.4.3.4.1.2 The ADS-C ground system shall be able to identify the ADS-C capability of the aircraft and establish appropriate ADS contracts with ADS-C-equipped aircraft.

13.4.3.4.1.3 ADS contracts necessary for the control of the aircraft will be established with each aircraft by the relevant ADS-C ground system, at least for the portions of the aircraft flight over which that ATC unit provides air traffic services.

13.4.3.4.1.4 The contract may include the provision of basic ADS-C reports at a periodic interval defined by the ADS-C ground system with, optionally, additional data containing specific information, which may or may not be sent with each periodic report. The agreement may also provide for ADS-C reports at geographically defined points such as waypoints, in addition to other specific event-driven reports.

13.4.3.4.1.5 The aircraft must be capable of supporting ADS-C agreements with at least four ATC unit ADS-C ground systems simultaneously.

13.4.3.4.1.5.1 When an ADS-C ground system attempts to establish an ADS-C agreement with an aircraft and is unable to do so due to the aircraft's inability to support an additional ADS contract, the aircraft should reply with the

ICAO location indicators or eight-letter facility indicators of the ground systems with which it currently has contracts, in order for the ATC unit to negotiate a contract release. In the event that this information cannot be provided to the ground system, the ground system shall nevertheless alert the controller that an ADS agreement cannot be established. Coordination between the appropriate ATC units shall then be effected for the purpose of establishing priority for ADS-C connections with the aircraft.

13.4.3.4.1.6 An ATC unit shall be capable of replacing or terminating its own ADS contract(s) as required. An existing contract shall remain in place until any new contract of the same type is accepted by the aircraft or until the contract type is terminated.

13.4.3.4.2 ADS-C TERMINATION

13.4.3.4.2.1 ADS contracts may be terminated manually, or automatically by the ADS-C ground system, based on agreements between ATS authorities for aircraft crossing FIR boundaries.

13.4.3.4.2.2 ATS authorities shall establish procedures to ensure that ADS contracts are re-established as required when unplanned ADS-C termination occurs.

13.4.3.4.3 ADS-C AGREEMENTS

13.4.3.4.3.1 Except as provided for in 13.4.3.4.3.2, initial ADS-C agreements shall be determined by the ATS authority. Subsequent modifications to individual contracts may be made at the discretion of the ATS unit.

13.4.3.4.3.2 In airspace where procedural separation is being applied, ADS-C agreements shall, as a minimum, contain the following ADS contracts:

- a) a periodic contract at an interval appropriate to the airspace requirements;
- b) an event contract, specifying the following:
 - 1) a waypoint change event;
 - 2) a lateral deviation event; and
 - 3) a level range deviation event.

Note.— A vertical rate change event specified at, for example, a negative vertical rate (i.e. a descent) exceeding 27 m/s (5 000 ft/min), may provide an additional indication of an abnormal situation.

13.4.3.4.3.3 Upon receipt of an event report indicating a deviation from the clearance, the ATC unit shall establish a periodic contract at a reduced reporting interval, as deemed appropriate, requesting the ground vector data block in addition to basic ADS-C data block. The ATC unit shall advise the flight crew of the observed deviation and ascertain its intention using CPDLC or voice, as appropriate.

13.4.3.4.3.4 The reduced ADS-C periodic reporting interval shall be retained until the aircraft has resumed its clearance, at which time the event contract shall be re-established and the normal periodic contract restored. Action should be taken by the ATC unit to notify proximate aircraft if appropriate.

13.4.3.4.3.5 When the application of specified separation minima is dependent on the reporting interval of periodic position reports, the ATC unit shall not establish periodic contracts with a reporting interval greater than the required reporting interval.

13.4.3.4.3.6 Where an expected position report is not received within a prescribed time parameter, action shall be taken, as appropriate, to ascertain the position of the aircraft.

Note 1.— This may be achieved by the use of an ADS demand contract, CPDLC or voice communications, or receipt of a subsequent periodic report.

Note 2.— Requirements concerning the provision of an alerting service are contained in Chapter 9.

13.4.3.4.4 PERFORMANCE CHECKS

13.4.3.4.4.1 An ATC unit providing an ADS-C service to an aircraft shall check the ADS-C three-dimensional position information received from that aircraft through pilot reports and/or flight plan conformance.

13.4.3.4.4.2 The pilot of the aircraft whose ADS-C-derived position information is within the approved tolerance value need not be advised of such verification.

13.4.3.4.4.3 If the displayed position information is not within the approved tolerance value, or when a discrepancy in excess of the approved tolerance value is detected subsequent to verification, the pilot shall be advised accordingly and requested to check the aircraft's navigation system.

13.4.3.4.4.4 The controller shall adjust the display(s) and carry out adequate checks on the accuracy thereof, in accordance with instructions prescribed by the appropriate authority responsible for the ADS-C display or integrated display system concerned.

13.4.3.4.4.5 The controller shall be satisfied that the functional capabilities of the ADS-C display system or integrated display system, as well as the information displayed, is adequate for the functions to be performed.

13.4.3.4.4.6 The controller shall report, in accordance with local procedures, any fault in the equipment or any incident requiring investigation or any circumstances which make it difficult or impractical to provide services on the basis of displayed ADS-C positions.

13.4.3.4.5 EMERGENCY REPORTS

Note.— To indicate that it is in a state of emergency or the state of emergency is terminated, an aircraft equipped with ADS-C might operate the emergency mode as follows:

- a) *emergency; and*
- b) *emergency cancelled.*

13.4.3.4.5.1 When an ADS-C report is received with an emergency status indication, the controller with responsibility for the flight must acknowledge receipt of the information by the most appropriate means of communication.

13.4.3.4.5.2 Both the aircraft and the ADS-C ground system shall be capable of supporting an emergency mode of ADS-C operation to assist ATC alerting procedures and to assist search and rescue operations. In the event of an aircraft in, or appearing to be in, any form of emergency, all possible assistance shall be provided by the controller.

Note.— The ADS-C airborne system will provide for a pilot-initiated emergency mode. It may also permit the aircraft to automatically establish the emergency mode.

13.4.3.4.5.3 The ADS-C ground system shall recognize the initiation, modification and termination of an emergency mode and alert the controller. The ADS-C ground system shall be able to modify the emergency reporting rate if necessary. The ADS-C ground system shall be able to suppress an emergency indication.

13.4.3.4.6 FAILURE OF EQUIPMENT

Note.— It is not expected that the pilot will be made aware of any failure of ADS-C by means of on-board monitoring equipment.

13.4.3.4.6.1 ADS-C airborne system failure

13.4.3.4.6.1.1 On receipt of an airborne failure notification, the controller will:

- a) advise the pilot of the failure;
- b) advise the pilot of the requirement for position reports via voice or CPDLC; and
- c) take necessary action to establish alternative separation, if required.

13.4.3.4.6.1.2 When an aircraft experiencing ADS-C failure after departure is operating or expected to operate in an area where the carriage of functional ADS-C with specified capabilities is mandatory, the ATC units concerned should endeavour to provide for continuation of the flight to the aerodrome of first intended landing in accordance with the flight plan. However, under some circumstances, continuation of the flight may not be possible due to traffic or airspace configuration. The aircraft may then be required to return to the departure aerodrome or to land at the nearest suitable aerodrome acceptable to the operator concerned.

13.4.3.4.6.1.3 In the case of an ADS-C failure that is detected before departure from an aerodrome where it is not practicable to effect a repair, the aircraft concerned should be permitted to proceed, as directly as possible, to the nearest suitable aerodrome where repair can be made. When granting clearance to such aircraft, the air traffic control unit should take into consideration the existing or anticipated traffic situation and may have to modify the time of departure, flight level or route of the intended flight. Subsequent adjustments may become necessary during the course of the flight.

13.4.3.4.6.2 ADS-C ground system shutdown

13.4.3.4.6.2.1 When a planned shutdown of the ADS-C ground system occurs:

- a) a NOTAM shall be published to inform all affected parties of the shutdown period;
- b) position reports via voice or CPDLC shall be stipulated; and
- c) alternative separation shall be established, if required.

13.4.3.4.6.2.2 In the event of an unplanned ADS-C ground system shutdown, the relevant ATS provider shall:

- a) inform all affected aircraft and advise them of the requirement for position reports via voice or CPDLC;
- b) take necessary action to establish alternative separation, if required;
- c) inform the adjacent ATS unit(s) by direct coordination; and
- d) inform all other relevant parties via the publication of a NOTAM, if appropriate.

13.5 USE OF ADS-C IN THE APPLICATION OF SEPARATION MINIMA

13.5.1 General

Note.— In an ADS-C-based air traffic control (ATC) system, the accuracy of the positional information displayed to the controller is dependent upon the aircraft's on-board navigation or positioning system. Therefore, any aircraft system degradation that affects the aircraft's navigational capabilities will also affect the accuracy of the positional data displayed to the controller.

13.5.1.1 The procedures and minima in this section are applicable when ADS-C is used in the provision of air traffic control services.

13.5.1.1.1 The use of ADS-C position reports to ensure separation shall only be applied when there is a reasonable assurance that the provision of ADS-C reports will not be interrupted.

13.5.2 Determination of level occupancy

13.5.2.1 The tolerance value which shall be used to determine that the ADS-C level information displayed to the controller is accurate shall be ± 60 m (± 200 ft) in RVSM airspace. In other airspace, it shall be ± 90 m (± 300 ft), except that appropriate ATS authorities may specify a smaller criterion, but not less than ± 60 m (± 200 ft), if this is found to be more practical.

13.5.2.2 If the ADS-C level information is not within the approved tolerance value, the information must be validated by voice or CPDLC. Where it has been established that the ADS-C level information is incorrect, the appropriate ATS authority shall determine the action to be taken regarding the display and use of this information.

13.5.2.3 An aircraft cleared to leave a level is considered to have commenced its manoeuvre and vacated the previously occupied level when the ADS level information indicates a change of more than 90 m (300 ft) in the anticipated direction from its previously assigned level, or verification has been made by receipt of a CPDLC or voice report from the pilot.

13.5.2.4 An aircraft that is climbing or descending is considered to have crossed a level when the ADS-C level information indicates that it has passed this level in the required direction by more than 90 m (300 ft) or that verification has been made by receipt of a CPDLC or voice report from the pilot.

13.5.2.5 An aircraft that is climbing or descending is considered to have reached the level to which it has been cleared when verification has been made by receipt of the assigned level by CPDLC or a voice report from the pilot. The aircraft may then be considered to be maintaining this level for as long as the ADS-C level information remains within the appropriate tolerance values as specified in 13.5.2.1.

Note.— A level range deviation event contract may be used to monitor the continued compliance of the aircraft with the appropriate level tolerance values.

13.5.2.5.1 When CPDLC is to be used to verify that the aircraft has reached the level to which it has been cleared, the uplink message No. 129, REPORT MAINTAINING (*level*), or uplink message No. 200, REPORT REACHING, should be used.

*Note.— Uplink message No. 175, REPORT REACHING (*level*), does not provide the same assurance that the aircraft has maintained the assigned level. On those occasions where the flight management system has been loaded by*

the pilot to reply automatically to this message, the reply may be sent when the aircraft reaches the assigned level, irrespective of whether the aircraft maintains the assigned level.

13.5.2.6 Where it is intended to provide vertical separation below a transition level using ADS-C level information, the appropriate authority shall ensure that such information is corrected to the appropriate barometric altitude.

13.5.3 Application of horizontal separation using ADS-C position information

Note 1.— Factors that the controller must take into account in determining the spacing to be applied in particular circumstances in order to ensure that the separation minimum is not infringed include aircraft relative headings and speeds, ADS-C technical limitations, controller workload and any difficulties caused by communications congestion.

Note 2.— Information on the determination and application of separation minima is contained in the Manual on Airspace Planning Methodology for the Determination of Separation Minima (Doc 9689).

13.5.3.1 ADS-C-based longitudinal distance separation minima are detailed at 5.4.2.9 of Chapter 5.

13.5.3.2 ATS authorities shall ensure that contingency procedures are available to be followed in the event of degradation of ADS-C information due to a loss of the required navigation performance accuracy.

13.5.3.3 Distance-based separation minima for use with ADS-C may be applied between ADS-C-derived aircraft positions, or between ADS-C-derived positions and radar or ADS-B-derived positions. The positions of the aircraft shall be extrapolated or interpolated, as necessary, to ensure that they represent the positions of the aircraft at a common time.

13.5.3.3.1 Displayed ADS-C position symbols should enable the controller to distinguish between reported, extrapolated or interpolated positions. When there is any doubt regarding the integrity of the information displayed as an extrapolated or interpolated position symbol, it shall be updated by a demand contract request.

13.5.3.3.2 ADS-C-based separation shall not be applied between aircraft holding over the same holding fix. Application of horizontal separation between holding aircraft and other flights shall be subject to requirements and procedures prescribed by the appropriate ATS authority.

13.5.3.4 Information derived from the display of ADS-C information shall not be used to vector an aircraft.

Note.— Vectoring using ADS-C may be possible in the future in cases where the surveillance and communications performance are comparable to the performance of radar systems and direct voice communications using VHF.

Chapter 14

CONTROLLER-PILOT DATA LINK COMMUNICATIONS (CPDLC)

14.1 GENERAL

Note 1.— Provisions concerning CPDLC are contained in Annex 10, Volume II, Chapter 8.

Note 2.— Guidance material concerning the implementation of CPDLC is contained in the Global Operational Data Link (GOLD) Manual (Doc 10037).

14.1.1 CPDLC provides a means of communication between the controller and pilot, using the CPDLC message set for ATC communication.

14.1.2 This application includes a set of clearance/information/request message elements which correspond to the phraseologies used in the radiotelephony environment.

Note 1.— See Appendix 5 for the CPDLC message set which lists the message elements and their respective message intended use.

Note 2.— Message element intent and text and associated procedures are, in general, consistent with Chapter 12 — Phraseologies. It is, however, recognized that the CPDLC message set and the associated procedures differ somewhat from the voice equivalent used because of the differences between the two media.

14.1.3 The pilot and the controller shall be provided with the capability to exchange messages which include standard message elements, free text message elements or combinations of both.

14.1.4 Ground and airborne systems shall allow for messages to be appropriately displayed, printed when required and stored in a manner that permits timely and convenient retrieval should such action be necessary.

14.1.5 Whenever textual presentation is required, the English language shall be displayed as a minimum.

14.2 ESTABLISHMENT OF CPDLC

14.2.1 General

CPDLC shall be established in sufficient time to ensure that the aircraft is communicating with the appropriate ATC unit. Information concerning when and, where applicable, where, the air or ground systems should establish CPDLC, shall be published in aeronautical information publications.

14.2.2 Airborne-initiated CPDLC

14.2.2.1 When an ATC unit receives an unexpected request for CPDLC from an aircraft, the circumstances leading to the request shall be obtained from the aircraft to determine further action.

14.2.2.2 When the ATC unit rejects a request for CPDLC, it shall provide the pilot with the reason for the rejection using an appropriate CPDLC message.

14.2.3 ATC unit-initiated CPDLC

14.2.3.1 An ATC unit shall only establish CPDLC with an aircraft if the aircraft has no CPDLC link established, or when authorized by the ATC unit currently having CPDLC established with the aircraft.

14.2.3.2 When a request for CPDLC is rejected by an aircraft, the reason for the rejection shall be provided using CPDLC downlink message element NOT CURRENT DATA AUTHORITY or message element NOT AUTHORIZED NEXT DATA AUTHORITY, as appropriate. Local procedures shall dictate whether the reason for rejection is presented to the controller. No other reasons for airborne rejection of ATC unit-initiation of CPDLC shall be permitted.

14.3 EXCHANGE OF OPERATIONAL CPDLC MESSAGES

14.3.1 The controller or pilot shall construct CPDLC messages using standard message elements, free text message elements or a combination of both.

Note.— See Appendix 5 for the CPDLC message set including message intent/use and the respective message elements.

14.3.1.1 The use of long messages or messages with multiple clearance elements, multiple clearance request elements or messages with a combination of clearances and information should be avoided where possible.

Note.— Guidance material on the development of local operating procedures and CPDLC good operating technique can be found in the Human Factors Guidelines for Air Traffic Management (ATM) Systems (Doc 9758).

14.3.1.2 When CPDLC is being used, and the intent of the message is included in the CPDLC message set contained in Appendix 5, the associated standard message elements shall be used.

14.3.1.3 Except as provided by 14.3.5.1, when a controller or pilot communicates via CPDLC, the response should be via CPDLC. When a controller or pilot communicates via voice, the response should be via voice.

14.3.1.4 Whenever a correction to a message sent via CPDLC is deemed necessary or the contents of a message need to be clarified, the controller or pilot shall use the most appropriate means available for issuing the correct details or for providing clarification.

Note.— The following procedures may be applied by the controller, in terms of correcting clearances, instructions or information, or by a pilot, in terms of correcting a reply to an uplink message or correcting previously advised requests or information.

14.3.1.4.1 When voice communications are used to correct a CPDLC message for which no operational response has yet been received, the controller's or pilot's transmission shall be prefaced by the phrase: "DISREGARD CPDLC (message type) MESSAGE, BREAK" — followed by the correct clearance, instruction, information or request.

Note.— It is possible that, at the time the voice-communicated clarification is transmitted, the CPDLC message being referred to has not yet reached the recipient, or has reached the recipient but not acted upon, or has reached the recipient and acted upon.

14.3.1.4.2 When referring to and identifying the CPDLC message to be disregarded, caution should be exercised in its phrasing so as to avoid any ambiguity with the issuance of the accompanying corrected clearance, instruction, information or request.

Note.— For example, if SAS 445, maintaining FL 290, had been instructed via CPDLC to climb to FL 350, and the controller needs to correct the clearance utilizing voice communications, the following phrase might be used:

SAS445 DISREGARD CPDLC CLIMB CLEARANCE MESSAGE, BREAK, CLIMB TO FL310.

14.3.1.4.3 If a CPDLC message that requires an operational response is subsequently negotiated via voice, an appropriate CPDLC message closure response shall be sent, to ensure proper synchronization of the CPDLC dialogue. This could be achieved either by explicitly instructing the recipient of the message via voice to close the dialogue or by allowing the system to automatically close the dialogue.

14.3.2 Message attributes dictate certain message handling requirements for the CPDLC user receiving a message. Each CPDLC message has two attributes: Alert and Response.

14.3.2.1 ALERT

The alert attribute delineates the type of alerting required upon message receipt. Alert types are presented in Table 14-1.

14.3.2.2 RESPONSE

14.3.2.2.1 The response attribute delineates valid responses for a given message element. Response types are presented in Table 14-2 for uplink messages and Table 14-3 for downlink messages.

14.3.2.2.2 When a multi-element message requires a response, the response shall apply to all message elements.

Note.— For example, given a multi-element message containing CLIMB TO FL 310 MAINTAIN MACH .84, a WILCO response applies to, and indicates compliance with, both elements of the message.

14.3.2.2.3 When a single message element clearance or any part of a multi-element clearance message cannot be complied with, the pilot shall send an UNABLE response for the whole message.

14.3.2.2.4 The controller shall respond with an UNABLE message that applies to all elements of the request when no element(s) of a single or multi-element clearance request can be approved. The current clearance(s) shall not be restated.

Table 14-1. Alert attribute (uplink and downlink)

<i>Type</i>	<i>Description</i>	<i>Precedence</i>
H	High	1
M	Medium	2
L	Low	3
N	No alerting required	4

14.3.2.2.5 When a multi-element clearance request can only be partially accommodated, the controller shall respond with an UNABLE message applying to all the message elements of the request and, if appropriate, include a reason and/or information on when a clearance may be expected.

Note.— A separate CPDLC message (or messages) may subsequently be transmitted to respond to those elements that can be accommodated.

14.3.2.2.6 When all elements of a single or multi-element clearance request can be accommodated, the controller shall respond with clearances corresponding to each element of the request. This response should be a single uplink message.

Note.— For example, while messages containing multi-element clearance requests are to be avoided, a multi-element downlink message containing the indicated message elements:

REQUEST CLEARANCE YQM YYG YYT YQX TRACK X EINN EDDF
 REQUEST CLIMB TO FL350
 REQUEST MACH 0.84

could be responded to with

CLEARED YQM YYG YYT YQX TRACK X EINN EDDF
 CLIMB TO FL350
 REPORT MAINTAINING
 CROSS YYG AT OR AFTER 1150
 NO SPEED RESTRICTION.

Table 14-2. Response attribute (uplink)

<i>Type</i>	<i>Response required</i>	<i>Valid responses</i>	<i>Precedence</i>
W/U	Yes	WILCO, UNABLE, STANDBY, NOT CURRENT DATA AUTHORITY, NOT AUTHORIZED NEXT DATA AUTHORITY, LOGICAL ACKNOWLEDGEMENT (only if required), ERROR	1
A/N	Yes	AFFIRM, NEGATIVE, STANDBY, NOT CURRENT DATA AUTHORITY, NOT AUTHORIZED NEXT DATA AUTHORITY, LOGICAL ACKNOWLEDGEMENT (only if required), ERROR	2
R	Yes	ROGER, UNABLE, STANDBY, NOT CURRENT DATA AUTHORITY, NOT AUTHORIZED NEXT DATA AUTHORITY, LOGICAL ACKNOWLEDGEMENT (only if required), ERROR	3
Y	Yes	Any CPDLC downlink message, LOGICAL ACKNOWLEDGEMENT (only if required)	4
N	No, unless logical acknowledgement required	LOGICAL ACKNOWLEDGEMENT (only if required), NOT CURRENT DATA AUTHORITY, NOT AUTHORIZED NEXT DATA AUTHORITY, ERROR	5

Table 14-3. Response attribute (downlink)

<i>Type</i>	<i>Response required</i>	<i>Valid responses</i>	<i>Precedence</i>
Y	Yes	Any CPDLC uplink message, LOGICAL ACKNOWLEDGEMENT (only if required)	1
N	No, unless logical acknowledgement required	LOGICAL ACKNOWLEDGEMENT (only if required), MESSAGE NOT SUPPORTED BY THIS ATC UNIT ERROR	2

14.3.2.2.7 When a CPDLC message contains more than one message element and the response attribute for the message is Y, when utilized, the single response message shall contain the corresponding number of replies and in the same order.

Note.— For example, a multi-element uplink message containing

CONFIRM SQUAWK
WHEN CAN YOU ACCEPT FL410

could be responded to with

SQUAWKING 5525
WE CAN ACCEPT FL410 AT 1636Z.

14.3.3 Transfer of CPDLC

14.3.3.1 When CPDLC is transferred, the transfer of voice communications and CPDLC shall commence concurrently.

14.3.3.2 When an aircraft is transferred from an ATC unit where CPDLC is available to an ATC unit where CPDLC is not available, CPDLC termination shall commence concurrent with the transfer of voice communications.

14.3.3.3 When a transfer of CPDLC results in a change of data authority, and there are still messages for which the closure response has not been received (i.e. messages outstanding), the controller transferring the CPDLC shall be informed.

14.3.3.3.1 If the controller needs to transfer the aircraft without replying to any downlink message(s) outstanding, the system shall have the capability to automatically send the appropriate closure response message(s). In such cases, the contents of any automatically sent closure response message(s) shall be promulgated in local instructions.

14.3.3.3.2 When the controller decides to transfer the aircraft without receiving pilot responses to any uplink message(s) outstanding, the controller should revert to voice communications to clarify any ambiguity associated with the message(s) outstanding.

14.3.4 Free text messages elements

Note.— Provisions concerning the use of free text message elements are contained in Annex 10, Volume II, Chapter 8.

14.3.4.1 The use of free text message elements by controllers or pilots should be avoided.

Note.— While it is recognized that non-routine and emergency situations may necessitate use of free text, particularly when voice communications have failed, the avoidance of utilizing free text messages is intended to reduce the possibility of misinterpretation and ambiguity.

14.3.4.2 When determined acceptable by the appropriate ATS authority to use free text message elements, free text message elements should be stored for selection within the aircraft system or ground system to facilitate their use.

14.3.5 Emergencies, hazards and equipment failure procedures

14.3.5.1 When a CPDLC emergency message is received, the controller shall acknowledge receipt of the message by the most efficient means available.

14.3.5.2 When responding via CPDLC to all other emergency or urgency messages, uplink message ROGER shall be used.

14.3.5.3 When a CPDLC message requires a logical acknowledgement and/or an operational response, and such a response is not received, the pilot or controller, as appropriate shall be alerted.

14.3.6 Failure of CPDLC

Note.— Action to be taken in the event of the failure of a single CPDLC message is covered in 14.3.8.

14.3.6.1 The controller and pilot shall be alerted to the failure of CPDLC as soon as the failure has been detected.

14.3.6.2 When a controller or pilot is alerted that CPDLC has failed, and the controller or pilot needs to communicate prior to CPDLC being restored, the controller or pilot should revert to voice, if possible, and preface the information with the phrase:

CPDLC FAILURE.

14.3.6.3 Controllers having a requirement to transmit information concerning a complete CPDLC ground system failure to all stations likely to intercept should preface such transmission by the general call ALL STATIONS CPDLC FAILURE, followed by the identification of the calling station.

Note.— No reply is expected to such general calls unless individual stations are subsequently called to acknowledge receipt.

14.3.6.4 When CPDLC fails and communications revert to voice, all CPDLC messages outstanding should be considered not delivered and the entire dialogue involving the messages outstanding should be recommenced by voice.

14.3.6.5 When CPDLC fails but is restored prior to a need to revert to voice communications, all messages outstanding should be considered not delivered and the entire dialogue involving the messages outstanding should be recommenced via CPDLC.

14.3.7 Intentional shutdown of CPDLC

14.3.7.1 When a system shutdown of the communications network or the CPDLC ground system is planned, a NOTAM shall be published to inform all affected parties of the shutdown period and, if necessary, the details of the voice communication frequencies to be used.

14.3.7.2 Aircraft currently in communication with the ATC unit shall be informed by voice or CPDLC of any imminent loss of CPDLC service.

14.3.7.3 The controller and pilot shall be provided with the capability to abort CPDLC.

14.3.8 Failure of a single CPDLC message

When a controller or pilot is alerted that a single CPDLC message has failed, the controller or pilot shall take one of the following actions as appropriate:

- a) via voice, confirm the actions that will be undertaken with respect to the related dialogue, prefacing the information with the phrase:

CPDLC MESSAGE FAILURE;

- b) via CPDLC, reissue the CPDLC message that failed.

14.3.9 Discontinuation of the use of CPDLC pilot requests

14.3.9.1 When a controller requires all stations or a specific flight to avoid sending CPDLC requests for a limited period of time, the following phrase shall be used:

((call sign) or ALL STATIONS) STOP SENDING CPDLC REQUESTS [UNTIL ADVISED] [(reason)]

Note.— Under these circumstances, CPDLC remains available for the pilot to respond, if necessary, to messages, to report information and, to declare and cancel an emergency.

14.3.9.2 The resumption of the normal use of CPDLC shall be advised using the following phrase:

((call sign) or ALL STATIONS) RESUME NORMAL CPDLC OPERATIONS

14.3.10 Testing of CPDLC

Where the testing of CPDLC with an aircraft could affect the air traffic services being provided to the aircraft, coordination shall be effected prior to such testing.

Chapter 15

PROCEDURES RELATED TO EMERGENCIES, COMMUNICATION FAILURE AND CONTINGENCIES

15.1 EMERGENCY PROCEDURES

15.1.1 General

15.1.1.1 The various circumstances surrounding each emergency situation preclude the establishment of exact detailed procedures to be followed. The procedures outlined herein are intended as a general guide to air traffic services personnel. Air traffic control units shall maintain full and complete coordination, and personnel shall use their best judgement in handling emergency situations.

Note 1.— Additional procedures to be applied in relation to emergencies and contingencies while using an ATS surveillance system are contained in Chapter 8, 8.8.1.

Note 2.— If the pilot of an aircraft encountering a state of emergency has previously been directed by ATC to select a specific transponder code and/or a specific ADS-B emergency mode, that code and/or mode will normally be maintained unless, in special circumstances, the pilot has decided or has been advised otherwise. Where ATC has not requested a code or emergency mode to be set, the pilot will set the transponder to Mode A Code 7700 and/or the appropriate ADS-B emergency mode.

Note 3.— Some aircraft equipped with first generation ADS-B avionics have the capability to transmit a general emergency alert only, regardless of the code selected by the pilot.

Note 4.— Some aircraft equipped with first generation ADS-B avionics do not have the capability of squawking IDENT while the emergency and/or urgency mode is selected.

15.1.1.2 When an emergency is declared by an aircraft, the ATS unit should take appropriate and relevant action as follows:

- a) unless clearly stated by the flight crew or otherwise known, take all necessary steps to ascertain aircraft identification and type, the type of emergency, the intentions of the flight crew as well as the position and level of the aircraft;
- b) decide upon the most appropriate type of assistance which can be rendered;
- c) enlist the aid of any other ATS unit or other services which may be able to provide assistance to the aircraft;
- d) provide the flight crew with any information requested as well as any additional relevant information, such as details on suitable aerodromes, minimum safe altitudes, weather information;
- e) obtain from the operator or the flight crew such of the following information as may be relevant: number of persons on board, amount of fuel remaining, possible presence of hazardous materials and the nature thereof; and
- f) notify the appropriate ATS units and authorities as specified in local instructions.

15.1.1.3 Changes of radio frequency and SSR code should be avoided if possible and should normally be made only when or if an improved service can be provided to the aircraft concerned. Manoeuvring instructions to an aircraft experiencing engine failure should be limited to a minimum. When appropriate, other aircraft operating in the vicinity of the aircraft in emergency should be advised of the circumstances.

Note.— Requests to the flight crew for the information contained in 15.1.1.2 e) will be made only if the information is not available from the operator or from other sources and will be limited to essential information.

15.1.2 Priority

An aircraft known or believed to be in a state of emergency, including being subjected to unlawful interference, shall be given priority over other aircraft.

15.1.3 Unlawful interference and aircraft bomb threat

15.1.3.1 Air traffic services personnel shall be prepared to recognize any indication of the occurrence of unlawful interference with an aircraft.

15.1.3.2 Whenever unlawful interference with an aircraft is suspected, and where automatic distinct display of SSR Mode A Code 7500 and Code 7700 is not provided, the controller shall attempt to verify any suspicion by setting the SSR decoder to Mode A Code 7500 and thereafter to Code 7700.

Note.— An aircraft equipped with an SSR transponder is expected to operate the transponder on Mode A Code 7500 to indicate specifically that it is the subject of unlawful interference. The aircraft may operate the transponder on Mode A Code 7700, to indicate that it is threatened by grave and imminent danger and requires immediate assistance. An aircraft equipped with other surveillance system transmitters, including ADS-B and ADS-C, might send the emergency and/or urgency signal by all of the available means.

15.1.3.3 Whenever unlawful interference with an aircraft is known or suspected or a bomb threat warning has been received, ATS units shall promptly attend to requests by, or to anticipated needs of, the aircraft, including requests for relevant information relating to air navigation facilities, procedures and services along the route of flight and at any aerodrome of intended landing, and shall take such action as is necessary to expedite the conduct of all phases of the flight.

15.1.3.3.1 ATS units shall also:

- a) transmit, and continue to transmit, information pertinent to the safe conduct of the flight, without expecting a reply from the aircraft;
- b) monitor and plot the progress of the flight with the means available, and coordinate transfer of control with adjacent ATS units without requiring transmissions or other responses from the aircraft, unless communication with the aircraft remains normal;
- c) inform, and continue to keep informed, appropriate ATS units, including those in adjacent FIRs, which may be concerned with the progress of the flight;

Note.— In applying this provision, account must be taken of all the factors which may affect the progress of the flight, including fuel endurance and the possibility of sudden changes in route and destination. The objective is to provide, as far in advance as is practicable in the circumstances, each ATS unit with appropriate information as to the expected or possible penetration of the aircraft into its area of responsibility.

- d) notify:

- 1) the operator or its designated representative;
- 2) the appropriate rescue coordination centre in accordance with appropriate alerting procedures;
- 3) the appropriate authority designated by the State;

Note.— It is assumed that the designated security authority and/or the operator will in turn notify other parties concerned in accordance with pre-established procedures.

- e) relay appropriate messages, relating to the circumstances associated with the unlawful interference, between the aircraft and designated authorities.

Note.— These messages include, but are not limited to: initial messages declaring an incident; update messages on an existing incident; messages containing decisions made by appropriate decision makers; messages on transfer of responsibility; messages on acceptance of responsibility; messages indicating that an entity is no longer involved in an incident; and messages closing an incident.

15.1.3.4 The following additional procedures shall apply if a threat is received indicating that a bomb or other explosive device has been placed on board a known aircraft. The ATS unit receiving the threat information shall:

- a) if in direct communication with the aircraft, advise the flight crew without delay of the threat and the circumstances surrounding the threat; or
- b) if not in direct communication with the aircraft, advise the flight crew by the most expeditious means through other ATS units or other channels.

15.1.3.5 The ATS unit in communication with the aircraft shall ascertain the intentions of the flight crew and report those intentions to other ATS units which may be concerned with the flight.

15.1.3.6 The aircraft shall be handled in the most expeditious manner while ensuring, to the extent possible, the safety of other aircraft and that personnel and ground installations are not put at risk.

15.1.3.7 Aircraft in flight shall be given re-clearance to a requested new destination without delay. Any request by the flight crew to climb or descend for the purpose of equalizing or reducing the differential between the outside air pressure and the cabin air pressure shall be approved as soon as possible.

15.1.3.8 An aircraft on the ground should be advised to remain as far away from other aircraft and installations as possible and, if appropriate, to vacate the runway. The aircraft should be instructed to taxi to a designated or isolated parking area in accordance with local instructions. Should the flight crew disembark passengers and crew immediately, other aircraft, vehicles and personnel should be kept at a safe distance from the threatened aircraft.

15.1.3.9 ATS units shall not provide any advice or suggestions concerning action to be taken by the flight crew in relation to an explosive device.

15.1.3.10 An aircraft known or believed to be the subject of unlawful interference or which for other reasons needs isolation from normal aerodrome activities shall be cleared to the designated isolated parking position. Where such an isolated parking position has not been designated, or if the designated position is not available, the aircraft shall be cleared to a position within the area or areas selected by prior agreement with the aerodrome authority. The taxi clearance shall specify the taxi route to be followed to the parking position. This route shall be selected with a view to minimizing any security risks to the public, other aircraft and installations at the aerodrome.

Note.— See Annex 14, Volume I, Chapter 3.

15.1.4 Emergency descent

15.1.4.1 ACTION BY THE ATS UNIT

Upon recognition that an aircraft is making an emergency descent, all appropriate action shall be taken immediately to safeguard all aircraft concerned. Appropriate actions may include the following, in the order appropriate for the circumstance:

- a) broadcasting an emergency message;
- b) issuing traffic information and/or instructions to aircraft affected by the descent;
- c) advising the minimum flight altitude and altimeter setting for the area of operation; and
- d) informing any other ATS units which may be affected by the emergency descent.

15.1.4.2 ACTION BY THE PILOT OF THE AIRCRAFT IN AN EMERGENCY DESCENT

The pilot shall take the following steps as soon as practicable in the order appropriate for the circumstance:

- a) navigate as deemed appropriate by the pilot;
- b) advise the appropriate ATS unit of the emergency descent and, if able, intentions;
- c) set transponder to Code 7700 and, if applicable, select the appropriate emergency mode on ADS-B and/or ADS-C;
- d) turn on aircraft exterior lights (commensurate with appropriate operating limitations);
- e) watch for conflicting traffic both visually and by reference to ACAS (if equipped); and
- f) when emergency descent is complete, coordinate further intentions with the appropriate ATS unit.

Note.— Procedures for the use of ACAS are contained in PANS-OPS, Volume I, Part III, Section 3, Chapter 3.

15.1.4.3 ACTION BY THE PILOT OF THE AIRCRAFT RECEIVING EMERGENCY DESCENT BROADCAST

Unless specifically instructed by the ATS unit to clear the area or threatened by immediate danger, the pilot shall take the following actions:

- a) continue according to current clearance and maintain listening watch on the frequency in use for any further instructions from the ATS unit; and
- b) watch for conflicting traffic both visually and by reference to ACAS (if equipped).

15.2 SPECIAL PROCEDURES FOR IN-FLIGHT CONTINGENCIES IN OCEANIC AIRSPACE

15.2.1 Introduction

15.2.1.1 Although all possible contingencies cannot be covered, the procedures in 15.2.2 and 15.2.3 provide for the more frequent cases such as:

- a) inability to comply with assigned clearance due to meteorological conditions, aircraft performance or pressurization failure;
- b) en-route diversion across the prevailing traffic flow; and
- c) loss of, or significant reduction in, the required navigation capability when operating in an airspace where the navigation performance accuracy is a prerequisite to the safe conduct of flight operations.

15.2.1.2 With regard to 15.2.1.1 a) and b), the procedures are applicable primarily when descent and/or turnback or diversion is required. The pilot shall take action as necessary to ensure the safety of the aircraft, and the pilot's judgement shall determine the sequence of actions to be taken, having regard to the prevailing circumstances. Air traffic control shall render all possible assistance.

15.2.2 General procedures

15.2.2.1 If an aircraft is unable to continue the flight in accordance with its ATC clearance, and/or an aircraft is unable to maintain the navigation performance accuracy specified for the airspace, a revised clearance shall be obtained, whenever possible, prior to initiating any action.

15.2.2.2 The radiotelephony distress signal (MAYDAY) or urgency signal (PAN PAN) preferably spoken three times shall be used as appropriate. Subsequent ATC action with respect to that aircraft shall be based on the intentions of the pilot and the overall air traffic situation.

15.2.2.3 If prior clearance cannot be obtained, until a revised clearance is received the following contingency procedures should be employed and the pilot shall advise air traffic control as soon as practicable, reminding them of the type of aircraft involved and the nature of the problem. In general terms, the aircraft should be flown at a flight level and on an offset track where other aircraft are least likely to be encountered. Specifically, the pilot shall:

- a) leave the assigned route or track by initially turning at least 45 degrees to the right or to the left, in order to acquire a same or opposite direction track offset 15 NM (28 km) from the assigned track centreline. When possible, the direction of the turn should be determined by the position of the aircraft relative to any organized route or track system. Other factors which may affect the direction of the turn are:
 - 1) the direction to an alternate airport;
 - 2) terrain clearance;
 - 3) any strategic lateral offset being flown; and
 - 4) the flight levels allocated on adjacent routes or tracks;

- b) having initiated the turn:
 - 1) if unable to maintain the assigned flight level, initially minimize the rate of descent to the extent that is operationally feasible (pilots should take into account the possibility that aircraft below on the same track may be flying a 1 or 2 NM strategic lateral offset procedure (SLOP)) and select a final altitude which differs from those normally used by 150 m (500 ft) if at or below FL 410, or by 300 m (1 000 ft) if above FL 410; or
 - 2) if able to maintain the assigned flight level, once the aircraft has deviated 19 km (10 NM) from the assigned track centreline, climb or descend to select a flight level which differs from those normally used by 150 m (500 ft), if at or below FL 410, or by 300 m (1 000 ft) if above FL 410;
- c) establish communications with and alert nearby aircraft by broadcasting, at suitable intervals on 121.5 MHz (or, as a backup, on the inter-pilot air-to-air frequency 123.45 MHz) and where appropriate on the frequency in use: aircraft identification, flight level, position (including the ATS route designator or the track code, as appropriate) and intentions;
- d) maintain a watch for conflicting traffic both visually and by reference to ACAS (if equipped);
- e) turn on all aircraft exterior lights (commensurate with appropriate operating limitations); and
- f) keep the SSR transponder on at all times.

15.2.2.3.1 When leaving the assigned track:

- a) if the intention is to acquire a same direction offset track, the pilot should consider limiting the turn to a 45 degree heading change, in order not to overshoot the offset contingency track; or
- b) if the intention is to acquire and maintain an opposite direction offset track, then:
 - 1) operational limitations on bank angles at cruising altitudes will normally result in overshooting the track to be acquired. In such cases a continuous turn should be extended beyond 180 degrees heading change, in order to re-intercept the offset contingency track as soon as operationally feasible; and
 - 2) furthermore, if executing such a turnback in a 56 km (30 NM) lateral separation route structure, extreme caution pertaining to opposite direction traffic on adjacent routes must be exercised and any climb or descent, as specified in 15.2.2.3 b) 2), should be completed preferably before approaching within 19 km (10 NM) of any adjacent ATS route.

15.2.2.4 EXTENDED RANGE OPERATIONS BY AEROPLANES WITH TWO-TURBINE POWER-UNITS (ETOPS)

If the contingency procedures are employed by a twin-engine aircraft as a result of an engine shutdown or failure of an ETOPS critical system, the pilot should advise ATC as soon as practicable of the situation, reminding ATC of the type of aircraft involved, and request expeditious handling.

15.2.3 Weather deviation procedures

15.2.3.1 GENERAL

Note.— The following procedures are intended for deviations around adverse meteorological conditions.

15.2.3.1.1 When the pilot initiates communications with ATC, a rapid response may be obtained by stating “WEATHER DEVIATION REQUIRED” to indicate that priority is desired on the frequency and for ATC response. When necessary, the pilot should initiate the communications using the urgency call “PAN PAN” (preferably spoken three times).

15.2.3.1.2 The pilot shall inform ATC when weather deviation is no longer required, or when a weather deviation has been completed and the aircraft has returned to its cleared route.

15.2.3.2 ACTIONS TO BE TAKEN WHEN CONTROLLER-PILOT COMMUNICATIONS ARE ESTABLISHED

15.2.3.2.1 The pilot should notify ATC and request clearance to deviate from track, advising, when possible, the extent of the deviation expected.

15.2.3.2.2 ATC should take one of the following actions:

- a) when appropriate separation can be applied, issue clearance to deviate from track; or
- b) if there is conflicting traffic and ATC is unable to establish appropriate separation, ATC shall:
 - 1) advise the pilot of inability to issue clearance for the requested deviation;
 - 2) advise the pilot of conflicting traffic; and
 - 3) request the pilot’s intentions.

15.2.3.2.3 The pilot should take the following actions:

- a) comply with the ATC clearance issued; or
- b) advise ATC of intentions and execute the procedures detailed in 15.2.3.3.

15.2.3.3 ACTIONS TO BE TAKEN IF A REVISED ATC CLEARANCE CANNOT BE OBTAINED

Note.— The provisions of this section apply to situations where a pilot needs to exercise the authority of a pilot-in-command under the provisions of Annex 2, 2.3.1.

If the aircraft is required to deviate from track to avoid adverse meteorological conditions and prior clearance cannot be obtained, an ATC clearance shall be obtained at the earliest possible time. Until an ATC clearance is received, the pilot shall take the following actions:

- a) if possible, deviate away from an organized track or route system;

- b) establish communications with and alert nearby aircraft by broadcasting, at suitable intervals: aircraft identification, flight level, position (including ATS route designator or the track code) and intentions, on the frequency in use and on 121.5 MHz (or, as a backup, on the inter-pilot air-to-air frequency 123.45 MHz);
- c) watch for conflicting traffic both visually and by reference to ACAS (if equipped);

Note.— If, as a result of actions taken under the provisions of 15.2.3.3.1 b) and c), the pilot determines that there is another aircraft at or near the same flight level with which a conflict may occur, then the pilot is expected to adjust the path of the aircraft, as necessary, to avoid conflict.

- d) turn on all aircraft exterior lights (commensurate with appropriate operating limitations);
- e) for deviations of less than 19 km (10 NM) remain at a level assigned by ATC;
- f) for deviations greater than 19 km (10 NM), when the aircraft is approximately 19 km (10 NM) from track, initiate a level change in accordance with Table 15-1;
- g) when returning to track, be at its assigned flight level when the aircraft is within approximately 19 km (10 NM) of the centre line; and
- h) if contact was not established prior to deviating, continue to attempt to contact ATC to obtain a clearance. If contact was established, continue to keep ATC advised of intentions and obtain essential traffic information.

Table 15-1

<i>Route centre line track</i>	<i>Deviations > 19 km (10 NM)</i>	<i>Level change</i>
EAST 000° – 179° magnetic	LEFT RIGHT	DESCEND 90 m (300 ft) CLIMB 90 m (300 ft)
WEST 180° – 359° magnetic	LEFT RIGHT	CLIMB 90 m (300 ft) DESCEND 90 m (300 ft)

15.3 AIR-GROUND COMMUNICATIONS FAILURE

Note 1.— Procedures to be applied in relation to an aircraft experiencing air-ground communication failure when providing ATS surveillance services are contained in Chapter 8, Section 8.8.3.

Note 2.— An aircraft equipped with an SSR transponder is expected to operate the transponder on Mode A Code 7600 to indicate that it has experienced air-ground communication failure. An aircraft equipped with other surveillance system transmitters, including ADS-B and ADS-C, might indicate the loss of air-ground communication by all of the available means.

Note 3.— Some aircraft equipped with first generation ADS-B avionics have the capability to transmit a general emergency alert only, regardless of the code selected by the pilot.

Note 4.— See also Chapter 6, 6.3.2.5, concerning departure clearances containing no geographical or time limit for a cleared level below the flight planned level and procedures to be applied in relation to an aircraft experiencing air-ground communication failure under such circumstances.

Note 5. — See also Chapter 5, 5.4.2.6.3.2, for additional requirements applying to communication failure during the application of the 50 NM longitudinal RNAV/RNP 10 separation minimum.

15.3.1 Action by air traffic control units when unable to maintain two-way communication with an aircraft operating in a control area or control zone shall be as outlined in the paragraphs which follow.

15.3.2 As soon as it is known that two-way communication has failed, action shall be taken to ascertain whether the aircraft is able to receive transmissions from the air traffic control unit by requesting it to execute a specified manoeuvre which can be observed by an ATS surveillance system or to transmit, if possible, a specified signal in order to indicate acknowledgement.

Note.— Some aircraft equipped with first generation ADS-B avionics do not have the capability of squawking IDENT while the emergency and/or urgency mode is selected.

15.3.3 If the aircraft fails to indicate that it is able to receive and acknowledge transmissions, separation shall be maintained between the aircraft having the communication failure and other aircraft, based on the assumption that the aircraft will:

- a) if in visual meteorological conditions:
 - 1) continue to fly in visual meteorological conditions;
 - 2) land at the nearest suitable aerodrome; and
 - 3) report its arrival by the most expeditious means to the appropriate air traffic control unit; or
- b) if in instrument meteorological conditions or when conditions are such that it does not appear likely that the pilot will complete the flight in accordance with a):
 - 1) unless otherwise prescribed on the basis of a regional air navigation agreement, in airspace where procedural separation is being applied, maintain the last assigned speed and level, or minimum flight altitude if higher, for a period of 20 minutes following the aircraft's failure to report its position over a compulsory reporting point and thereafter adjust level and speed in accordance with the filed flight plan; or
 - 2) in airspace where an ATS surveillance system is used in the provision of air traffic control, maintain the last assigned speed and level, or minimum flight altitude if higher, for a period of 7 minutes following:
 - i) the time the last assigned level or minimum flight altitude is reached; or
 - ii) the time the transponder is set to Code 7600 or the ADS-B transmitter is set to indicate the loss of air-ground communications; or
 - iii) the aircraft's failure to report its position over a compulsory reporting point;whichever is later and thereafter adjust level and speed in accordance with the filed flight plan;
 - 3) when being vectored or having been directed by ATC to proceed offset using RNAV without a specified limit, proceed in the most direct manner possible to rejoin the current flight plan route no later than the next significant point, taking into consideration the applicable minimum flight altitude;
 - 4) proceed according to the current flight plan route to the appropriate designated navigation aid or fix serving the destination aerodrome and, when required to ensure compliance with 5), hold over this aid or fix until commencement of descent;

- 5) commence descent from the navigation aid or fix specified in 4) at, or as close as possible to, the expected approach time last received and acknowledged; or, if no expected approach time has been received and acknowledged, at, or as close as possible to, the estimated time of arrival resulting from the current flight plan;
- 6) complete a normal instrument approach procedure as specified for the designated navigation aid or fix; and
- 7) land, if possible, within 30 minutes after the estimated time of arrival specified in 5) or the last acknowledged expected approach time, whichever is later.

Note 1.— Provisions related to minimum levels are contained in Annex 2, 5.1.2.

Note 2.— As evidenced by the meteorological conditions prescribed therein, 15.3.3 a) relates to all controlled flights, whereas 15.3.3 b) relates only to IFR flights.

Note 3.— See also 8.6.5.1 b) concerning the requirement for the flight crew to be informed of what a vector is to accomplish and the limit of the vector.

15.3.4 Action taken to ensure suitable separation shall cease to be based on the assumption stated in 15.3.3 when:

- a) it is determined that the aircraft is following a procedure differing from that in 15.3.3; or
- b) through the use of electronic or other aids, air traffic control units determine that action differing from that required by 15.3.3 may be taken without impairing safety; or
- c) positive information is received that the aircraft has landed.

15.3.5 As soon as it is known that two-way communication has failed, appropriate information describing the action taken by the air traffic control unit, or instructions justified by any emergency situation, shall be transmitted blind for the attention of the aircraft concerned, on the frequencies available on which the aircraft is believed to be listening, including the voice frequencies of available radio navigation or approach aids. Information shall also be given concerning:

- a) meteorological conditions favourable to a cloud-breaking procedure in areas where congested traffic may be avoided; and
- b) meteorological conditions at suitable aerodromes.

15.3.6 Pertinent information shall be given to other aircraft in the vicinity of the presumed position of the aircraft experiencing the failure.

15.3.7 As soon as it is known that an aircraft which is operating in its area of responsibility is experiencing an apparent radiocommunication failure, an air traffic services unit shall forward information concerning the radiocommunication failure to all air traffic services units concerned along the route of flight. The ACC in whose area the destination aerodrome is located shall take steps to obtain information on the alternate aerodrome(s) and other relevant information specified in the filed flight plan, if such information is not available.

15.3.8 If circumstances indicate that a controlled flight experiencing a communication failure might proceed to (one of) the alternate aerodrome(s) specified in the filed flight plan, the air traffic control unit(s) serving the alternate aerodrome(s) and any other air traffic control units that might be affected by a possible diversion shall be informed of the circumstances of the failure and requested to attempt to establish communication with the aircraft at a time when the aircraft could possibly be within communication range. This shall apply particularly when, by agreement with the operator or a designated representative, a clearance has been transmitted blind to the aircraft concerned to proceed to an alternate aerodrome, or when meteorological conditions at the aerodrome of intended landing are such that a diversion to an alternate is considered likely.

15.3.9 When an air traffic control unit receives information that an aircraft, after experiencing a communication failure has re-established communication or has landed, that unit shall inform the air traffic services unit in whose area the aircraft was operating at the time the failure occurred, and other air traffic services units concerned along the route of flight, giving necessary information for the continuation of control if the aircraft is continuing in flight.

15.3.10 If the aircraft has not reported within thirty minutes after:

- a) the estimated time of arrival furnished by the pilot;
- b) the estimated time of arrival calculated by the ACC; or
- c) the last acknowledged expected approach time,

whichever is latest, pertinent information concerning the aircraft shall be forwarded to aircraft operators, or their designated representatives, and pilots-in-command of any aircraft concerned and normal control resumed if they so desire. It is the responsibility of the aircraft operators, or their designated representatives, and pilots-in-command of aircraft to determine whether they will resume normal operations or take other action.

15.4 ASSISTANCE TO VFR FLIGHTS

15.4.1 Strayed VFR flights and VFR flights encountering adverse meteorological conditions

Note.— A strayed aircraft is an aircraft which has deviated significantly from its intended track or which reports that it is lost.

15.4.1.1 A VFR flight reporting that it is uncertain of its position or lost, or encountering adverse meteorological conditions, should be considered to be in a state of emergency and handled as such. The controller shall, under such circumstances, communicate in a clear, concise and calm manner and care shall be taken, at this stage, not to question any fault or negligence that the pilot may have committed in the preparation or conduct of the flight. Depending on the circumstances, the pilot should be requested to provide any of the following information considered pertinent so as to better provide assistance:

- a) aircraft flight conditions;
- b) position (if known) and level;
- c) airspeed and heading since last known position, if pertinent;
- d) pilot experience;
- e) navigation equipment carried and if any navigation aid signals are being received;
- f) SSR mode and code selected if relevant;
- g) ADS-B capability;
- h) departure and destination aerodromes;
- i) number of persons on board;
- j) endurance.

15.4.1.2 If communications with the aircraft are weak or distorted, it should be suggested that the aircraft climb to a higher level, provided meteorological conditions and other circumstances permit.

15.4.1.3 Navigation assistance to help the pilot determine the aircraft position may be provided by use of an ATS surveillance system, direction-finder, navigation aids or sighting by another aircraft. Care must be taken when providing navigation assistance to ensure that the aircraft does not enter cloud.

Note.— The possibility of a VFR flight becoming strayed as a result of encountering adverse meteorological conditions must be recognized.

15.4.1.4 The pilot should be provided with reports and information on suitable aerodromes in the vicinity where visual meteorological conditions exist.

15.4.1.5 If reporting difficulty in maintaining or unable to maintain VMC, the pilot should be informed of the minimum flight altitude of the area where the aircraft is, or is believed to be. If the aircraft is below that level, and the position of the aircraft has been established with a sufficient degree of probability, a track or heading, or a climb, may be suggested to bring the aircraft to a safe level.

15.4.1.6 Assistance to a VFR flight should only be provided using an ATS surveillance system upon the request or concurrence of the pilot. The type of service to be provided should be agreed with the pilot.

15.4.1.7 When providing such assistance in adverse meteorological conditions, the primary objective should be to bring the aircraft into VMC as soon as possible. Caution must be exercised to prevent the aircraft from entering cloud.

15.4.1.8 Should circumstances be such that IMC cannot be avoided by the pilot, the following guidelines may be followed:

- a) other traffic on the ATC frequency not able to provide any assistance may be instructed to change to another frequency to ensure uninterrupted communications with the aircraft; alternatively the aircraft being assisted may be instructed to change to another frequency;
- b) ensure, if possible, that any turns by the aircraft are carried out clear of cloud;
- c) instructions involving abrupt manoeuvres should be avoided; and
- d) instructions or suggestions to reduce speed of the aircraft or to lower the landing gear, should, if possible, be carried out clear of cloud.

15.5 OTHER IN-FLIGHT CONTINGENCIES

Note.— The texts of 15.5.1 and 15.5.2 are reproduced from Annex 11, Chapter 2, and have the status of Standards.

15.5.1 Strayed or unidentified aircraft

Note 1.— The terms “strayed aircraft” and “unidentified aircraft” in this paragraph have the following meanings:

*Strayed aircraft. An aircraft which has deviated significantly from its intended track or which reports that it is lost.
Unidentified aircraft. An aircraft which has been observed or reported to be operating in a given area but whose identity has not been established.*

Note 2.— An aircraft may be considered, at the same time, as a “strayed aircraft” by one unit and as an “unidentified aircraft” by another unit.

Note 3.— A strayed or unidentified aircraft may be suspected as being the subject of unlawful interference. See Annex 11, 2.25.1.

15.5.1.1 As soon as an air traffic services unit becomes aware of a strayed aircraft, it shall take all necessary steps as outlined in 15.5.1.1.1 and 15.5.1.1.2 to assist the aircraft and to safeguard its flight.

Note.— Navigational assistance by an air traffic services unit is particularly important if the unit becomes aware of an aircraft straying, or about to stray, into an area where there is a risk of interception or other hazard to its safety.

15.5.1.1.1 If the aircraft’s position is not known, the air traffic services unit shall:

- a) attempt to establish two-way communication with the aircraft, unless such communication already exists;
- b) use all available means to determine its position;
- c) inform other ATS units into whose area the aircraft may have strayed or may stray, taking into account all the factors which may have affected the navigation of the aircraft in the circumstances;
- d) inform, in accordance with locally agreed procedures, appropriate military units and provide them with pertinent flight plan and other data concerning the strayed aircraft;
- e) request from the units referred to in c) and d) and from other aircraft in flight every assistance in establishing communication with the aircraft and determining its position.

Note.— The requirements in d) and e) apply also to ATS units informed in accordance with c).

15.5.1.1.2 When the aircraft’s position is established, the air traffic services unit shall:

- a) advise the aircraft of its position and corrective action to be taken; and
- b) provide, as necessary, other ATS units and appropriate military units with relevant information concerning the strayed aircraft and any advice given to that aircraft.

15.5.1.2 As soon as an air traffic services unit becomes aware of an unidentified aircraft in its area, it shall endeavour to establish the identity of the aircraft whenever this is necessary for the provision of air traffic services or required by the appropriate military authorities in accordance with locally agreed procedures. To this end, the air traffic services unit shall take such of the following steps as are appropriate in the circumstances:

- a) attempt to establish two-way communication with the aircraft;
- b) inquire of other air traffic services units within the FIR about the flight and request their assistance in establishing two-way communication with the aircraft;
- c) inquire of air traffic services units serving the adjacent FIRs about the flight and request their assistance in establishing two-way communication with the aircraft;
- d) attempt to obtain information from other aircraft in the area.

15.5.1.2.1 The air traffic services unit shall, as necessary, inform the appropriate military unit as soon as the identity of the aircraft has been established.

Note.— Requirements for coordination between military authorities and air traffic services are specified in Annex 11, 2.18.

15.5.1.3 Should the ATS unit consider that a strayed or unidentified aircraft may be the subject of unlawful interference, the appropriate authority designated by the State shall immediately be informed, in accordance with locally agreed procedures.

15.5.2 Interception of civil aircraft

15.5.2.1 As soon as an air traffic services unit learns that an aircraft is being intercepted in its area of responsibility, it shall take such of the following steps as are appropriate in the circumstances:

- a) attempt to establish two-way communication with the intercepted aircraft via any means available, including the emergency frequency 121.5 MHz, unless such communication already exists;
- b) inform the pilot of the intercepted aircraft of the interception;
- c) establish contact with the intercept control unit maintaining two-way communication with the intercepting aircraft and provide it with available information concerning the aircraft;
- d) relay messages between the intercepting aircraft or the intercept control unit and the intercepted aircraft, as necessary;
- e) in close coordination with the intercept control unit take all necessary steps to ensure the safety of the intercepted aircraft; and
- f) inform ATS units serving adjacent FIRs if it appears that the aircraft has strayed from such adjacent FIRs.

15.5.2.2 As soon as an air traffic services unit learns that an aircraft is being intercepted outside its area of responsibility, it shall take such of the following steps as are appropriate in the circumstances:

- a) inform the ATS unit serving the airspace in which the interception is taking place, providing this unit with available information that will assist in identifying the aircraft and requesting it to take action in accordance with 15.5.2.1;
- b) relay messages between the intercepted aircraft and the appropriate ATS unit, the intercept control unit or the intercepting aircraft.

15.5.3 Fuel dumping

15.5.3.1 GENERAL

15.5.3.1.1 An aircraft in an emergency or other urgent situations may need to dump fuel so as to reduce to maximum landing mass in order to effect a safe landing.

15.5.3.1.2 When an aircraft operating within controlled airspace needs to dump fuel, the flight crew shall advise ATC. The ATC unit should then coordinate with the flight crew the following:

- a) the route to be flown, which, if possible, should be clear of cities and towns, preferably over water and away from areas where thunderstorms have been reported or are expected;
- b) the level to be used, which should be not less than 1 800 m (6 000 ft); and
- c) the duration of the fuel dumping.

15.5.3.2 SEPARATION

Other known traffic should be separated from the aircraft dumping fuel by:

- a) at least 19 km (10 NM) horizontally, but not behind the aircraft dumping fuel;
- b) vertical separation if behind the aircraft dumping fuel within 15 minutes flying time or a distance of 93 km (50 NM) by:
 - 1) at least 300 m (1 000 ft) if above the aircraft dumping fuel; and
 - 2) at least 900 m (3 000 ft) if below the aircraft dumping fuel.

Note.— The horizontal boundaries of the area within which other traffic requires appropriate vertical separation extend for 19 km (10 NM) either side of the track flown by the aircraft which is dumping fuel, from 19 km (10 NM) ahead, to 93 km (50 NM) or 15 minutes along track behind it (including turns).

15.5.3.3 COMMUNICATIONS

If the aircraft will maintain radio silence during the fuel dumping operation, the frequency to be monitored by the flight crew and the time when radio silence will terminate should be agreed.

15.5.3.4 INFORMATION TO OTHER ATS UNITS AND NON-CONTROLLED TRAFFIC

15.5.3.4.1 A warning message shall be broadcast on appropriate frequencies for non-controlled traffic to remain clear of the area concerned. Adjacent ATC units and control sectors should be informed of the fuel dumping taking place and requested to broadcast on applicable frequencies an appropriate warning message for other traffic to remain clear of the area concerned.

15.5.3.4.2 Upon completion of the fuel dumping, adjacent ATC units and control sectors should be advised that normal operations can be resumed.

15.5.4 Fuel emergency and minimum fuel

Note 1.— General procedures to be applied when a pilot reports an emergency situation are contained in 15.1.1 and 15.1.2.

Note 2.— Coordination procedures to be applied between transferring and accepting ATS units for flights in fuel emergency or minimum fuel situations are contained in Chapter 10, 10.2.5.

Note 3.— The words MAYDAY FUEL describe the nature of the distress condition as required in Annex 10, Volume II, 5.3.2.1.1 b) 3.

15.5.4.1 When a pilot reports a state of minimum fuel, the controller shall inform the pilot as soon as practicable of any anticipated delays or that no delays are expected.

Note.— The declaration of MINIMUM FUEL informs ATC that all planned aerodrome options have been reduced to a specific aerodrome of intended landing, and any change to the existing clearance may result in landing with less than planned final reserve fuel. This is not an emergency situation but an indication that an emergency situation is possible should any additional delay occur.

15.5.5 Descents by supersonic aircraft due to solar cosmic radiation

Air traffic control units should be prepared for the possibility that supersonic aircraft operating at levels above 15 000 m (49 000 ft) may, on rare occasions, experience a rise in solar cosmic radiation which requires them to descend to lower levels, possibly down to or below the levels being used by subsonic aircraft. When such a situation is known or suspected, air traffic control units should take all possible action to safeguard all aircraft concerned, including any subsonic aircraft affected by the descent.

Note.— All supersonic aircraft in a particular portion of airspace will be affected at the same time, and the event may be accompanied by a deterioration or loss of air-ground communications. It is expected that the aircraft will alert air traffic control units before the radiation reaches a critical level and will request a descent clearance when the critical level is reached. However, situations may occur in which the aircraft will need to descend without waiting for a clearance. In such cases, the aircraft are expected to advise air traffic control units, as soon as possible, of the emergency action taken.

15.6 ATC CONTINGENCIES

The various circumstances surrounding each contingency situation preclude the establishment of exact detailed procedures to be followed. The procedures outlined below are intended as a general guide to air traffic services personnel.

15.6.1 Radiocommunications contingencies

15.6.1.1 GENERAL

ATC contingencies related to communications, i.e. circumstances preventing a controller from communicating with aircraft under control, may be caused by either a failure of ground radio equipment, a failure of airborne equipment, or by the control frequency being inadvertently blocked by an aircraft transmitter. The duration of such events may be for prolonged periods and appropriate action to ensure that the safety of aircraft is not affected should therefore be taken immediately.

15.6.1.2 GROUND RADIO FAILURE

15.6.1.2.1 In the event of complete failure of the ground radio equipment used for ATC, the controller shall:

- a) where aircraft are required to keep a listening watch on the emergency frequency 121.5 MHz, attempt to establish radiocommunications on that frequency;
- b) without delay inform all adjacent control positions or ATC units, as applicable, of the failure;
- c) appraise such positions or units of the current traffic situation;
- d) if practicable, request their assistance, in respect of aircraft which may establish communications with those positions or units, in establishing separation between and maintaining control of such aircraft; and
- e) instruct adjacent control positions or ATC units to hold or re-route all controlled flights outside the area of responsibility of the position or ATC unit that has experienced the failure until such time that the provision of normal services can be resumed.

15.6.1.2.2 In order to reduce the impact of complete ground radio equipment failure on the safety of air traffic, the appropriate ATS authority should establish contingency procedures to be followed by control positions and ATC units in the event of such failures. Where feasible and practicable, such contingency procedures should provide for the delegation of control to an adjacent control position or ATC unit in order to permit a minimum level of services to be provided as soon as possible, following the ground radio failure and until normal operations can be resumed.

15.6.1.3 BLOCKED FREQUENCY

In the event that the control frequency is inadvertently blocked by an aircraft transmitter, the following additional steps should be taken:

- a) attempt to identify the aircraft concerned;
- b) if the aircraft blocking the frequency is identified, attempts should be made to establish communication with that aircraft, e.g. on the emergency frequency 121.5 MHz, by SELCAL, through the aircraft operator's company frequency if applicable, on any VHF frequency designated for air-to-air use by flight crews or any other communication means or, if the aircraft is on the ground, by direct contact;
- c) if communication is established with the aircraft concerned, the flight crew shall be instructed to take immediate action to stop inadvertent transmissions on the affected control frequency.

15.6.1.4 UNAUTHORIZED USE OF ATC FREQUENCY

15.6.1.4.1 Instances of false and deceptive transmissions on ATC frequencies which may impair the safety of aircraft can occasionally occur. In the event of such occurrences, the ATC unit concerned should:

- a) correct any false or deceptive instructions or clearances which have been transmitted;
- b) advise all aircraft on the affected frequency(ies) that false and deceptive instructions or clearances are being transmitted;
- c) instruct all aircraft on the affected frequency(ies) to verify instructions and clearances before taking action to comply;

- d) if practical, instruct aircraft to change to another frequency; and
- e) if possible, advise all aircraft affected when the false and deceptive instructions or clearances are no longer being transmitted.

15.6.1.4.2 Flight crews shall challenge or verify with the ATC unit concerned any instruction or clearance issued to them which they suspect may be false or deceptive.

15.6.1.4.3 When the transmission of false or deceptive instructions and clearances is detected, the appropriate authority shall take all necessary action to have the transmitter located and the transmission terminated.

15.7 OTHER ATC CONTINGENCY PROCEDURES

15.7.1 Emergency separation

15.7.1.1 If, during an emergency situation, it is not possible to ensure that the applicable horizontal separation can be maintained, emergency separation of half the applicable vertical separation minimum may be used, i.e. 150 m (500 ft) between aircraft in airspace where a vertical separation minimum of 300 m (1 000 ft) is applied, and 300 m (1 000 ft) between aircraft in airspace where a 600 m (2 000 ft) vertical separation minimum is applied.

15.7.1.2 When emergency separation is applied the flight crews concerned shall be advised that emergency separation is being applied and informed of the actual minimum used. Additionally, all flight crews concerned shall be provided with essential traffic information.

15.7.2 Short-term conflict alert (STCA) procedures

Note 1.— The generation of short-term conflict alerts is a function based on surveillance data, integrated into an ATC system. The objective of the STCA function is to assist the controller in preventing collision between aircraft by generating, in a timely manner, an alert of a potential or actual infringement of separation minima.

Note 2.— In the STCA function the current and predicted three-dimensional positions of aircraft with pressure-altitude reporting capability are monitored for proximity. If the distance between the three-dimensional positions of two aircraft is predicted to be reduced to less than the defined applicable separation minima within a specified time period, an acoustic and/or visual alert will be generated to the controller within whose jurisdiction area the aircraft is operating.

15.7.2.1 Local instructions concerning use of the STCA function shall specify, inter alia:

- a) the types of flight which are eligible for generation of alerts;
- b) the sectors or areas of airspace within which the STCA function is implemented;
- c) the method of displaying the STCA to the controller;
- d) in general terms, the parameters for generation of alerts as well as alert warning time;
- e) the volumes of airspace within which STCA can be selectively inhibited and the conditions under which this will be permitted;
- f) conditions under which specific alerts may be inhibited for individual flights; and

- g) procedures applicable in respect of volume of airspace or flights for which STCA or specific alerts have been inhibited.

15.7.2.2 In the event an STCA is generated in respect of controlled flights, the controller shall without delay assess the situation and, if necessary, take action to ensure that the applicable separation minimum will not be infringed or will be restored.

15.7.2.3 Following the generation of an STCA, controllers should be required to complete an air traffic incident report only in the event that a separation minimum was infringed.

15.7.2.4 The appropriate ATS authority should retain electronic records of all alerts generated. The data and circumstances pertaining to each alert should be analysed to determine whether an alert was justified or not. Non-justified alerts, e.g. when visual separation was applied, should be ignored. A statistical analysis should be made of justified alerts in order to identify possible shortcomings in airspace design and ATC procedures as well as to monitor overall safety levels.

15.7.3 Procedures in regard to aircraft equipped with airborne collision avoidance systems (ACAS)

15.7.3.1 The procedures to be applied for the provision of air traffic services to aircraft equipped with ACAS shall be identical to those applicable to non-ACAS equipped aircraft. In particular, the prevention of collisions, the establishment of appropriate separation and the information which might be provided in relation to conflicting traffic and to possible avoiding action shall conform with the normal ATS procedures and shall exclude consideration of aircraft capabilities dependent on ACAS equipment.

15.7.3.2 When a pilot reports an ACAS resolution advisory (RA), the controller shall not attempt to modify the aircraft flight path until the pilot reports "Clear of Conflict".

15.7.3.3 Once an aircraft departs from its ATC clearance or instruction in compliance with an RA, or a pilot reports an RA, the controller ceases to be responsible for providing separation between that aircraft and any other aircraft affected as a direct consequence of the manoeuvre induced by the RA. The controller shall resume responsibility for providing separation for all the affected aircraft when:

- a) the controller acknowledges a report from the flight crew that the aircraft has resumed the current clearance; or
- b) the controller acknowledges a report from the flight crew that the aircraft is resuming the current clearance and issues an alternative clearance which is acknowledged by the flight crew.

Note.— Pilots are required to report RAs which require a deviation from the current ATC clearance or instruction (see PANS-OPS (Doc 8168), Volume I, Part III, Section 3, Chapter 3, 3.2 c) 4)). This report informs the controller that a deviation from clearance or instruction is taking place in response to an ACAS RA.

15.7.3.4 Guidance on training of air traffic controllers in the application of ACAS events is contained in the *Airborne Collision Avoidance System (ACAS) Manual (Doc 9863)*.

15.7.3.5 ACAS can have a significant effect on ATC. Therefore, the performance of ACAS in the ATC environment should be monitored.

15.7.3.6 Following a significant ACAS event, pilots and controllers should complete an air traffic incident report.

Note 1.— The ACAS capability of an aircraft may not be known to air traffic controllers.

Note 2.— Operating procedures for use of ACAS are contained in PANS-OPS (Doc 8168), Volume I, Part III, Section 3, Chapter 3.

Note 3.— The phraseology to be used by controllers and pilots is contained in Chapter 12, 12.3.1.2.

15.7.4 Minimum safe altitude warning (MSAW) procedures

Note 1.— The generation of minimum safe altitude warnings is a function of an ATC radar data-processing system. The objective of the MSAW function is to assist in the prevention of controlled flight into terrain accidents by generating, in a timely manner, a warning of the possible infringement of a minimum safe altitude.

Note 2.— In the MSAW function, the reported levels from aircraft with pressure-altitude reporting capability are monitored against defined minimum safe altitudes. When the level of an aircraft is detected or predicted to be less than the applicable minimum safe altitude, an acoustic and visual warning will be generated to the controller within whose jurisdiction area the aircraft is operating.

15.7.4.1 Local instructions concerning use of the MSAW function shall specify, *inter alia*:

- a) the types of flight which are eligible for generation of MSAW;
- b) the sectors or areas of airspace for which MSAW minimum safe altitudes have been defined and within which the MSAW function is implemented;
- c) the values of the defined MSAW minimum safe altitudes;
- d) the method of displaying the MSAW to the controller;
- e) the parameters for generation of MSAW as well as warning time; and
- f) conditions under which the MSAW function may be inhibited for individual aircraft tracks as well as procedures applicable in respect of flights for which MSAW has been inhibited.

15.7.4.2 In the event an MSAW is generated in respect of a controlled flight, the following action shall be taken without delay:

- a) if the aircraft is being vectored, the aircraft shall be instructed to climb immediately to the applicable safe level and, if necessary to avoid terrain, be assigned a new heading;
- b) in other cases, the flight crew shall immediately be advised that a minimum safe altitude warning has been generated and be instructed to check the level of the aircraft.

15.7.4.3 Following an MSAW event, controllers should complete an air traffic incident report only in the event that a minimum safe altitude was unintentionally infringed with a potential for controlled flight into terrain by the aircraft concerned.

15.7.5 Autonomous runway incursion warning system (ARIWS)

Note 1.— The generation of ARIWS warnings is a function based on surveillance data. The objective of the ARIWS function is to assist flight crews and vehicle drivers in the prevention of runway incursions by generating, in a timely manner, a direct warning of a possible runway hazard making it unsafe to enter, to cross a runway or to take-off

Note 2.— The function of ARIWS is to operate independently from ATC, and the warnings are generated for pilots and vehicle drivers.

Note 3.— Annex 14, Volume I, Attachment A, Section 21, provides a description of an autonomous runway incursion warning system (ARIWS) and information on its use.

15.7.5.1 In the event an ARIWS warning is generated that conflicts with the ATC clearance, the following action shall be taken by flight crew and vehicle drivers:

- a) the flight crew or vehicle driver shall give priority to the ARIWS warning over the ATC clearance. They shall not proceed onto the runway or commence the take-off roll. The flight crew or vehicle driver shall inform the controller of the ARIWS warning and await further clearance; and
- b) in the event the aircraft or vehicle has initiated actions to comply with a clearance that conflicts with the warning, the flight crew or the vehicle driver shall use the warning to exercise their best judgement and full authority in the choice of the best course of action to resolve any potential conflict. The controller should be informed, when practicable, of the ARIWS warning.

15.7.5.2 ATS units shall have procedures in place for situations when controllers are informed of ARIWS warnings, including how to disable the ARIWS in case of malfunctions.

15.7.6 Change of radiotelephony call sign for aircraft

15.7.6.1 An ATC unit may instruct an aircraft to change its type of RTF call sign, in the interests of safety, when similarity between two or more aircraft RTF call signs are such that confusion is likely to occur.

15.7.6.1.1 Any such change to the type of call sign shall be temporary and shall be applicable only within the airspace(s) where the confusion is likely to occur.

15.7.6.2 To avoid confusion, the ATC unit should, if appropriate, identify the aircraft which will be instructed to change its call sign by referring to its position and/or level.

15.7.6.3 When an ATC unit changes the type of call sign of an aircraft, that unit shall ensure that the aircraft reverts to the call sign indicated by the flight plan when the aircraft is transferred to another ATC unit, except when the call sign change has been coordinated between the two ATC units concerned.

15.7.6.4 The appropriate ATC unit shall advise the aircraft concerned when it is to revert to the call sign indicated by the flight plan.

15.8 PROCEDURES FOR ATS UNITS WHEN A VOLCANIC ASH CLOUD IS REPORTED OR FORECAST

15.8.1 If a volcanic ash cloud is reported or forecast in the airspace for which the ATS unit is responsible, the following actions should be taken:

- a) relay pertinent information immediately to flight crews whose aircraft could be affected to ensure that they are aware of the ash cloud's current and forecast position and the flight levels affected;
- b) accommodate requests for re-routing or level changes to the extent practicable;

- c) suggest re-routing to avoid or exit areas of reported or forecast ash clouds when requested by the pilot or deemed necessary by the controller; and
- d) when practicable, request a special air-report when the route of flight takes the aircraft into or near the forecast ash cloud and provide such special air-reports to the appropriate agencies.

Note 1.— Experience has shown that the recommended escape manoeuvre for an aircraft which has encountered an ash cloud is to reverse its course and begin a descent if terrain permits. The final responsibility for this decision, however, rests with the pilot-in-command as specified in the Manual on Volcanic Ash, Radioactive Material and Toxic Chemical Clouds (Doc 9691), 5.2.4.1.

Note 2.— The final authority as to the disposition of the aircraft, whether to avoid or proceed through a reported or forecast ash cloud, rests with the pilot-in-command, as prescribed in Annex 2, 2.4.

15.8.2 When the flight crew advises the ATS unit that the aircraft has inadvertently entered a volcanic ash cloud, the ATS unit should:

- a) take such action applicable to an aircraft in an emergency situation; and
- b) initiate modifications of route or level assigned only when requested by the pilot or necessitated by airspace requirements or traffic conditions.

Note 1.— General procedures to be applied when a pilot reports an emergency situation are contained in Chapter 15, 15.1.1 and 15.1.2.

Note 2.— Guidance material concerning the effect of volcanic ash and the impact of volcanic ash on aviation operational and support services is provided in Chapters 4 and 5 of Doc 9691.

Chapter 16

MISCELLANEOUS PROCEDURES

16.1 RESPONSIBILITY IN REGARD TO MILITARY TRAFFIC

16.1.1 It is recognized that some military aeronautical operations necessitate non-compliance with certain air traffic procedures. In order to ensure the safety of flight operations the appropriate military authorities shall be asked, whenever practicable, to notify the proper air traffic control unit prior to undertaking such manoeuvres.

16.1.2 A reduction of separation minima required by military necessity or other extraordinary circumstances shall only be accepted by an air traffic control unit when a specific request in some recorded form has been obtained from the authority having jurisdiction over the aircraft concerned and the lower minima then to be observed shall apply only between those aircraft. Some recorded form of instruction fully covering this reduction of separation minima must be issued by the air traffic control unit concerned.

16.1.3 Temporary airspace reservation, either stationary or mobile, may be established for the use of large formation flights or other military air operations. Arrangements for the reservation of such airspace shall be accomplished by coordination between the user and the appropriate ATS authority. The coordination shall be effected in accordance with the provisions of Annex 11 and completed early enough to permit timely promulgation of information in accordance with the provisions of Annex 15.

16.2 RESPONSIBILITY IN REGARD TO UNMANNED FREE BALLOONS

16.2.1 On receipt of notification of the intended flight of a medium or heavy unmanned free balloon, the air traffic services unit shall arrange for the information to be disseminated to all concerned. The information shall include:

- a) the balloon flight identification or project code name;
- b) balloon classification and description;
- c) SSR code or NDB frequency as applicable;
- d) the launch site;
- e) the estimated time of the commencement of the launch or the planned period of the launches;
- f) the expected direction of ascent;
- g) the cruising level(s) (pressure-altitude); and
- h) the estimated elapsed time to pass 18 000 m (60 000 ft) pressure-altitude, or to reach cruising level if at or below 18 000 m (60 000 ft), together with the estimated location.

16.2.2 On receipt of notification that a medium or heavy unmanned free balloon has been launched, the air traffic services unit shall arrange for the information to be disseminated to all concerned. The information shall include:

- a) the balloon flight identification or project code name;
- b) balloon classification and description;
- c) SSR code or NDB frequency as applicable;
- d) the launch site;
- e) the time of launch(es);
- f) the estimated time at which 18 000 m (60 000 ft) pressure-altitude will be passed, or the estimated time at which the cruising level will be reached if at or below 18 000 m (60 000 ft), and the estimated location;
- g) the estimated date and time of termination of the flight; and
- h) the planned location of ground contact, when applicable.

16.2.3 When there is reasonable expectation that a heavy or medium unmanned free balloon will cross international borders, the appropriate ATS unit shall arrange for the pre-launch and the launch notifications to be sent by NOTAM to the ATS unit(s) in the State(s) concerned. If agreed between the States concerned, the launch notification may be transmitted orally by direct ATS speech circuit between the ACCs/flight information centres involved.

16.2.4 Air traffic services units shall maintain radar and/or ADS-B surveillance of medium and heavy unmanned free balloons to the extent possible and, if necessary and on the request of the pilot of an aircraft, provide separation using an ATS surveillance system between the aircraft and such balloons which are identified or their exact position is known.

16.3 AIR TRAFFIC INCIDENT REPORT

16.3.1 An air traffic incident report shall be submitted, normally to the air traffic services unit concerned, for incidents specifically related to the provision of air traffic services involving such occurrences as aircraft proximity (AIRPROX), or other serious difficulty resulting in a hazard to aircraft, caused by, among others, faulty procedures, non-compliance with procedures, or failure of ground facilities.

16.3.2 Procedures should be established for the reporting of aircraft proximity incidents and their investigation to promote the safety of aircraft. The degree of risk involved in an aircraft proximity should be determined in the incident investigation and classified as “risk of collision”, “safety not assured”, “no risk of collision” or “risk not determined”.

16.3.3 When an accident/incident investigative authority conducts an investigation of an aircraft proximity incident, the air traffic services aspects should be included.

Note.— A model air traffic incident report form together with instructions for its completion is at Appendix 4. Further information regarding air traffic incidents is contained in the Air Traffic Services Planning Manual (Doc 9426).

16.4 USE OF REPETITIVE FLIGHT PLANS (RPLs)

16.4.1 General

16.4.1.1 RPLs shall not be used for flights other than IFR flights operated regularly on the same day(s) of consecutive weeks and on at least ten occasions or every day over a period of at least ten consecutive days. The elements of each flight plan shall have a high degree of stability.

Note.— For permissible incidental changes to RPL data affecting the operation for one particular day, and not intended to be a modification of the listed RPL, see 16.4.4.2.2 and 16.4.4.2.3.

16.4.1.2 RPLs shall cover the entire flight from the departure aerodrome to the destination aerodrome. RPL procedures shall be applied only when all ATS authorities concerned with the flights have agreed to accept RPLs.

16.4.1.3 The use by States of RPLs for international flight shall be subject to the provision that the affected adjacent States either already use RPLs or will use them at the same time. The procedures for use between States shall be the subject of bilateral, multilateral or regional air navigation agreement as appropriate.

16.4.2 Procedures for submission of RPLs by operators

16.4.2.1 Conditions governing submission, notification of changes, or cancellation of RPLs shall be the subject of appropriate arrangements between operators and the ATS authority concerned or of regional air navigation agreements.

16.4.2.2 An RPL shall comprise information regarding such of the following items as are considered relevant by the appropriate ATS authority:

- validity period of the flight plan
- days of operation
- aircraft identification
- aircraft type and wake turbulence category
- MLS capability
- departure aerodrome
- off-block time
- cruising speed(s)
- cruising level(s)
- route to be followed
- destination aerodrome
- total estimated elapsed time
- indication of the location where the following information may be obtained immediately upon request:
 - alternate aerodromes
 - fuel endurance
 - total number of persons on board
 - emergency equipment
- other information.

16.4.3 Submission of total listings

16.4.3.1 RPLs shall be submitted in the form of listings containing the required flight plan data using an RPL listing form specially designed for the purpose or by means of other media suitable for electronic data processing. The method of submission shall be determined by local or regional agreement.

Note.— A model RPL listing form is contained in Appendix 2.

16.4.3.2 Initial submission of complete RPL listings and any subsequent seasonal resubmission of complete listings shall be made in sufficient time to permit the data to be properly assimilated by the ATS organization. The minimum lead time required for the submission of such listings shall be established by the administrations concerned and published in their AIPs. This minimum lead time shall be at least two weeks.

16.4.3.3 Operators shall submit listings to the designated agency for distribution to the appropriate air traffic services units.

16.4.3.4 The information normally to be provided shall be that listed in 16.4.2.2 except that administrations may also require the provision of estimate information of FIR boundaries and the primary alternate aerodrome. If so required, such information shall be provided as indicated on an RPL listing form specially designed for the purpose.

16.4.3.5 Information regarding alternate aerodrome(s) and supplementary flight plan data (information normally provided under Item 19 of the ICAO flight plan form) shall be kept readily available by the operator at the departure aerodrome or another agreed location, so that, on request by ATS units, it can be supplied without delay. The name of the office from which the information can be obtained shall be recorded on the RPL listing form.

16.4.3.6 Acknowledgement of receipt of listings of flight plan data and/or amendment thereto shall not be required except by agreement between operators and the appropriate agency.

16.4.4 Changes to RPL listings

16.4.4.1 CHANGES OF A PERMANENT NATURE

16.4.4.1.1 Changes of a permanent nature involving the inclusion of new flights and the deletion or modification of currently listed flights shall be submitted in the form of amendment listings. These listings shall reach the air traffic services agency concerned at least seven days prior to the change becoming effective.

16.4.4.1.2 Where RPL listings have been initially submitted by the use of media suitable for electronic data processing, it shall be permissible by mutual agreement between the operator and the appropriate authority for some changes to be submitted by means of RPL listing forms.

16.4.4.1.3 All RPL changes shall be submitted in accordance with the instructions for preparation of RPL listings.

16.4.4.2 CHANGES OF A TEMPORARY NATURE

16.4.4.2.1 Changes of a temporary, non-recurring nature relating to RPLs concerning aircraft type and wake turbulence category, speed and/or cruising level shall be notified for each individual flight as early as possible and not later than 30 minutes before departure to the ATS reporting office responsible for the departure aerodrome. A change of cruising level only may be notified by radiotelephony on initial contact with the ATS unit.

16.4.4.2.2 In case of an incidental change in the aircraft identification, the departure aerodrome, the route and/or the destination aerodrome, the RPL shall be cancelled for the day concerned and an individual flight plan shall be submitted.

16.4.4.2.3 Whenever it is expected by the operator that a specific flight, for which an RPL has been submitted, is likely to encounter a delay of 30 minutes or more in excess of the off-block time stated in that flight plan, the ATS unit responsible for the departure aerodrome shall be notified immediately.

Note.— Because of the stringent requirements of flow control, failure by operators to comply with this procedure may result in the automatic cancellation of the RPL for that specific flight at one or more of the ATS units concerned.

16.4.4.2.4 Whenever it is known to the operator that any flight for which an RPL has been submitted is cancelled, the ATS unit responsible for the departure aerodrome shall be notified.

16.4.4.3 OPERATOR/PILOT LIAISON

The operator shall ensure that the latest flight plan information, including permanent and incidental changes, pertaining to a particular flight and duly notified to the appropriate agency, is made available to the pilot-in-command.

16.4.4.4 RPL PROCEDURES FOR ATS UNITS

The procedures for handling RPLs described herein are applicable regardless of whether automatic data-processing equipment is utilized or flight plan data is handled manually.

16.4.4.5 IMPLEMENTATION OF RPL PROCEDURES

16.4.4.5.1 Procedures for use of RPLs may be established for flights operating within a single FIR or a single State.

16.4.4.5.2 Procedures may also be established for flights across international boundaries subject to the provision that affected States currently utilize or will concurrently use RPLs.

16.4.4.5.3 Application of RPL procedures for international flights requires the establishment of bilateral or multilateral agreements between the States concerned. Multilateral agreements involving a number of States may take the form of regional air navigation agreements.

16.4.4.5.4 Application of RPLs requires agreements with participating operators to establish submission and amendment procedures.

16.4.4.5.5 Agreements shall include provisions for the following procedures:

- a) initial submission;
- b) permanent changes;
- c) temporary and incidental changes;
- d) cancellations;
- e) additions; and
- f) completely revised listings when indicated by extensive changes.

16.4.4.6 COLLECTION, STORAGE AND PROCESSING OF RPL DATA

16.4.4.6.1 Any State using RPLs shall designate one or more agencies responsible for administering such data. The area of responsibility for any such designated agency shall be at least one FIR. However, part or the entire area of responsibility of one or more States may be administered jointly by a designated agency. Each designated agency shall distribute relevant RPL data to the ATS units concerned within its area of responsibility so that such data reach these units in sufficient time to become effective.

16.4.4.6.2 RPLs shall be stored by each ATS unit concerned in a manner that will ensure that they are systematically activated on the appropriate day of operation in the order of estimated times indicative of entry into the unit's area of responsibility. Activation shall be accomplished in sufficient time to present the data to the controller in appropriate form for analysis and control action.

16.4.4.7 SUSPENSION OF RPL PROCEDURES

An appropriate ATS authority obliged, due to exceptional circumstances, to temporarily suspend the use of RPLs in its area of responsibility, or a specified part thereof, shall publish notice of such suspension with as much advance notice as possible and in the most suitable form considering the circumstances.

16.4.4.8 ATS MESSAGES RELATED TO INDIVIDUAL FLIGHTS OPERATING ON AN RPL

ATS messages relating to individual flights operating on an RPL shall be originated and addressed to ATS units concerned in a manner identical to that used for flights operating on individual flight plans.

16.5 STRATEGIC LATERAL OFFSET PROCEDURES (SLOP)

Note 1.— SLOP are approved procedures that allow aircraft to fly on a parallel track to the right of the centre line relative to the direction of flight to mitigate the lateral overlap probability due to increased navigation accuracy and wake turbulence encounters. Unless specified in the separation standard, an aircraft's use of these procedures does not affect the application of prescribed separation standards.

Note 2.— Annex 2, 3.6.2.1.1, requires authorization for the application of strategic lateral offsets from the appropriate ATS authority responsible for the airspace concerned.

16.5.1 Implementation of strategic lateral offset procedures shall be coordinated among the States involved.

Note.— Information concerning the implementation of strategic lateral offset procedures is contained in the Implementation of Strategic Lateral Offset Procedures (Circular 331).

16.5.2 Strategic lateral offsets shall be authorized only in en-route airspace as follows:

- a) where the lateral separation minima or spacing between route centre lines is 42.6 km (23 NM) or more, offsets to the right of the centre line relative to the direction of flight in tenths of a nautical mile up to a maximum of 3.7 km (2 NM); and
- b) where the lateral separation minima or spacing between route centre lines is 11.1 km (6 NM) or more and less than 42.6 km (23 NM), offsets to the right of the centre line relative to the direction of flight in tenths of a nautical mile up to a maximum of 0.9 km (0.5 NM).

16.5.3 The routes or airspace where application of strategic lateral offsets is authorized, and the procedures to be followed by pilots, shall be promulgated in aeronautical information publications (AIPs). In some instances, it may be necessary to impose restrictions on the use of strategic lateral offsets, e.g. where their application may be inappropriate for reasons related to obstacle clearance. Route conformance monitoring systems shall account for the application of SLOP.

16.5.4 The decision to apply a strategic lateral offset shall be the responsibility of the flight crew. The flight crew shall only apply strategic lateral offsets in airspace where such offsets have been authorized by the appropriate ATS authority and when the aircraft is equipped with automatic offset tracking capability.

Note 1.— Pilots may contact other aircraft on the inter-pilot air-to-air frequency 123.45 MHz to coordinate offsets.

Note 2.— The strategic lateral offset procedure has been designed to include offsets to mitigate the effects of wake turbulence of preceding aircraft. If wake turbulence needs to be avoided, an offset to the right and within the limits specified in 16.5.2 may be used.

Note 3.— Pilots are not required to inform ATC that a strategic lateral offset is being applied.

**16.6 NOTIFICATION OF SUSPECTED COMMUNICABLE DISEASES,
OR OTHER PUBLIC HEALTH RISK, ON BOARD AN AIRCRAFT**

16.6.1 The flight crew of an en-route aircraft shall, upon identifying a suspected case(s) of communicable disease, or other public health risk, on board the aircraft, promptly notify the ATS unit with which the pilot is communicating, the information listed below:

- a) aircraft identification;
- b) departure aerodrome;
- c) destination aerodrome;
- d) estimated time of arrival;
- e) number of persons on board;
- f) number of suspected case(s) on board; and
- g) nature of the public health risk, if known.

16.6.2 The ATS unit, upon receipt of information from a pilot regarding suspected case(s) of communicable disease, or other public health risk, on board the aircraft, shall forward a message as soon as possible to the ATS unit serving the destination/departure, unless procedures exist to notify the appropriate authority designated by the State and the aircraft operator or its designated representative.

16.6.3 When a report of a suspected case(s) of communicable disease, or other public health risk, on board an aircraft is received by an ATS unit serving the destination/departure, from another ATS unit or from an aircraft or an aircraft operator, the unit concerned shall forward a message as soon as possible to the public health authority (PHA) or the appropriate authority designated by the State as well as the aircraft operator or its designated representative, and the aerodrome authority.

Note 1.— See Annex 9 — Facilitation, Chapter 1 (Definitions), Chapter 8, 8.12 and 8.15, and Appendix 1, for relevant additional information related to the subject of communicable disease and public health risk on board an aircraft.

Note 2.— The PHA is expected to contact the airline representative or operating agency and aerodrome authority, if applicable, for subsequent coordination with the aircraft concerning clinical details and aerodrome preparation. Depending on the communications facilities available to the airline representative or operating agency, it may not be possible to communicate with the aircraft until it is closer to its destination. Apart from the initial notification to the ATS unit whilst en-route, ATC communications channels are to be avoided.

Note 3.— The information to be provided to the departure aerodrome will prevent the potential spread of communicable disease, or other public health risk, through other aircraft departing from the same aerodrome.

Note 4.— AFTN (urgency message), telephone, facsimile or other means of transmission may be used.

Appendix 1

INSTRUCTIONS FOR AIR-REPORTING BY VOICE COMMUNICATIONS

1. Reporting instructions
2. Special air-report of volcanic activity form (Model VAR)
3. Examples

1. Reporting instructions

MODEL AIREP SPECIAL

ITEM	PARAMETER	TRANSMIT IN TELEPHONY as appropriate
—	Message-type designator: • special air-report	[AIREP] SPECIAL

Section 1	1	Aircraft identification	<i>(aircraft identification)</i>
	2	Position	POSITION <i>(latitude and longitude)</i> OVER <i>(significant point)</i> ABEAM <i>(significant point)</i> <i>(significant point) (bearing) (distance)</i>
	3	Time	<i>(time)</i>
	4	Level	FLIGHT LEVEL <i>(number)</i> or <i>(number)</i> METRES or FEET CLIMBING TO FLIGHT LEVEL <i>(number)</i> or <i>(number)</i> METRES or FEET DESCENDING TO FLIGHT LEVEL <i>(number)</i> or <i>(number)</i> METRES or FEET
	5	Next position and estimated time over	<i>(position) (time)</i>
	6	Ensuing significant point	<i>(position)</i> NEXT
Section 2	7	Estimated time of arrival	<i>(aerodrome) (time)</i>
	8	Endurance	ENDURANCE <i>(hours and minutes)</i>
Section 3	9	Phenomenon encountered or observed, prompting a special air-report: <ul style="list-style-type: none"> • Moderate turbulence • Severe turbulence • Moderate icing • Severe icing • Severe mountainwave • Thunderstorms without hail • Thunderstorms with hail • Heavy dust/sandstorm • Volcanic ash cloud • Pre-eruption volcanic activity or volcanic eruption 	TURBULENCE MODERATE TURBULENCE SEVERE ICING MODERATE ICING SEVERE MOUNTAINWAVE SEVERE THUNDERSTORMS THUNDERSTORMS WITH HAIL DUSTSTORM or SANDSTORM HEAVY VOLCANIC ASH CLOUD PRE-ERUPTION VOLCANIC ACTIVITY or VOLCANIC ERUPTION

1. Position reports and special air-reports

1.1 Section 1 is obligatory for position reports and special air-reports, although Items 5 and 6 thereof may be omitted when prescribed in *Regional Supplementary Procedures*; Section 2 shall be added, in whole or in part, only when so requested by the operator or its designated representative, or when deemed necessary by the pilot-in-command; Section 3 shall be included in special air-reports.

1.2 Special air-reports shall be made whenever any of the phenomena listed under Item 15 are observed or encountered. Items 1 to 4 of Section 1 and the appropriate phenomenon specified in Section 3, Item 15, are required from all aircraft. The phenomena listed under "SST" shall be reported only by supersonic transport at transonic and supersonic cruising levels.

1.3 In the case of special air-reports containing information on volcanic activity, a post-flight report shall be made on the volcanic activity reporting form (Model VAR). All elements which are observed shall be recorded and indicated respectively in the appropriate places on the form Model VAR.

1.4 Special air-reports shall be made as soon as practicable after a phenomenon calling for a special air-report has been observed.

1.5 If a phenomenon warranting the making of a special air-report is observed at or near the time or place where a routine air-report is to be made, a special air-report shall be made instead.

2. Detailed reporting instructions

2.1 Items of an air-report shall be reported in the order in which they are listed in the model AIREP SPECIAL form.

— MESSAGE TYPE DESIGNATOR. Report "SPECIAL" for a special air-report.

Section 1

Item 1 — AIRCRAFT IDENTIFICATION. Report the aircraft radiotelephony call sign as prescribed in Annex 10, Volume II, Chapter 5.

Item 2 — POSITION. Report position in latitude (degrees as 2 numerics or degrees and minutes as 4 numerics, followed by "North" or "South") and longitude (degrees as 3 numerics or degrees and minutes as 5 numerics, followed by "East" or "West"), or as a significant point identified by a coded designator (2 to 5 characters), or as a significant point followed by magnetic bearing (3 numerics) and distance in nautical miles from the point (e.g. "4620North07805West", "4620North07800West", "4600North07800West", LN ("LIMA NOVEMBER"), "MAY", "HADDY" or "DUB 180 DEGREES 40 MILES"). Precede significant point by "ABEAM", if applicable.

Item 3 — TIME. Report time in hours and minutes UTC (4 numerics) unless reporting time in minutes past the hour (2 numerics) is prescribed on the basis of regional air navigation agreements. The time reported must be the actual time of the aircraft at the position and not the time of origination or transmission of the report. Time shall always be reported in hours and minutes UTC when making a special air-report.

Item 4 — FLIGHT LEVEL OR ALTITUDE. Report flight level by 3 numerics (e.g. "FLIGHT LEVEL 310"), when on standard pressure altimeter setting. Report altitude in metres followed by "METRES" or in feet followed by "FEET", when on QNH. Report "CLIMBING" (followed by the level) when climbing, or "DESCENDING" (followed by the level) when descending, to a new level after passing the significant point.

Item 5 — NEXT POSITION AND ESTIMATED TIME OVER. Report the next reporting point and the estimated time over such reporting point, or report the estimated position that will be reached one hour later, according to the position reporting procedures in force. Use the data conventions specified in Item 2 for position. Report the estimated time over this position. Report time in hours and minutes UTC (4 numerics) unless reporting time in minutes past the hour (2 numerics) as prescribed on the basis of regional air navigation agreements.

Item 6 — ENSUING SIGNIFICANT POINT. Report the ensuing significant point following the "next position and estimated time over".

Section 2

Item 7 — ESTIMATED TIME OF ARRIVAL. Report the name of the aerodrome of the first intended landing, followed by the estimated time of arrival at this aerodrome in hours and minutes UTC (4 numerics).

Item 8 — ENDURANCE. Report "ENDURANCE" followed by fuel endurance in hours and minutes (4 numerics).

Section 3

Item 9 — PHENOMENON PROMPTING A SPECIAL AIR-REPORT. Report one of the following phenomena encountered or observed:

- moderate turbulence as "TURBULENCE MODERATE"
severe turbulence as "TURBULENCE SEVERE"

The following specifications apply:

Moderate — Conditions in which moderate changes in aircraft attitude and/or altitude may occur but the aircraft remains in positive control at all times. Usually, small variations in airspeed. Changes in accelerometer readings of 0.5 g to 1.0 g at the aircraft's centre of gravity. Difficulty in walking. Occupants feel strain against seat belts. Loose objects move about.

Severe — Conditions in which abrupt changes in aircraft attitude and/or altitude occur; aircraft may be out of control for short periods. Usually, large variations in airspeed. Changes in accelerometer readings greater than 1.0 g at the aircraft's centre of gravity. Occupants are forced violently against seat belts. Loose objects are tossed about.

- moderate icing as "ICING MODERATE"
severe icing as "ICING SEVERE"

The following specifications apply:

Moderate — Conditions in which change of heading and/or altitude may be considered desirable.

Severe — Conditions in which immediate change of heading and/or altitude is considered essential.

- Severe mountainwave as "MOUNTAINWAVE SEVERE"

The following specification applies:

Severe — Conditions in which the accompanying downdraft is 3.0 m/s (600 ft/min) or more and/or severe turbulence is encountered.

- thunderstorm without hail as "THUNDERSTORM"
thunderstorm with hail as "THUNDERSTORM WITH HAIL"

The following specification applies:

Only report those thunderstorms which are:

- obscured in haze; or
- embedded in cloud; or
- widespread; or
- forming a squall-line.

- heavy duststorm or sandstorm as "DUSTSTORM or SANDSTORM HEAVY"
- volcanic ash cloud as "VOLCANIC ASH CLOUD"
- pre-eruption volcanic activity or a volcanic eruption as "PRE-ERUPTION VOLCANIC ACTIVITY or VOLCANIC ERUPTION"

The following specification applies:

Pre-eruption volcanic activity in this context means unusual and/or increasing volcanic activity which could presage a volcanic eruption.

Note. — In case of volcanic ash cloud, pre-eruption volcanic activity or volcanic eruption, in accordance with Chapter 4, 4.12.3, a post-flight report shall also be made on the special air-report of volcanic activity form (Model VAR).

2.2 Information recorded on the volcanic activity reporting form (Model VAR) is not for transmission by RTF but, on arrival at an aerodrome, is to be delivered without delay by the operator or a flight crew member to the aerodrome meteorological office. If such an office is not easily accessible, the completed form shall be delivered in accordance with local arrangements made between the meteorological and ATS authorities and the operator.

3. Forwarding of meteorological information received by voice communications

When receiving special air-reports, air traffic services units shall forward these air-reports without delay to the associated meteorological watch office (MWO). In order to ensure assimilation of air-reports in ground-based automated systems, the elements of such reports shall be transmitted using the data conventions specified below and in the order prescribed.

- ADDRESSEE. Record station called and, when necessary, relay required.
- MESSAGE TYPE DESIGNATOR. Record "ARS" for a special air-report.

Note. — Where air-reports are handled by automatic data processing equipment which cannot accept this message-type designator, in accordance with Chapter 11, 11.4.2.6.5.2, the use of a different message-type designator is permitted by regional air navigation agreement.

- AIRCRAFT IDENTIFICATION. Record the aircraft identification using the data convention specified for Item 7 of the flight plan, without a space between the operator's designator and the aircraft registration or flight identification, if used (e.g. New Zealand 103 as ANZ103).

Section 1

Item 0 — POSITION. Record position in latitude (degrees as 2 numerics or degrees and minutes as 4 numerics, followed without a space by N or S) and longitude (degrees as 3 numerics or degrees and minutes as 5 numerics, followed without a space by E or W), or as a significant point identified by a coded designator (2 to 5 characters), or as a significant point followed by magnetic bearing (3 numerics) and distance in nautical miles (3 numerics) from the point (e.g. 4620N07805W, 4620N078W, 46N078W, LN, MAY, HADDY or DUB180040). Precede significant point by "ABM" (abeam), if applicable.

Item 1 — TIME. Record time in hours and minutes UTC (4 numerics).

Item 2 — FLIGHT LEVEL OR ALTITUDE. Record F followed by 3 numerics (e.g. F310), when a flight level is reported. Record altitude in metres followed by M or in feet followed by FT, when an altitude is reported. Record "ASC" (level) when climbing, or "DES" (level) when descending.

Section 3

Item 9 — PHENOMENON PROMPTING A SPECIAL AIR-REPORT. Record the phenomenon reported as follows:

- moderate turbulence as "TURB MOD"
 - severe turbulence as "TURB SEV"
 - moderate icing as "ICE MOD"
 - severe icing as "ICE SEV"
 - severe mountainwave as "MTW SEV"
 - thunderstorm without hail as "TS"
 - thunderstorm with hail as "TSGR"
 - heavy duststorm or sandstorm as "HVY SS"
 - volcanic ash cloud as "VA CLD"
 - pre-eruption volcanic activity or a volcanic eruption as "VA"
 - hail as "GR"
 - cumulonimbus clouds as "CB".
- TIME TRANSMITTED. Record only when Section 3 is transmitted.

2. Special air-report of volcanic activity form (Model VAR)

MODEL VAR: to be used for post-flight reporting

VOLCANIC ACTIVITY REPORT

Air-reports are critically important in assessing the hazards which volcanic ash cloud presents to aircraft operations.

OPERATOR:			A/C IDENTIFICATION: (as indicated on flight plan)			
PILOT-IN-COMMAND:						
DEP FROM:	DATE:	TIME; UTC:	ARR AT:	DATE:	TIME; UTC:	
ADDRESSEE			AIREP SPECIAL			
Items 1-8 are to be reported immediately to the ATS unit that you are in contact with.						
1) AIRCRAFT IDENTIFICATION			2) POSITION			
3) TIME			4) FLIGHT LEVEL OR ALTITUDE			
5) VOLCANIC ACTIVITY OBSERVED AT (position or bearing, estimated level of ash cloud and distance from aircraft)						
6) AIR TEMPERATURE			7) SPOT WIND			
8) SUPPLEMENTARY INFORMATION			Other _____			
SO ₂ detected Yes <input type="checkbox"/> No <input type="checkbox"/>						
Ash encountered Yes <input type="checkbox"/> No <input type="checkbox"/>			(Brief description of activity especially vertical and lateral extent of ash cloud and, where possible, horizontal movement, rate of growth, etc.)			
After landing complete items 9-16 then fax form to: (Fax number to be provided by the meteorological authority based on local arrangements between the meteorological authority and the operator concerned.)						
9) DENSITY OF ASH CLOUD	<input type="checkbox"/>	(a) Wispy	<input type="checkbox"/>	(b) Moderate dense	<input type="checkbox"/>	(c) Very dense
10) COLOUR OF ASH CLOUD	<input type="checkbox"/>	(a) White	<input type="checkbox"/>	(b) Light grey	<input type="checkbox"/>	(c) Dark grey
	<input type="checkbox"/>	(d) Black	<input type="checkbox"/>	(e) Other _____		
11) ERUPTION	<input type="checkbox"/>	(a) Continuous	<input type="checkbox"/>	(b) Intermittent	<input type="checkbox"/>	(c) Not visible
12) POSITION OF ACTIVITY	<input type="checkbox"/>	(a) Summit	<input type="checkbox"/>	(b) Side	<input type="checkbox"/>	(c) Single
	<input type="checkbox"/>	(d) Multiple	<input type="checkbox"/>	(e) Not observed		
13) OTHER OBSERVED FEATURES OF ERUPTION	<input type="checkbox"/>	(a) Lightning	<input type="checkbox"/>	(b) Glow	<input type="checkbox"/>	(c) Large rocks
	<input type="checkbox"/>	(d) Ash fallout	<input type="checkbox"/>	(e) Mushroom cloud	<input type="checkbox"/>	(f) All
14) EFFECT ON AIRCRAFT	<input type="checkbox"/>	(a) Communication	<input type="checkbox"/>	(b) Navigation systems	<input type="checkbox"/>	(c) Engines
	<input type="checkbox"/>	(d) Pitot static	<input type="checkbox"/>	(e) Windscreen	<input type="checkbox"/>	(f) Windows
15) OTHER EFFECTS	<input type="checkbox"/>	(a) Turbulence	<input type="checkbox"/>	(b) St. Elmo's Fire	<input type="checkbox"/>	(c) Other fumes
16) OTHER INFORMATION (Any information considered useful.)						

3. Examples

AS SPOKEN IN RADIOTELEPHONY

AS RECORDED BY THE AIR TRAFFIC SERVICES UNIT AND FORWARDED TO THE METEOROLOGICAL OFFICE CONCERNED

I.¹ AIREP SPECIAL CLIPPER WUN ZERO WUN POSITION FIFE ZERO FOWer FIFE NORTH ZERO TOO ZERO WUN FIFE WEST WUN FIFE TREE SIX FLIGHT LEVEL TREE WUN ZERO CLIMBING TO FLIGHT LEVEL TREE FIFE ZERO THUNDERSTORMS WITH HAIL

I.- ARS PAA101 5045N02015W 1536 F310 ASC F350 TSGR

II.² SPECIAL NIUGINI TOO SEVen TREE OVER MADANG ZERO AIT FOWer SIX WUN NINer TOUSAND FEET TURBULENCE SEVERE

II.- ARS ANG273 MD 0846 19000FT TURB SEV

1. A special air-report which is required because of the occurrence of widespread thunderstorms with hail.

2. A special air-report which is required because of severe turbulence. The aircraft is on QNH altimeter setting.

Appendix 2

FLIGHT PLAN

1. ICAO model flight plan form
2. Instructions for the completion of the flight plan form
3. Instructions for the transmission of a filed flight plan (FPL) message
4. Instructions for the transmission of a supplementary flight plan (SPL) message
5. Example of a completed flight plan form
6. ICAO model repetitive flight plan (RPL) listing form
7. Instructions for the completion of the repetitive flight plan (RPL) listing form
8. Example of a completed repetitive flight plan (RPL) listing form

1. ICAO model flight plan form

FLIGHT PLAN PLAN DE VOL			
PRIORITY Priorité <<< FF >>>	ADDRESSEE(S) Destinataire(s)		
FILING TIME Heure de dépôt		ORIGINATOR Expéditeur	
SPECIFIC IDENTIFICATION OF ADDRESSEE(S) AND/OR ORIGINATOR Identification précise du(des) destinataire(s) et/ou de l'expéditeur			
3 MESSAGE TYPE Type de message <<< (FPL	7 AIRCRAFT IDENTIFICATION Identification de l'aéronef	8 FLIGHT RULES Règles de vol	TYPE OF FLIGHT Type de vol
9 NUMBER Nombre	TYPE OF AIRCRAFT Type d'aéronef	WAKE TURBULENCE CAT. Cat. de turbulence de sillage	10 EQUIPMENT Équipement
13 DEPARTURE AERODROME Aérodrome de départ		TIME Heure	
15 CRUISING SPEED Vitesse croisière	LEVEL Niveau	ROUTE Route	
16 DESTINATION AERODROME Aérodrome de destination		TOTAL EET Durée totale estimée HR MIN	ALTN AERODROME Aérodrome de dégagement
18 OTHER INFORMATION Renseignements divers		2ND ALTN AERODROME 2 ^e aérodrome de dégagement	
SUPPLEMENTARY INFORMATION (NOT TO BE TRANSMITTED IN FPL MESSAGES) Renseignements complémentaires (À NE PAS TRANSMETTRE DANS LES MESSAGES DE PLAN DE VOL DÉPOSÉ)			
19 ENDURANCE Autonomie E / HR MIN	PERSONS ON BOARD Personnes à bord P /	EMERGENCY RADIO Radio de secours R / UHF U V ELT	
SURVIVAL EQUIPMENT/Équipement de survie S / P		JACKETS/Gilets de sauvetage J / L	
DINGHIES/Canots D /	POLAR Polaire P	DESERT Désert D	MARITIME Maritime M
NUMBER Nombre D /	CAPACITY Capacité C /	COVER Couverture C /	COLOUR Couleur C /
AIRCRAFT COLOUR AND MARKINGS Couleur et marques de l'aéronef			
REMARKS Remarques A /			
PILOT-IN-COMMAND Pilote commandant de bord N /			
FILED BY / Déposé par C /			
		SPACE RESERVED FOR ADDITIONAL REQUIREMENTS Espace réservé à des fins supplémentaires	

2. Instructions for the completion of the flight plan form

2.1 General

Adhere closely to the prescribed formats and manner of specifying data.

Commence inserting data in the first space provided. Where excess space is available, leave unused spaces blank.

Insert all clock times in 4 figures UTC.

Insert all estimated elapsed times in 4 figures (hours and minutes).

Shaded area preceding Item 3 — to be completed by ATS and COM services, unless the responsibility for originating flight plan messages has been delegated.

Note.— The term “aerodrome” where used in the flight plan is intended to cover also sites other than aerodromes which may be used by certain types of aircraft, e.g. helicopters or balloons.

2.2 Instructions for insertion of ATS data

Complete Items 7 to 18 as indicated hereunder.

Complete also Item 19 as indicated hereunder, when so required by the appropriate ATS authority or when otherwise deemed necessary.

Note 1.— *Item numbers on the form are not consecutive, as they correspond to Field Type numbers in ATS messages.*

Note 2.— *Air traffic services data systems may impose communications or processing constraints on information in filed flight plans. Possible constraints may, for example, be limits with regard to item length, number of elements in the route item or total flight plan length. Significant constraints are documented in the relevant Aeronautical Information Publication.*

ITEM 7: AIRCRAFT IDENTIFICATION (MAXIMUM 7 CHARACTERS)

INSERT one of the following aircraft identifications, not exceeding 7 alphanumeric characters and without hyphens or symbols:

- a) the ICAO designator for the aircraft operating agency followed by the flight identification (e.g. KLM511, NGA213, JTR25) when in radiotelephony the call sign to be used by the aircraft will consist of the ICAO telephony designator for the operating agency followed by the flight identification (e.g. KLM511, NIGERIA 213, JESTER 25);

OR b) the nationality or common mark and registration mark of the aircraft (e.g. EIAKO, 4XBCD, N2567GA), when:

- 1) in radiotelephony the call sign to be used by the aircraft will consist of this identification alone (e.g. CGAJS), or preceded by the ICAO telephony designator for the aircraft operating agency (e.g. BLIZZARD CGAJS);

- 2) the aircraft is not equipped with radio.

Note 1.— Standards for nationality, common and registration marks to be used are contained in Annex 7, section 3.

Note 2.— Provisions for the use of radiotelephony call signs are contained in Annex 10, Volume II, Chapter 5. ICAO designators and telephony designators for aircraft operating agencies are contained in Doc 8585 — Designators for Aircraft Operating Agencies, Aeronautical Authorities and Services.

**ITEM 8: FLIGHT RULES AND TYPE OF
FLIGHT (ONE OR TWO CHARACTERS)**

Flight rules

INSERT one of the following letters to denote the category of flight rules with which the pilot intends to comply:

- I if it is intended that the entire flight will be operated under the IFR
- V if it is intended that the entire flight will be operated under the VFR
- Y if the flight initially will be operated under the IFR, followed by one or more subsequent changes of flight rules or
- Z if the flight initially will be operated under the VFR, followed by one or more subsequent changes of flight rules

Specify in Item 15 the point or points at which a change of flight rules is planned.

Type of flight

INSERT one of the following letters to denote the type of flight when so required by the appropriate ATS authority:

- S if scheduled air service
- N if non-scheduled air transport operation
- G if general aviation
- M if military
- X if other than any of the defined categories above.

Specify status of a flight following the indicator STS in Item 18, or when necessary to denote other reasons for specific handling by ATS, indicate the reason following the indicator RMK in Item 18.

**ITEM 9: NUMBER AND TYPE OF AIRCRAFT
AND WAKE TURBULENCE CATEGORY**

Number of aircraft (1 or 2 characters)

INSERT the number of aircraft, if more than one.

Type of aircraft (2 to 4 characters)

INSERT the appropriate designator as specified in ICAO Doc 8643, *Aircraft Type Designators*,

OR, if no such designator has been assigned, or in case of formation flights comprising more than one type,

INSERT ZZZZ, and *SPECIFY* in Item 18, the (numbers and) type(s) of aircraft preceded by TYP/ .

Wake turbulence category (1 character)
--

INSERT an oblique stroke followed by one of the following letters to indicate the wake turbulence category of the aircraft:

H — HEAVY, to indicate an aircraft type with a maximum certificated take-off mass of 136 000 kg or more;

M — MEDIUM, to indicate an aircraft type with a maximum certificated take-off mass of less than 136 000 kg but more than 7 000 kg;

L — LIGHT, to indicate an aircraft type with a maximum certificated take-off mass of 7 000 kg or less.

ITEM 10: EQUIPMENT AND CAPABILITIES
--

Capabilities comprise the following elements:

- a) presence of relevant serviceable equipment on board the aircraft;
- b) equipment and capabilities commensurate with flight crew qualifications; and
- c) where applicable, authorization from the appropriate authority.

Radiocommunication, navigation and approach aid equipment and capabilities
--

INSERT one letter as follows:

N if no COM/NAV/approach aid equipment for the route to be flown is carried, or the equipment is unserviceable,

OR S if standard COM/NAV/approach aid equipment for the route to be flown is carried and serviceable (*see Note 1*),

AND/OR

INSERT one or more of the following letters to indicate the serviceable COM/NAV/approach aid equipment and capabilities available:

A	GBAS landing system	J6	CPDLC FANS 1/A
B	LPV (APV with SBAS)		SATCOM (MTSAT)
C	LORAN C	J7	CPDLC FANS 1/A SATCOM (Iridium)
D	DME	K	MLS
E1	FMC WPR ACARS	L	ILS
E2	D-FIS ACARS	M1	ATC SATVOICE (INMARSAT)
E3	PDC ACARS	M2	ATC SATVOICE (MTSAT)
F	ADF	M3	ATC SATVOICE (Iridium)
G	GNSS. If any portion of the flight is planned to be conducted under IFR, it refers to GNSS receivers that comply with the requirements of Annex 10, Volume I (See Note 2)	O	VOR
		P1	CPDLC RCP 400 (See Note 7)
		P2	CPDLC RCP 240 (See Note 7)
		P3	SATVOICE RCP 400 (See Note 7)
		P4-P9	Reserved for RCP
H	HF RTF	R	PBN approved (See Note 4)
I	Inertial Navigation	T	TACAN
J1	CPDLC ATN VDL Mode 2 (See Note 3)	U	UHF RTF
J2	CPDLC FANS 1/A HFDL	V	VHF RTF
J3	CPDLC FANS 1/A VDL Mode A	W	RVSM approved
J4	CPDLC FANS 1/A VDL Mode 2	X	MNPS approved
J5	CPDLC FANS 1/A SATCOM (INMARSAT)	Y	VHF with 8.33 kHz channel spacing capability
		Z	Other equipment carried or other capabilities (See Note 5)

Any alphanumeric characters not indicated above are reserved.

Note 1.— If the letter S is used, standard equipment is considered to be VHF RTF, VOR and ILS, unless another combination is prescribed by the appropriate ATS authority.

Note 2.— If the letter G is used, the types of external GNSS augmentation, if any, are specified in Item 18 following the indicator NAV/ and separated by a space.

Note 3.— See RTCA/EUROCAE Interoperability Requirements Standard for ATN Baseline 1 (ATN B1 INTEROP Standard – DO-280B/ED-110B) for data link services air traffic control clearance and information/air traffic control communications management/air traffic control microphone check.

Note 4.— If the letter R is used, the performance-based navigation levels that can be met are specified in Item 18 following the indicator PBN/. Guidance material on the application of performance-based navigation to a specific route segment, route or area is contained in the Performance-based Navigation (PBN) Manual (Doc 9613).

Note 5.— If the letter Z is used, specify in Item 18 the other equipment carried or other capabilities, preceded by COM/ , NAV/ and/or DAT, as appropriate.

Note 6.— Information on navigation capability is provided to ATC for clearance and routing purposes.

Note 7.— Guidance material on the application of performance-based communication, which prescribes RCP to an air traffic service in a specific area, is contained in the Performance-based Communication and Surveillance (PBCS) Manual (Doc 9869).

Surveillance equipment
and capabilities

INSERT N if no surveillance equipment for the route to be flown is carried, or the equipment is unserviceable,
OR

INSERT one or more of the following descriptors, to a maximum of 20 characters, to describe the serviceable surveillance equipment and/or capabilities on board:

SSR Modes A and C

- A Transponder — Mode A (4 digits — 4 096 codes)
- C Transponder — Mode A (4 digits — 4 096 codes) and Mode C

SSR Mode S

- E Transponder — Mode S, including aircraft identification, pressure-altitude and extended squitter (ADS-B) capability
- H Transponder — Mode S, including aircraft identification, pressure-altitude and enhanced surveillance capability
- I Transponder — Mode S, including aircraft identification, but no pressure-altitude capability
- L Transponder — Mode S, including aircraft identification, pressure-altitude, extended squitter (ADS-B) and enhanced surveillance capability
- P Transponder — Mode S, including pressure-altitude, but no aircraft identification capability
- S Transponder — Mode S, including both pressure altitude and aircraft identification capability
- X Transponder — Mode S with neither aircraft identification nor pressure-altitude capability

Note.— *Enhanced surveillance capability is the ability of the aircraft to down-link aircraft derived data via a Mode S transponder.*

ADS-B

- B1 ADS-B with dedicated 1 090 MHz ADS-B “out” capability
- B2 ADS-B with dedicated 1 090 MHz ADS-B “out” and “in” capability
- U1 ADS-B “out” capability using UAT
- U2 ADS-B “out” and “in” capability using UAT
- V1 ADS-B “out” capability using VDL Mode 4
- V2 ADS-B “out” and “in” capability using VDL Mode 4

ADS-C

- D1 ADS-C with FANS 1/A capabilities
- G1 ADS-C with ATN capabilities

Alphanumeric characters not indicated above are reserved.

Example: ADE3RV/HB2U2V2G1

Note 1.— *The RSP specification(s), if applicable, will be listed in Item 18 following the indicator SUR/. Guidance material on the application of performance-based surveillance, which prescribes RSP to an air traffic service in a specific area, is contained in the Performance-based Communication and Surveillance (PBCS) Manual (Doc 9869).*

Note 2.— Additional surveillance equipment or capabilities will be listed in Item 18 following the indicator SUR/, as required by the appropriate ATS authority.

**ITEM 13: DEPARTURE AERODROME
AND TIME (8 CHARACTERS)**

INSERT the ICAO four-letter location indicator of the departure aerodrome as specified in Doc 7910, *Location Indicators*,

OR, if no location indicator has been assigned,

INSERT ZZZZ and *SPECIFY*, in Item 18, the name and location of the aerodrome preceded by DEP/ ,

OR, the first point of the route or the marker radio beacon preceded by DEP/..., if the aircraft has not taken off from the aerodrome,

OR, if the flight plan is received from an aircraft in flight,

INSERT AFIL, and *SPECIFY*, in Item 18, the ICAO four-letter location indicator of the location of the ATS unit from which supplementary flight plan data can be obtained, preceded by DEP/ .

THEN, WITHOUT A SPACE,

INSERT for a flight plan submitted before departure, the estimated off-block time (EOBT),

OR, for a flight plan received from an aircraft in flight, the actual or estimated time over the first point of the route to which the flight plan applies.

ITEM 15: ROUTE

INSERT the *first cruising speed* as in (a) and the *first cruising level* as in (b), without a space between them.

THEN, following the arrow, *INSERT* the route description as in (c).

(a) Cruising speed (maximum 5 characters)

INSERT the *True airspeed* for the first or the whole cruising portion of the flight, in terms of:

Kilometres per hour, expressed as K followed by 4 figures (e.g. K0830), *or*

Knots, expressed as N followed by 4 figures (e.g. N0485), *or*

True Mach number, when so prescribed by the appropriate ATS authority, to the nearest hundredth of unit Mach, expressed as M followed by 3 figures (e.g. M082).

(b) Cruising level (maximum 5 characters)

INSERT the planned cruising level for the first or the whole portion of the route to be flown, in terms of:

Flight level, expressed as F followed by 3 figures (e.g. F085; F330), *or*

**Standard metric level in tens of metres*, expressed as S followed by 4 figures (e.g. S1130), *or*

Altitude in hundreds of feet, expressed as A followed by 3 figures (e.g. A045; A100), *or*

Altitude in tens of metres, expressed as M followed by 4 figures (e.g. M0840), *or*

for uncontrolled VFR flights, the letters VFR.

(c) Route (including changes of speed, level and/or flight rules)
--

Flights along designated ATS routes

INSERT, if the departure aerodrome is located on or connected to the ATS route, the designator of the first ATS route,

OR, if the departure aerodrome is not on or connected to the ATS route, the letters DCT followed by the point of joining the first ATS route, followed by the designator of the ATS route.

THEN

INSERT each point at which either a change of speed and/or level is planned to commence, or a change of ATS route, and/or a change of flight rules is planned,

Note.— When a transition is planned between a lower and upper ATS route and the routes are oriented in the same direction, the point of transition need not be inserted.

FOLLOWED IN EACH CASE

by the designator of the next ATS route segment, even if the same as the previous one,

OR by DCT, if the flight to the next point will be outside a designated route, unless both points are defined by geographical coordinates.

Flights outside designated ATS routes

INSERT points normally not more than 30 minutes flying time or 370 km (200 NM) apart, including each point at which a change of speed or level, a change of track, or a change of flight rules is planned.

OR, when required by appropriate ATS authority(ies),

DEFINE the track of flights operating predominantly in an east-west direction between 70°N and 70°S by reference to significant points formed by the intersections of half or whole degrees of latitude with meridians spaced at

* When so prescribed by the appropriate ATS authorities.

intervals of 10 degrees of longitude. For flights operating in areas outside those latitudes the tracks shall be defined by significant points formed by the intersection of parallels of latitude with meridians normally spaced at 20 degrees of longitude. The distance between significant points shall, as far as possible, not exceed one hour's flight time. Additional significant points shall be established as deemed necessary.

For flights operating predominantly in a north-south direction, define tracks by reference to significant points formed by the intersection of whole degrees of longitude with specified parallels of latitude which are spaced at 5 degrees.

INSERT DCT between successive points unless both points are defined by geographical coordinates or by bearing and distance.

USE ONLY the conventions in (1) to (5) below and *SEPARATE* each sub-item by a space.

(1) ATS route (2 to 7 characters)

The coded designator assigned to the route or route segment including, where appropriate, the coded designator assigned to the standard departure or arrival route (e.g. BCN1, BI, R14, UB10, KODAP2A).

Note.— Provisions for the application of route designators are contained in Annex 11, Appendix 1.

(2) Significant point (2 to 11 characters)

The coded designator (2 to 5 characters) assigned to the point (e.g. LN, MAY, HADDY),

or, if no coded designator has been assigned, one of the following ways:

— *Degrees only* (7 characters):

2 figures describing latitude in degrees, followed by “N” (North) or “S” (South), followed by 3 figures describing longitude in degrees, followed by “E” (East) or “W” (West). Make up the correct number of figures, where necessary, by insertion of zeros, e.g. 46N078W.

— *Degrees and minutes* (11 characters):

4 figures describing latitude in degrees and tens and units of minutes followed by “N” (North) or “S” (South), followed by 5 figures describing longitude in degrees and tens and units of minutes, followed by “E” (East) or “W” (West). Make up the correct number of figures, where necessary, by insertion of zeros, e.g. 4620N07805W.

— *Bearing and distance from a reference point*:

The identification of the reference point, followed by the bearing from the point in the form of 3 figures giving degrees magnetic, followed by the distance from the point in the form of 3 figures expressing nautical miles. In areas of high latitude where it is determined by the appropriate authority that reference to degrees magnetic is impractical, degrees true may be used. Make up the correct number of figures, where necessary, by insertion of zeros — e.g. a point 180° magnetic at a distance of 40 nautical miles from VOR “DUB” should be expressed as DUB180040.

- (3) Change of speed or level
(maximum 21 characters)

The point at which a change of speed (5% TAS or 0.01 Mach or more) or a change of level is planned to commence, expressed exactly as in (2) above, followed by an oblique stroke and both the cruising speed and the cruising level, expressed exactly as in (a) and (b) above, without a space between them, even when only one of these quantities will be changed.

Examples: LN/N0284A045
 MAY/N0305F180
 HADDY/N0420F330
 4602N07805W/N0500F350
 46N078W/M082F330
 DUB180040/N0350M0840

- (4) Change of flight rules
(maximum 3 characters)

The point at which the change of flight rules is planned, expressed exactly as in (2) or (3) above as appropriate, followed by a space and one of the following:

VFR if from IFR to VFR
 IFR if from VFR to IFR

Examples: LN VFR
 LN/N0284A050 IFR

- (5) Cruise climb (maximum 28 characters)

The letter C followed by an oblique stroke; THEN the point at which cruise climb is planned to start, expressed exactly as in (2) above, followed by an oblique stroke; THEN the speed to be maintained during cruise climb, expressed exactly as in (a) above, followed by the two levels defining the layer to be occupied during cruise climb, each level expressed exactly as in (b) above, or the level above which cruise climb is planned followed by the letters PLUS, without a space between them.

Examples: C/48N050W/M082F290F350
 C/48N050W/M082F290PLUS
 C/52N050W/M220F580F620.

**ITEM 16: DESTINATION AERODROME AND
TOTAL ESTIMATED ELAPSED TIME,
DESTINATION ALTERNATE AERODROME(S)**

Destination aerodrome and total
estimated elapsed time (8 characters)

INSERT the ICAO four-letter location indicator of the destination aerodrome as specified in Doc 7910, *Location Indicators*,

OR, if no location indicator has been assigned,

INSERT ZZZZ and *SPECIFY* in Item 18 the name and location of the aerodrome, preceded by DEST/ .

THEN WITHOUT A SPACE

INSERT the total estimated elapsed time.

Note.— *For a flight plan received from an aircraft in flight, the total estimated elapsed time is the estimated time from the first point of the route to which the flight plan applies to the termination point of the flight plan.*

Destination alternate aerodrome(s)

INSERT the ICAO four-letter location indicator(s) of not more than two destination alternate aerodromes, as specified in Doc 7910, *Location Indicators*, separated by a space,

OR, if no location indicator has been assigned to the destination alternate aerodrome(s),

INSERT ZZZZ and *SPECIFY* in Item 18 the name and location of the destination alternate aerodrome(s), preceded by ALTN/ .

ITEM 18: OTHER INFORMATION

Note.— *Use of indicators not included under this item may result in data being rejected, processed incorrectly or lost.*

Hyphens or oblique strokes should only be used as prescribed below.

INSERT 0 (zero) if no other information,

OR, any other necessary information in the sequence shown hereunder, in the form of the appropriate indicator selected from those defined hereunder followed by an oblique stroke and the information to be recorded:

STS/ Reason for special handling by ATS, e.g. a search and rescue mission, as follows:

ALTRV:	for a flight operated in accordance with an altitude reservation;
ATFMX:	for a flight approved for exemption from ATFM measures by the appropriate ATS authority;
FFR:	fire-fighting;
FLTCK:	flight check for calibration of nav aids;
HAZMAT:	for a flight carrying hazardous material;
HEAD:	a flight with Head of State status;
HOSP:	for a medical flight declared by medical authorities;
HUM:	for a flight operating on a humanitarian mission;
MARSA:	for a flight for which a military entity assumes responsibility for separation of military aircraft;
MEDEVAC:	for a life critical medical emergency evacuation;
NONRVSM:	for a non-RVSM capable flight intending to operate in RVSM airspace;
SAR:	for a flight engaged in a search and rescue mission; and
STATE:	for a flight engaged in military, customs or police services.

Other reasons for special handling by ATS shall be denoted under the designator RMK/.

PBN/ Indication of RNAV and/or RNP capabilities. Include as many of the descriptors below, as apply to the flight, up to a maximum of 8 entries, i.e. a total of not more than 16 characters.

	RNAV SPECIFICATIONS
A1	RNAV 10 (RNP 10)
B1	RNAV 5 all permitted sensors
B2	RNAV 5 GNSS
B3	RNAV 5 DME/DME
B4	RNAV 5 VOR/DME
B5	RNAV 5 INS or IRS
B6	RNAV 5 LORANC
C1	RNAV 2 all permitted sensors
C2	RNAV 2 GNSS
C3	RNAV 2 DME/DME
C4	RNAV 2 DME/DME/IRU
D1	RNAV 1 all permitted sensors
D2	RNAV 1 GNSS
D3	RNAV 1 DME/DME
D4	RNAV 1 DME/DME/IRU
	RNP SPECIFICATIONS
L1	RNP 4
O1	Basic RNP 1 all permitted sensors
O2	Basic RNP 1 GNSS
O3	Basic RNP 1 DME/DME
O4	Basic RNP 1 DME/DME/IRU
S1	RNP APCH
S2	RNP APCH with BARO-VNAV
T1	RNP AR APCH with RF (special authorization required)
T2	RNP AR APCH without RF (special authorization required)

Combinations of alphanumeric characters not indicated above are reserved.

NAV/ Significant data related to navigation equipment, other than specified in PBN/, as required by the appropriate ATS authority. Indicate GNSS augmentation under this indicator, with a space between two or more methods of augmentation, e.g. NAV/GBAS SBAS.

COM/ Indicate communication equipment and capabilities not specified in Item 10 a).

DAT/ Indicate data communication equipment and capabilities not specified in 10 a).

SUR/ Indicate surveillance equipment and capabilities not specified in Item 10 b). Indicate as many RSP specification(s) as apply to the flight, using designator(s) with no space. Multiple RSP specifications are separated by a space. Example: RSP180 RSP400.

DEP/ Name and location of departure aerodrome, if ZZZZ is inserted in Item 13, or the ATS unit from which supplementary flight plan data can be obtained, if AFIL is inserted in Item 13. For aerodromes not listed in the relevant Aeronautical Information Publication, indicate location as follows:
With 4 figures describing latitude in degrees and tens and units of minutes followed by “N” (North) or “S” (South), followed by 5 figures describing longitude in degrees and tens and units of minutes, followed by “E” (East) or “W” (West). Make up the correct number of figures, where necessary, by insertion of zeros, e.g. 4620N07805W (11 characters).

OR, Bearing and distance from the nearest significant point, as follows:

The identification of the significant point followed by the bearing from the point in the form of 3 figures giving degrees magnetic, followed by the distance from the point in the form of 3 figures expressing nautical miles. In areas of high latitude where it is determined by the appropriate authority that reference to degrees magnetic is impractical, degrees true may be used. Make up the correct number of figures, where necessary, by insertion of zeros, e.g. a point of 180° magnetic at a distance of 40 nautical miles from VOR “DUB” should be expressed as DUB180040.

OR, The first point of the route (name or LAT/LONG) or the marker radio beacon, if the aircraft has not taken off from an aerodrome.

DEST/ Name and location of destination aerodrome, if ZZZZ is inserted in Item 16. For aerodromes not listed in the relevant Aeronautical Information Publication, indicate location in LAT/LONG or bearing and distance from the nearest significant point, as described under DEP/ above.

DOF/ The date of flight departure in a six-figure format (YYMMDD, where YY equals the year, MM equals the month and DD equals the day).

REG/ The nationality or common mark and registration mark of the aircraft, if different from the aircraft identification in Item 7.

EET/ Significant points or FIR boundary designators and accumulated estimated elapsed times from take-off to such points or FIR boundaries, when so prescribed on the basis of regional air navigation agreements, or by the appropriate ATS authority.

Examples: EET/CAP0745 XYZ0830
EET/EINN0204

SEL/ SELCAL Code, for aircraft so equipped.

- TYP/ Type(s) of aircraft, preceded if necessary without a space by number(s) of aircraft and separated by one space, if ZZZZ is inserted in Item 9.
- Example: TYP/2F15 5F5 3B2
- CODE/ Aircraft address (expressed in the form of an alphanumerical code of six hexadecimal characters) when required by the appropriate ATS authority. Example: “F00001” is the lowest aircraft address contained in the specific block administered by ICAO.
- DLE/ Enroute delay or holding, insert the significant point(s) on the route where a delay is planned to occur, followed by the length of delay using four-figure time in hours and minutes (hhmm).
- Example: DLE/MDG0030
- OPR/ ICAO designator or name of the aircraft operating agency, if different from the aircraft identification in item 7.
- ORGN/ The originator’s 8 letter AFTN address or other appropriate contact details, in cases where the originator of the flight plan may not be readily identified, as required by the appropriate ATS authority.
- Note.— In some areas, flight plan reception centres may insert the ORGN/ identifier and originator’s AFTN address automatically.*
- PER/ Aircraft performance data, indicated by a single letter as specified in the *Procedures for Air Navigation Services — Aircraft Operations* (PANS-OPS, Doc 8168), *Volume I — Flight Procedures*, if so prescribed by the appropriate ATS authority.
- ALTN/ Name of destination alternate aerodrome(s), if ZZZZ is inserted in Item 16. For aerodromes not listed in the relevant Aeronautical Information Publication, indicate location in LAT/LONG or bearing and distance from the nearest significant point, as described in DEP/ above.
- RALT/ ICAO four letter indicator(s) for en-route alternate(s), as specified in Doc 7910, *Location Indicators*, or name(s) of en-route alternate aerodrome(s), if no indicator is allocated. For aerodromes not listed in the relevant Aeronautical Information Publication, indicate location in LAT/LONG or bearing and distance from the nearest significant point, as described in DEP/ above.
- TALT/ ICAO four letter indicator(s) for take-off alternate, as specified in Doc 7910, *Location Indicators*, or name of take-off alternate aerodrome, if no indicator is allocated. For aerodromes not listed in the relevant Aeronautical Information Publication, indicate location in LAT/LONG or bearing and distance from the nearest significant point, as described in DEP/ above.
- RIF/ The route details to the revised destination aerodrome, followed by the ICAO four-letter location indicator of the aerodrome. The revised route is subject to reclearance in flight.
- Examples: RIF/DTA HEC KLAX
RIF/ESP G94 CLA YPPH
- RMK/ Any other plain-language remarks when required by the appropriate ATS authority or deemed necessary.

ITEM 19: SUPPLEMENTARY INFORMATION

Endurance

After E/ *INSERT* a 4-figure group giving the fuel endurance in hours and minutes.

Persons on board

After P/ *INSERT* the total number of persons (passengers and crew) on board, when required by the appropriate ATS authority. *INSERT* TBN (to be notified) if the total number of persons is not known at the time of filing.

Emergency and survival equipment

R/ (RADIO) *CROSS OUT* U if UHF on frequency 243.0 MHz is not available. *CROSS OUT* V if VHF on frequency 121.5 MHz is not available. *CROSS OUT* E if emergency locator transmitter (ELT) is not available.

S/ (SURVIVAL EQUIPMENT) *CROSS OUT* all indicators if survival equipment is not carried. *CROSS OUT* P if polar survival equipment is not carried. *CROSS OUT* D if desert survival equipment is not carried. *CROSS OUT* M if maritime survival equipment is not carried. *CROSS OUT* J if jungle survival equipment is not carried.

J/ (JACKETS) *CROSS OUT* all indicators if life jackets are not carried. *CROSS OUT* L if life jackets are not equipped with lights. *CROSS OUT* F if life jackets are not equipped with fluorescein. *CROSS OUT* U or V or both as in R/ above to indicate radio capability of jackets, if any.

D/ (DINGHIES) *CROSS OUT* indicators D and C if no dinghies are carried, or *INSERT* number of dinghies carried; and

(CAPACITY) *INSERT* total capacity, in persons, of all dinghies carried; and

(COVER) *CROSS OUT* indicator C if dinghies are not covered; and

(COLOUR) *INSERT* colour of dinghies if carried.

A/ (AIRCRAFT COLOUR AND MARKINGS) *INSERT* colour of aircraft and significant markings.

N/ (REMARKS) *CROSS OUT* indicator N if no remarks, or *INDICATE* any other survival equipment carried and any other remarks regarding survival equipment.

C/ (PILOT) *INSERT* name of pilot-in-command.

2.3 Filed by

INSERT the name of the unit, agency or person filing the flight plan.

2.4 Acceptance of the flight plan

Indicate acceptance of the flight plan in the manner prescribed by the appropriate ATS authority.

2.5 Instructions for insertion of COM data

Items to be completed

COMPLETE the top two shaded lines of the form, and *COMPLETE* the third shaded line only when necessary, in accordance with the provisions in PANS-ATM, Chapter 11, 11.2.1.2, unless ATS prescribes otherwise.

3. Instructions for the transmission of a filed flight plan (FPL) message

Correction of obvious errors

Unless otherwise prescribed, *CORRECT* obvious format errors and/or omissions (i.e. oblique strokes) to ensure adherence as specified in Section 2.

Items to be transmitted

TRANSMIT items as indicated hereunder, unless otherwise prescribed:

- a) the items in the shaded lines, above Item 3;
- b) commencing with <<≡ (FPL of Item 3:

all symbols and data in the unshaded boxes down to the)<<≡ at the end of Item 18,

additional alignment functions as necessary to prevent the inclusion of more than 69 characters in any line of Items 15 or 18. The alignment function is to be inserted only in lieu of a space so as not to break up a group of data,

letter shifts and figure shifts (not preprinted on the form) as necessary;

- c) the AFTN Ending, as described below:

End-of-Text Signal

- a) one LETTER SHIFT
- b) two CARRIAGE RETURNS, one LINE FEED

Page-feed Sequence

Seven LINE FEEDS

End-of-Message Signal

Four of the letter N.

4. Instructions for the transmission of a supplementary flight plan (SPL) message

Items to be transmitted

Transmit items as indicated hereunder, unless otherwise prescribed:

- a) AFTN Priority Indicator, Addressee Indicators <<≡, Filing Time, Originator Indicator <<≡ and, if necessary, specific identification of addressees and/or originator;

- b) commencing with <<≡ (SPL:

all symbols and data in the unshaded areas of boxes 7, 13, 16 and 18, except that the ‘)’ at the end of box 18 is *not* to be transmitted, and then the symbols in the unshaded area of box 19 down to and including the)<<≡ of box 19,

additional alignment functions as necessary to prevent the inclusion of more than 69 characters in any line of Items 18 and 19. The alignment function is to be inserted only in lieu of a space so as not to break up a group of data,

letter shifts and figure shifts (not preprinted on the form) as necessary;

- c) the AFTN Ending, as described below:

End-of-Text Signal

- a) one LETTER SHIFT
 b) two CARRIAGE RETURNS, one LINE FEED

Page-feed Sequence

Seven LINE FEEDS

End-of-Message Signal

Four of the letter N.

5. Example of a completed flight plan form

FLIGHT PLAN PLAN DE VOL			
PRIORITY Priorité <<< FF >>>	ADDRESSEE(S) Destinataire(s) EHAA ZQZX EBURZQZX EDDYZQZX LFFFZQZX LFRR ZQZX LFBZQZX LECMZQZX LPPCZQZX		
FILING TIME Heure de dépôt 1,9 0,8 3,6 →	ORIGINATOR Expéditeur E, H, A, M, Z, P, Z, X <<<		
SPECIFIC IDENTIFICATION OF ADDRESSEE(S) AND/OR ORIGINATOR Identification précise du(des) destinataire(s) et/ou de l'expéditeur			
3 MESSAGE TYPE Type de message <<< (FPL)	7 AIRCRAFT IDENTIFICATION Identification de l'aéronef — A C F 4 0 2	8 FLIGHT RULES Règles de vol — I	TYPE OF FLIGHT Type de vol N <<<
9 NUMBER Nombre —	TYPE OF AIRCRAFT Type d'aéronef E, A, 3, 0	WAKE TURBULENCE CAT. Cat. de turbulence de sillage / H	10 EQUIPMENT Équipement — S / C <<<
13 DEPARTURE AERODROME Aérodrome de départ — E, H, A, M		TIME Heure 0,9 4,0 <<<	
15 CRUISING SPEED Vitesse croisière — K, 0, 8, 3, 0			
LEVEL Niveau F, 2, 9, 0		ROUTE Route LEK2B LEK UA6 XMM/MO78 F330	
UA6 PON URION CHW UA5 NTS DCT 4611N00412W DCT STG UA5 FTM FATIM1A			
<<<<<			
16 DESTINATION AERODROME Aérodrome de destination — L, P, P, T		TOTAL EET Durée totale estimée HR MIN 0,2 3,0	ALTN AERODROME Aérodrome de dégagement → L, P, P, R
18 OTHER INFORMATION Renseignements divers — REG / FBVGA SEL / EJFL EET / LPPC0158			
) <<<<<			
SUPPLEMENTARY INFORMATION (NOT TO BE TRANSMITTED IN FPL MESSAGES) Renseignements complémentaires (À NE PAS TRANSMETTRE DANS LES MESSAGES DE PLAN DE VOL DÉPOSÉ)			
19 ENDURANCE Autonomie — E / 0,3 4,5		PERSONS ON BOARD Personnes à bord → P / 3,0 0	
SURVIVAL EQUIPMENT/Équipement de survie → S / R DINGHIES/Canots		JACKETS/Gilets de sauvetage → J / L LIGHT Lampes	
POLAR P DESERT D MARITIME M JUNGLE J		FLUORES F UHF U VHF V ELT E	
NUMBER 1,1 → CAPACITY 3,3,0 → COVER C → COLOUR YELLOW <<<<			
AIRCRAFT COLOUR AND MARKINGS Couleur et marques de l'aéronef A / WHITE			
REMARKS Remarques → N			
PILOT-IN-COMMAND Pilote commandant de bord C / DENKE) <<<<<			
FILED BY / Déposé par			
AIR CHARTER INT.		SPACE RESERVED FOR ADDITIONAL REQUIREMENTS Espace réservé à des fins supplémentaires	

6. ICAO model repetitive flight plan (RPL) listing form

REPETITIVE FLIGHT PLAN LISTING

A OPERATOR			B ADDRESSEE(S)				C DEPARTURE AERODROME(S)			D	E	F						
										DATE ----- yymmdd	SERIAL NO. - - - - - -	PAGE OF - - / - -						
G SUPPLEMENTARY DATA (Item 19) AT:																		
H	I	J	K							L	M	N	O			P	Q	
	VALID FROM	VALID UNTIL	DAYS OF OPERATION							AIRCRAFT IDENTIFICATION (Item 7)	TYPE OF AIRCRAFT AND WAKE TURBULENCE CATEGORY (Item 9)	DEPARTURE AERODROME AND TIME (Item 13)	CRUISING		ROUTE (Item 15)		DESTINATION AERODROME AND TOTAL ESTIMATED ELAPSED TIME (Item 16)	REMARKS
+ -	yymmdd	yymmdd	1	2	3	4	5	6	7			SPEED	LEVEL	ROUTE				

7. Instructions for the completion of the repetitive flight plan (RPL) listing form

7.1 General

List only flight plans that will operate in accordance with IFR. (Flight rules I in FPL format).

It is assumed that all aircraft are operating as scheduled flights (Type of flight S in FPL format), otherwise *notify* in Q (Remarks).

It is assumed that all aircraft operating on RPLs are equipped with 4 096-code transponders with Modes A and C. Otherwise, *notify* in Q (Remarks).

List flight plans in *alphabetical order of the location indicator of the departure aerodrome*.

List flight plans for each departure aerodrome in chronological order of estimated off-block times.

Adhere closely to the data conventions as indicated for the Flight Plan Form (Appendix 3, 1.6) unless otherwise specifically indicated in 7.4.

Insert all clock times in 4 figures UTC.

Insert all estimated elapsed times in 4 figures (hours and minutes).

Insert data on a separate line for each segment of operations with one or more stops, i.e. from any departure aerodrome to the next destination aerodrome even though call sign or flight number is the same for multiple segments.

Clearly identify additions and deletions in accordance with Item H at 7.4. Subsequent listings shall list the corrected and added data, and deleted flight plans shall be omitted.

Number pages by indicating number of page and total number of pages in submission.

Utilize more than one line for any RPL where the space provided for items O and Q on one line is not sufficient.

7.2 A flight shall be cancelled as follows:

- a) indicate a minus sign in Item H followed by all other items of the cancelled flight;
- b) insert a subsequent entry denoted by a plus sign in Item H and the date of the last flight in Item J, with all other items of the cancelled flight unchanged.

7.3 Modification to a flight shall be made as follows:

- a) carry out the cancellation as indicated in 7.2; and
- b) insert a third entry giving the new flight plan(s) with the appropriate items modified as necessary, including the new validity dates in Items I and J.

Note.— *All entries related to the same flight will be inserted in succession in the order specified above.*

7.4 Instructions for insertion of RPL data

Complete Items A to Q as indicated hereunder.

ITEM A: OPERATOR

INSERT name of operator.

ITEM B: ADDRESSEE(S)

INSERT name of agency(ies) designated by States to administer RPLs for FIRs or areas of responsibility concerned with the route of flight.

ITEM C: DEPARTURE AERODROME(S)

INSERT location indicator(s) of departure aerodrome(s).

ITEM D: DATE

INSERT on each page of submission the date (year, month, day) in a 6-figure group that the listing was submitted.

ITEM E: SERIAL NO.

INSERT serial number of submission (2 numerics) indicating last two digits of year, a dash, and the sequential no. of the submission for the year indicated (start with numeral 1 each new year).

ITEM F: PAGE OF

INSERT page number and total number of pages submitted.

ITEM G: SUPPLEMENTARY DATA AT

INSERT name and appropriate contact details of entity where information normally provided under Item 19 of the FPL is kept readily available and can be supplied without delay.

ITEM H: ENTRY TYPE

INSERT a minus sign (–) for each flight plan that is to be deleted from the listing.

INSERT a plus sign (+) for each initial listing and, in the case of subsequent submissions, for each flight plan not listed in the previous submission.

Note.— No information is required under this item for any flight plan which is unchanged from the previous submission.

ITEM I: VALID FROM

INSERT first date (year, month, day) upon which the flight is scheduled to operate.

ITEM J: VALID UNTIL

INSERT last date (year, month, day) upon which the flight is scheduled to operate as listed, or
UFN if the duration is unknown.

ITEM K: DAYS OF OPERATION

INSERT number corresponding to the day of the week in the appropriate column;
Monday = 1 through Sunday = 7.

INSERT 0 for each day of non-operation in the appropriate column.

ITEM L: AIRCRAFT IDENTIFICATION

(Item 7 of the ICAO flight plan)

INSERT aircraft identification to be used for the flight.

**ITEM M: TYPE OF AIRCRAFT AND
WAKE TURBULENCE CATEGORY**

(Item 9 of the ICAO flight plan)

INSERT appropriate ICAO designator as specified in ICAO Doc 8643 — *Aircraft Type Designators*.

INSERT H, M or L indicator as appropriate:

H — HEAVY to indicate an aircraft type with a maximum certificated take-off mass of 136 000 kg or more,

M — MEDIUM to indicate an aircraft type with a maximum certificated take-off mass of less than 136 000 kg but more than 7 000 kg,

L — LIGHT to indicate an aircraft type with a maximum certificated take-off mass of 7 000 kg or less.

ITEM N: DEPARTURE AERODROME AND TIME

(Item 13 of the ICAO flight plan)

INSERT location indicator of the departure aerodrome.

INSERT the off-block time, i.e. the estimated time that the aircraft will commence movement associated with departure.

ITEM O: ROUTE

(Item 15 of the ICAO flight plan)

(a) Cruising speed

INSERT the true airspeed for the first or whole cruising portion of the flight in accordance with Item 15 (a) of the ICAO flight plan.

(b) Cruising level

INSERT the planned cruising level for the first or whole portion of the route in accordance with Item 15 (b) of the ICAO flight plan.

(c) Route

INSERT the entire route in accordance with Item 15 (c) of the ICAO flight plan.

**ITEM P: DESTINATION AERODROME AND
TOTAL ESTIMATED ELAPSED TIME**

(Item 16 of the ICAO flight plan)

INSERT location indicator of the destination aerodrome.

INSERT the total estimated elapsed time.

ITEM Q: REMARKS

INSERT items of information as required by the appropriate ATS authority, items normally notified in Item 18 of the ICAO flight plan and any other information pertinent to the flight of concern to ATS.

8. Example of a completed repetitive flight plan (RPL) listing form

REPETITIVE FLIGHT PLAN LISTING

A OPERATOR BRITISH AIRWAYS			B ADDRESSEE(S) UK STORED FLIGHT PLAN OFFICE EGTXZBZX Chef de la Subdivision informatique 9 rue de Champagne 91205 Athismons France										C DEPARTURE AERODROME(S) EGLL				D DATE 800305 ----- yyymmdd	E SERIAL NO. 80 - 12 --- ---	F PAGE OF 3 / 3 --/--	G SUPPLEMENTARY DATA (Item 19) AT: BAW Briefing Office	
H + -	I VALID FROM yyymmdd	J VALID UNTIL yyymmdd	K DAYS OF OPERATION							L AIRCRAFT IDENTIFICATION (Item 7)	M TYPE OF AIRCRAFT AND WAKE TURBULENCE CATEGORY (Item 9)	N DEPARTURE AERODROME AND TIME (Item 13)	O ROUTE (Item 15)			P DESTINATION AERODROME AND TOTAL ESTIMATED ELAPSED TIME (Item 16)		Q REMARKS			
			1	2	3	4	5	6	7				CRUISING SPEED	LEVEL	ROUTE						
+	800401	811031	1	2	3	4	5	6	7	BAW004	HS21 M	EGLL 0700	N0440	F210	A1E UA1E DPE UA16 MAN	LFPG	0045				
+	800401	800731	1	2	3	4	5	6	7	BAW032	HS21 M	EGLL 1800	N0440	F210	A1E UA1E DPE UA16 MAN	LFPG	0045				
+	800801	811031	1	0	3	0	5	0	7	BAW032	HS21 M	EGLL 1800	N0440	F210	A1E UA1E DPE UA16 MAN	LFPG	0045				
+	800601	800930	0	0	0	0	0	0	7	BAW082	HS21 M	EGLL 1805	N0450	F270	A1S UA1S RBT UA3 MTL						
															UA3W STP DCT GL	LFMN	0130				
-	800103	800930	0	0	0	0	0	6	7	BAW092	B737 M	EGLL 1810	N0430	F190	A1E UA1E DPE UA16 MAN	LFPG	0400	CHARTERED ACFT			
+	800103	800315	0	0	0	0	0	6	7	BAW092	B737 M	EGLL 1810	N0430	F190	A1E UA1E DPE UA16 MAN	LFPG	0400	CHARTERED ACFT			

Appendix 3

AIR TRAFFIC SERVICES MESSAGES

1. Message contents, formats and data conventions
2. Examples of ATS messages

1. Message contents, formats and data conventions

Note.— To facilitate description of the content and format of air traffic services messages, both for interchange between units without automatic data processing equipment and for interchange between air traffic control computers, the elements of data to be included in the message are grouped into “fields”. Each field contains a single element or a group of related elements.

1.1 The standard types of message

The standard types of message established for the interchange of ATS data, together with the associated message type designators, are as follows:

<i>Message category</i>	<i>Message type</i>	<i>Message type designator</i>
Emergency	Alerting	ALR
	Radiocommunication failure	RCF
Filed flight plan and associated update	Filed flight plan	FPL
	Modification	CHG
	Cancellation	CNL
	Delay	DLA
	Departure	DEP
	Arrival	ARR
Coordination	Current flight plan	CPL
	Estimate	EST
	Coordination	CDN
	Acceptance	ACP
	Logical acknowledgement	LAM
Supplementary	Request flight plan	RQP
	Request supplementary flight plan	RQS
	Supplementary flight plan	SPL

1.2 The standard types of field

The standard fields of data permitted in ATS messages are as shown in the following table. The numbers in column 1 correspond with those in the reference table on page A3-35.

<i>Field type</i>	<i>Data</i>
3	Message type, number and reference data
5	Description of emergency
7	Aircraft identification and SSR mode and code
8	Flight rules and type of flight
9	Number and type of aircraft and wake turbulence category
10	Equipment and capabilities
13	Departure aerodrome and time
14	Estimate data

<i>Field type</i>	<i>Data</i>
15	Route
16	Destination aerodrome and total estimated elapsed time, destination alternate aerodrome(s)
17	Arrival aerodrome and time
18	Other information
19	Supplementary information
20	Alerting search and rescue information
21	Radio failure information
22	Amendment

1.3 Composition of the standard types of message

The composition of each standard type of message, expressed as a standardized sequence of fields of data, shall be as prescribed in the reference table on page A3-35. Each message shall contain all the fields prescribed.

1.4 Composition of the standard types of field

The composition of each standard type of field, expressed as a standardized sequence of elements of data, or in some cases as a simple element, shall be as prescribed in the field tables on pages A3-6 to A3-34.

Note.— Each type of field contains at least one mandatory element and, except in Field Type 9, this is the first or only element in the field. The rules for the inclusion or omission of conditional elements are indicated in the field tables.

1.5 Structuring and punctuation

1.5.1 The beginning of the ATS data shall be indicated on page copy by an open bracket ‘(’, which constitutes the Start-of-ATS-Data Signal. This signal shall be used only as the printed character immediately preceding the message type designator.

Note.— In teletypewriter operation using International Telegraph Alphabet No. 2, the open bracket is transmitted as the Figures Case of Signal No. 11. On some teletypewriter machines, this will print as a symbol other than ‘(’, but this variation will be local and of no consequence. Where higher level codes are employed, the character printing as ‘(’ is used.

1.5.2 The beginning of each field, other than the first, shall be indicated by a single hyphen ‘-’, which constitutes the Start-of-Field Signal. This signal shall be used only as the printed character preceding the first element of ATS data in each field.

Note.— In teletypewriter operation using International Telegraph Alphabet No. 2, the single hyphen is transmitted as the Figures Case of Signal No. 1. On some teletypewriter machines, this will print as a symbol other than ‘-’, but this variation will be local and of no consequence. Where higher level codes are employed, the character printing as ‘-’ is used.

1.5.3 Elements within a field shall be separated by an oblique stroke ‘/’ (see Note 1), or a space (sp.) (see Note 2) only where so prescribed in the field tables on pages A3-6 to A3-34.

Note 1.— In teletypewriter operation using International Telegraph Alphabet No. 2, the oblique stroke is transmitted as the Figures Case of Signal No. 24. On some teletypewriter machines, this will print as a symbol other than ‘/’, but this variation will be local and of no consequence. Where higher level codes are employed, the character printing as ‘/’ is used.

Note 2.— In teletypewriter operation using International Telegraph Alphabet No. 2, the space is transmitted as Signal No. 31. Where higher level codes are employed, the character which causes a space on page copy is to be used.

1.5.4 The end of the ATS data shall be indicated by a close bracket ')', which constitutes the End-of-ATS-Data Signal. This signal shall be used only as the printed character immediately following the last field in the message.

Note.— In teletypewriter operation using International Telegraph Alphabet No. 2, the close bracket is transmitted as Signal No. 12. On some teletypewriter machines, this will print as a symbol other than ')', but this variation will be local and of no consequence. Where higher level codes are employed, the character printing as ') is to be used.

1.5.5 When the standard ATS messages are prepared in teletypewriter form, an Alignment Function (two Carriage Returns followed by one Line Feed) shall be inserted:

- a) prior to each of the fields so annotated in the reference table on page A3-35;
- b) in Fields Type 5 (Description of emergency), 15 (Route), 18 (Other information), 19 (Supplementary information), 20 (Alerting search and rescue information), 21 (Radio failure information) and 22 (Amendment), whenever it is necessary to begin a new line on page copy (see Note). In such cases, the Alignment Function shall be inserted between two data elements and shall not divide an element.

Note.— Annex 10, Volume II, prescribes that a line of teletypewriter copy shall not contain more than 69 characters.

1.6 Data conventions

1.6.1 Most of the conventions to be used in the expression of ATS data in the messages are prescribed in the field tables on pages A3-6 to A3-34, but the conventions for the expression of level, position and route data are given below to simplify the field tables.

1.6.2 The expression of level data

Four alternative conventions are available for the expression of level data:

- a) "F" followed by 3 decimal numerics: indicates a flight level number, i.e. Flight Level 330 is expressed as "F330";
- b) "S" followed by 4 decimal numerics: indicates standard metric level in tens of metres, i.e. Standard Metric Level 11 300 metres (Flight Level 370) is expressed as "S1130";
- c) "A" followed by 3 decimal numerics: indicates altitude in hundreds of feet, i.e. an altitude of 4 500 feet is expressed as "A045";
- d) "M" followed by 4 decimal numerics: indicates altitude in tens of metres, i.e. an altitude of 8 400 metres is expressed as "M0840".

1.6.3 The expression of position or route

The following alternative data conventions shall be used for the expression of position or route:

- a) from 2 to 7 characters, being the coded designator assigned to an ATS route to be flown;
- b) from 2 to 5 characters, being the coded designator assigned to an en-route point;
- c) 4 numerics describing latitude in degrees and tens and units of minutes, followed by “N” (meaning “North”) or “S” (South), followed by 5 numerics describing longitude in degrees and tens and units of minutes, followed by “E” (East) or “W” (West). The correct number of numerics is to be made up, where necessary, by the insertion of zeros, e.g. “4620N07805W”;
- d) 2 numerics describing latitude in degrees, followed by “N” (North) or “S” (South), followed by 3 numerics describing longitude in degrees, followed by “E” (East) or “W” (West). Again, the correct number of numerics is to be made up, where necessary, by the insertion of zeros, e.g. “46N078W”;
- e) 2 to 5 characters being the coded identification of a significant point, followed by 3 decimal numerics giving the bearing from the point in degrees magnetic followed by 3 decimal numerics giving the distance from the point in nautical miles. In areas of high latitude where it is determined by the appropriate authority that reference to degrees magnetic is impractical, degrees true may be used. The correct number of numerics is to be made up, where necessary, by the insertion of zeros, e.g. a point at 180° magnetic at a distance of 40 nautical miles from VOR “FOJ” would be expressed as “FOJ180040”.

1.7 The detail of the fields

1.7.1 The elements of data prescribed or permitted to be included in each type of field, together with a prescription of the conditions or options permitted, are shown on pages A3-6 to A3-34.

1.7.2 A key appears at the right-hand side of each of the field pages; this key permits the sequence of fields in each type of message to be followed.

1.7.3 The first field in each message type is Field Type 3; on the page describing Field Type 3 a key indicates the field type number of the next field for each message. On subsequent field pages, the field type number of the previous field is shown to permit back reference also. The Start-of-ATS-Data Signal ‘(’ is used in the key to indicate that there is no previous type of field; the End-of-ATS-Data Signal ‘)’ is used to indicate that there is no next type of field.

1.7.4 On the field pages,

elements with a fixed number of characters are shown diagrammatically as (three characters in this example)

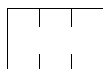

elements of variable length are shown as

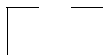

1.8 Accuracy in the preparation of ATS messages

Where the standard ATS messages are transmitted by teletypewriter channels in areas where ATC computers are known to be in use, the formats and data conventions prescribed in the field tables on pages A3-6 to A3-34 shall be adhered to rigorously.

Field Type 3 — Message type, number and reference data

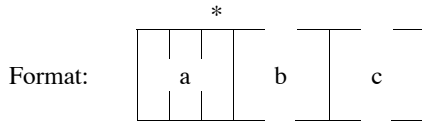

OPEN BRACKET

(a) *Message type designator*

3 LETTERS as follows:

ALR	Alerting
RCF	Radiocommunication failure
FPL	Filed flight plan
CHG	Modification
CNL	Cancellation
DLA	Delay
DEP	Departure
ARR	Arrival
CPL	Current flight plan
EST	Estimate
CDN	Coordination
ACP	Acceptance
LAM	Logical acknowledgement
RQP	Request flight plan
RQS	Request supplementary flight plan
SPL	Supplementary flight plan

* Unless instructed otherwise, this field shall contain only the single element (a). Elements (b) or (b) and (c) are for use when messages are generated by, and/or exchanged between, the computer systems of ATS units.

(b) *Message number*

1 to 4 LETTER(S)	identifying the sending ATS unit, followed by
OBLIQUE STROKE (/)	followed by
1 to 4 LETTER(S)	identifying the receiving ATS unit, followed by
3 DECIMAL NUMERICS	giving the serial number of this message in the sequence of messages transmitted by this unit to the indicated receiving ATS unit.

FIELD TYPE 3

<i>Previous type of field or symbol</i>	<i>This type of field is used in</i>	<i>Next type of field or symbol</i>
(ALR	5
(RCF	7
(FPL	7
(CHG	7
(CNL	7
(DLA	7
(DEP	7
(ARR	7
(CPL	7
(EST	7
(CDN	7
(ACP	7
(LAM)
(RQP	7
(RQS	7
(SPL	7

*Field Type 3 (cont.)**(c) Reference data*

1 to 4 LETTER(S) followed by OBLIQUE STROKE (/) followed by 1 to 4 LETTER(S) followed by 3 DECIMAL NUMERICS, giving the “message number” contained in element (b) of the operational message which began the sequence of messages of which this message is a part.

Examples: (FPL
(CNL
(CHGA/B234A/B231
(CPLA/B002

Field Type 5 — Description of emergency

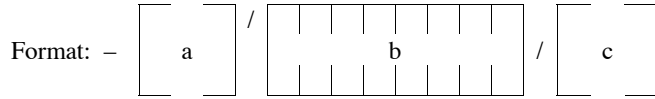

FIELD TYPE 5

SINGLE HYPHEN

<p>(a) <i>Phase of emergency</i></p> <p>or INCERFA if an uncertainty phase, or ALERFA if an alert phase, DETRESFA if a distress phase</p> <p>has been declared in respect of the aircraft concerned.</p>
--

<i>Previous type of field or symbol</i>	<i>This type of field is used in</i>	<i>Next type of field or symbol</i>
3	ALR	7

OBLIQUE STROKE

<p>(b) <i>Originator of message</i></p> <p>8 LETTERS, being the 4-letter ICAO location indicator plus the 3-letter designator of the ATS unit originating the message followed by the letter X or, if applicable, the one-letter designator identifying the division of the ATS unit originating the message.</p>

OBLIQUE STROKE

<p>(c) <i>Nature of emergency</i></p> <p>SHORT PLAIN-LANGUAGE TEXT, as necessary to explain the nature of the emergency, with natural spaces between the words.</p>

Example: –ALERFA/EINNZQZX/REPORT OVERDUE

Field Type 7 — Aircraft identification and SSR mode and code

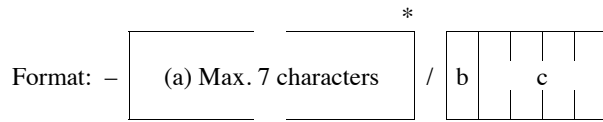

SINGLE HYPHEN

(a) *Aircraft identification*

NOT MORE THAN 7 CHARACTERS, being the aircraft identification shown in the filed flight plan and composed as specified in Appendix 2, Section 2.

* This field may be terminated here in messages relating to flights operating within areas where SSR is not used, or when the SSR code information is not known or would not be meaningful to the accepting unit.

OBLIQUE STROKE

(b) *SSR mode*

LETTER A giving the SSR mode related to (c).

(c) *SSR code*

4 NUMERICS giving the SSR code assigned to the aircraft by ATS and transmitted in the mode given in (b).

Examples: —BAW902
—SAS912/A5100

FIELD TYPE 7

<i>Previous type of field or symbol</i>	<i>This type of field is used in</i>	<i>Next type of field or symbol</i>
5 3	ALR RCF	8 21
3 3 3 3 3 3	FPL CHG CNL DLA DEP ARR	8 13 13 13 13 13
3 3 3 3	CPL EST CDN ACP	8 13 13 13
3 3 3	RQP RQS SPL	13 13 13

Field Type 8 — Flight rules and type of flight

Format: —

*
a b

SINGLE HYPHEN

(a) *Flight rules*

1 LETTER as follows:

I if it is intended that the entire flight will be operated under the IFR
 V if it is intended that the entire flight will be operated under the VFR
 Y if the flight initially will be operated under the IFR, followed by one or more subsequent changes of flight rules
 Z if the flight initially will be operated under the VFR, followed by one or more subsequent changes of flight rules

Note.— If the letter Y or Z is used, the point or points at which a change of flight rules is planned is to be shown as indicated in Field Type 15.

* This field shall be terminated here unless indication of the type of flight is required by the appropriate ATS authority.

(b) *Type of flight*

1 LETTER as follows:

S if scheduled air transport
 N if non-scheduled air transport
 G if general aviation
 M if military
 X other flights

Examples: —V
 —IS

FIELD TYPE 8

<i>Previous type of field or symbol</i>	<i>This type of field is used in</i>	<i>Next type of field or symbol</i>
7	ALR	9
7	FPL	9
7	CPL	9

Field Type 9 — Number and type of aircraft and wake turbulence category

FIELD TYPE 9

Format: —

a	b
---	---

 /

c

Previous type of field or symbol	This type of field is used in	Next type of field or symbol
8	ALR	10
8	FPL	10
8	CPL	10

SINGLE HYPHEN

(a) *Number of aircraft (if more than one)*

Note.— This element is included only in the case of formation flights.

1 OR 2 NUMERICS giving the number of aircraft in the flight.

(b) *Type of aircraft*

2 to 4 CHARACTERS, being the appropriate designator chosen from ICAO Doc 8643, *Aircraft Type Designators*, or

ZZZZ if no designator has been assigned or if there is more than one type of aircraft in the flight.

Note.— If the letters ZZZZ are used, the type(s) of aircraft is (are) to be shown in the Other Information Field (see Field Type 18).

OBLIQUE STROKE

(c) *Wake turbulence category*

1 LETTER to indicate maximum certificated take-off mass of the aircraft:

H — Heavy
M — Medium
L — Light

Examples: —DC3/M
—B707/M
—2FK27/M
—ZZZZ/L
—3ZZZZ/L
—B747/H

Field Type 10 — Equipment and capabilities

FIELD TYPE 10

Format: —

a

 /

b

SINGLE HYPHEN

Previous type of field or symbol	This type of field is used in	Next type of field or symbol
9	ALR	13
9	FPL	13
9	CPL	13

(a) *Radiocommunication, navigation and approach aid equipment and capabilities*

1 LETTER as follows:

N no COM/NAV/approach aid equipment for the route to be flown is carried, or the equipment is unserviceable

OR S Standard COM/NAV/approach aid equipment for the route to be flown is carried and serviceable (*see Note 1*)

AND/OR ONE OR MORE OF THE FOLLOWING LETTERS to indicate the serviceable COM/NAV/approach aid equipment and capabilities

A	GBAS landing system	J7	CPDLC FANS 1/A
B	LPV (APV with SBAS)		SATCOM (Iridium)
C	LORAN C	K	MLS
D	DME	L	ILS
E1	FMC WPR ACARS	M1	ATC SATVOICE
E2	D-FIS ACARS		(INMARSAT)
E3	PDC ACARS	M2	ATC SATVOICE (MTSAT)
F	ADF	M3	ATC SATVOICE (Iridium)
G	GNSS. If any portion of the flight is planned to be conducted under IFR, it refers to GNSS receivers that comply with the requirements of Annex 10, Volume I (<i>See Note 2</i>)	O	VOR
		P1	CPDLC RCP 400 (<i>see Note 7</i>)
		P2	CPDLC RCP 240 (<i>see Note 7</i>)
		P3	SATVOICE RCP 400 (<i>see Note 7</i>)
		P4–P9	Reserved for RCP
H	HF RTF	R	PBN approved (<i>see Note 4</i>)
I	Inertial navigation	T	TACAN
J1	CPDLC ATN VDL Mode 2 (<i>see Note 3</i>)	U	UHF RTF
		V	VHF RTF
J2	CPDLC FANS 1/A HFDL	W	RVSM approved
J3	CPDLC FANS 1/A VDL Mode A	X	MNPS approved
J4	CPDLC FANS 1/A VDL Mode 2	Y	VHF with 8.33 kHz channel spacing capability
J5	CPDLC FANS 1/A SATCOM (INMARSAT)	Z	Other equipment carried or other capabilities (<i>see Note 5</i>)
J6	CPDLC FANS 1/A SATCOM (MTSAT)		

Note 1.— If the letter S is used, standard equipment is considered to be VHF RTF, VOR and ILS, unless another combination is prescribed by the appropriate ATS authority.

Note 2.— If the letter G is used, the types of external GNSS augmentation, if any, are specified in Item 18 following the indicator NAV/ separated by a space.

Note 3.— See RTCA/EUROCAE Interoperability Requirements Standard for ATN Baseline 1 (ATN B1 INTEROP Standard – DO-280B/ED-110B) for data link services air traffic control clearance and information/air traffic control communications management/air traffic control microphone check.

Note 4.— If the letter R is used, the performance-based navigation levels that can be met are specified in Item 18 following the indicator PBN/. Guidance material on the application of performance-based navigation to a specific route segment, route or area is contained in the Performance-based Navigation (PBN) Manual (Doc 9613).

Field Type 10 (cont.)

Note 5.— If the letter Z is used, specify in Item 18 the other equipment carried or other capabilities, preceded by COM/, NAV/ and/or DAT, as appropriate.

Note 6.— Information on navigation capability is provided to ATC for clearance and routing purposes.

Note 7.— Guidance material on the application of performance-based communication, which prescribes RCP to an air traffic service in a specific area, is contained in the Performance-based Communication and Surveillance (PBCS) Manual (Doc 9869).

OBLIQUE STROKE

(b) *Surveillance equipment and capabilities*

INSERT N if no surveillance equipment for the route to be flown is carried, or the equipment is unserviceable,

OR

ONE OR MORE of the following descriptors, to a maximum of 20 characters, to describe the serviceable surveillance equipment and/or capabilities on board:

SSR Modes A and C

A Transponder — Mode A (4 digits — 4 096 codes)

C Transponder — Mode A (4 digits — 4 096 codes) and Mode C

SSR Modes S

E Transponder — Mode S, including aircraft identification, pressure-altitude and extended squitter (ADS-B) capability

H Transponder — Mode S, including aircraft identification, pressure-altitude and enhanced surveillance capability

I Transponder — Mode S, including aircraft identification, but no pressure-altitude capability

L Transponder — Mode S, including aircraft identification, pressure-altitude, extended squitter (ADS-B) and enhanced surveillance capability

P Transponder — Mode S, including pressure-altitude, but no aircraft identification capability

S Transponder — Mode S, including both pressure-altitude and aircraft identification capability

X Transponder — Mode S with neither aircraft identification nor pressure-altitude capability

Note.— Enhanced surveillance capability is the ability of the aircraft to down-link aircraft derived data via a Mode S transponder.

ADS-B

B1 ADS-B with dedicated 1 090 MHz ADS-B “out” capability

B2 ADS-B with dedicated 1 090 MHz ADS-B “out” and “in” capability

U1 ADS-B “out” capability using UAT

U2 ADS-B “out” and “in” capability using UAT

V1 ADS-B “out” capability using VDL Mode 4

V2 ADS-B “out” and “in” capability using VDL Mode 4

Field Type 10 (cont.)

ADS-C

D1 ADS-C with FANS 1/A capabilities

G1 ADS-C with ATN capabilities

Alphanumeric characters not indicated above are reserved.

Note 1.— The RSP specification(s), if applicable, will be listed in Item 18 following the indicator SUR/. Guidance material on the application of performance-based surveillance, which prescribes RSP to an air traffic service in a specific area, is contained in the Performance-based Communication and Surveillance (PBCS) Manual (Doc 9869).

Note 2.— Additional surveillance equipment or capabilities will be listed in Item 18 following the indicator SUR/, as required by the appropriate authority.

Examples: –S/A
 –SCI/CB1
 –SAFR/SV1

Field Type 13 — Departure aerodrome and time

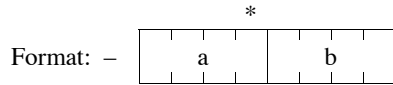

SINGLE HYPHEN

(a) *Departure aerodrome*

4 LETTERS, being

the ICAO four-letter location indicator allocated to the departure aerodrome, as specified in Doc 7910, *Location Indicators*, or

ZZZZ if no ICAO location indicator has been allocated (*see Note 1*) or if the departure aerodrome is not known, or

AFIL if the flight plan has been filed in the air (*see Note 2*).

Note 1.— If ZZZZ is used, the name and location of the departure aerodrome is to be shown in the Other Information Field (see Field Type 18) if this Field Type is contained in the message.

Note 2.— If AFIL is used, the ATS unit from which supplementary flight data can be obtained is to be shown in the Other Information Field (Field Type 18).

* This field shall be terminated here in message types CPL, EST, CDN and ACP. It shall be terminated here in message type RQP if the estimated off-block time is not known.

(b) *Time*

4 NUMERICS giving

the estimated off-block time (EOBT) at the aerodrome in (a) in FPL, ARR, CHG, CNL, DLA and RQS messages and in RQP message, if known, or

the actual time of departure from the aerodrome in (a) in ALR, DEP and SPL messages, or

the actual or estimated time of departure from the first point shown in the Route Field (see Field Type 15) in FPL messages derived from flight plans filed in the air, as shown by the letters AFIL in (a).

Examples: —EHAM0730
 —AFIL1625

FIELD TYPE 13

Previous type of field or symbol	This type of field is used in	Next type of field or symbol
10	ALR	15
10	FPL	15
7	CHG	16
7	CNL	16
7	DLA	16
7	DEP	16
7	ARR	(16)** 17
10	CPL	14
7	EST	14
7	CDN	16
7	ACP	16
7	RQP	16
7	RQS	16
7	SPL	16

** Only in case of a diversionary landing

Field Type 14 — Estimate data

FIELD TYPE 14

Format: —

a

 /

b	c	d	e
---	---	---	---

 *

Previous type of field or symbol	This type of field is used in	Next type of field or symbol
13	CPL	15
13	EST	16

SINGLE HYPHEN

(a) *Boundary point (see Note 1)*

The BOUNDARY POINT expressed either by a designator consisting of 2 to 5 characters, in geographical coordinates, in abbreviated geographical coordinates, or by bearing and distance from a significant point.

Note 1.— This point may be an agreed point located close to, rather than on, the FIR boundary.

Note 2.— See 1.6 for data conventions.

OBLIQUE STROKE

(b) *Time at boundary point*

4 NUMERICS giving the estimated time at the boundary point.

(c) *Cleared level*

- F followed by 3 NUMERICS, or
- S followed by 4 NUMERICS, or
- A followed by 3 NUMERICS, or
- M followed by 4 NUMERICS

} See data conventions in 1.6 of this Appendix.

giving the cleared level at which the aircraft will cross the boundary point, if in level cruising flight, or the cleared level to which it is proceeding, if climbing or descending at the boundary point.

* This field will be terminated here if the aircraft will cross the boundary point in level cruising flight.

Field Type 14 (cont.)

(d) *Supplementary crossing data*

A LEVEL, expressed as in (c), at or above which or at or below which (see (e)) the aircraft will cross the boundary point.

(e) *Crossing condition*

1 LETTER as follows:

A if the aircraft will cross the boundary point at or above the level in (d),
or

B if the aircraft will cross the boundary point at or below the level in (d).

Examples: -LN/1746F160
-CLN/1831F240F180A
-5420N05000W/0417F290
-LNX/1205F160F200B
-ZD126028/0653F130

Field Type 15 — Route

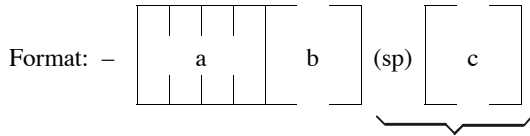

See Note in margin.

FIELD TYPE 15

Previous type of field or symbol	This type of field is used in	Next type of field or symbol
13	ALR	16
13	FPL	16
14	CPL	16

SINGLE HYPHEN

(a) *Cruising speed or Mach number*

The true airspeed for the first or the whole cruising portion of the flight, in terms of:

K followed by 4 NUMERICS giving the true airspeed in kilometres per hour, or

N followed by 4 NUMERICS giving the true airspeed in knots, or

when so prescribed by the appropriate ATS authority, M followed by 3 NUMERICS giving the true Mach number to the nearest hundredth of unit Mach.

(b) *Requested cruising level*

F followed by 3 NUMERICS, or

S followed by 4 NUMERICS, or

A followed by 3 NUMERICS, or

M followed by 4 NUMERICS, or

VFR.

} See data conventions in 1.6 of this Appendix.

SPACE

followed by a string of elements/groups of elements of the following seven types separated by SPACES, in whatever sequence is necessary to describe the route in an unambiguous manner (see Appendix 2, Section 2).

Note.— Further element groups of elements (c) should be added, as necessary, each to be preceded by a space.

*Field Type 15 (cont.)**(c1) Standard departure route*

The designator for the standard departure route from the aerodrome of departure to the first significant point on the defined route to be flown.

Note 1.— See data convention in 1.6.3 a) of this Appendix.

Note 2.— Element (c1) may be followed by (c3) or (c4).

Note 3.— Standard departure route need be included only where appropriate.

(c2) ATS route designator

Note 1.— See data convention in 1.6.3 a) of this Appendix.

Note 2.— Element (c2) may be followed by (c3) or (c4) only.

(c3) Significant point

Note.— See alternative data conventions in 1.6.3 b), c), d) and e) of this Appendix.

(c4) Significant point/cruising speed and cruising level

SIGNIFICANT POINT (as in element (c3))

OBLIQUE STROKE

CRUISING SPEED OR MACH NUMBER (as in element (a))

REQUESTED CRUISING LEVEL (as in element (b)).

Field Type 15 (cont.)

(c5) *Indicator*

VFR	if a change to VFR is to be made at the preceding point, or
IFR	if a change to IFR is to be made at the preceding point, or
DCT	if the flight to the next point will be outside a designated route, unless both points are defined by geographical coordinates or by bearing and distance.
T	if the route description is truncated at the preceding point and the remainder is to be sought in a previously transmitted FPL or other data.

Note 1.— Element (c5) may follow (c3) or (c4) and (c6) only.

Note 2.— When used, T must conclude the Route Field.

(c6) *Cruise climb*

The letter C followed by an oblique stroke; then the point at which cruise climb is planned to start, expressed exactly as in (c3) above, followed by an oblique stroke; then the speed to be maintained during cruise climb expressed exactly as in (a) above followed by *the two levels* defining the layer to be occupied during cruise climb; each level expressed as in (b) above, or the level above which cruise climb is planned, followed by the letters PLUS, without a space between them.

(c7) *Standard arrival route*

The designator for the standard arrival route from the point of leaving the defined route to the point at which the approach procedure is initiated.

Note.— Standard arrival route need only be included where appropriate.

Examples: -K0410S1500 A4 CCV R11
 -K0290A120 BR 614
 -N0460F290 LEK2B LEK UA6 FNE UA6 XMM/M078F330 UA6N PON UR10N
 CHW UA5 NTS DCT 4611N00412W DCT STG UA5 FTM FATIM1A
 -M082F310 BCN1G BCN UG1 52N015W 52N020W 52N030W 50N040W
 49N050W DCT YQX
 -N0420F310 R10 UB19 CGC UA25 DIN/N0420F330 UR14 IBY UR1 MID

Field Type 16 — Destination aerodrome and total estimated elapsed time, destination alternate aerodrome(s)

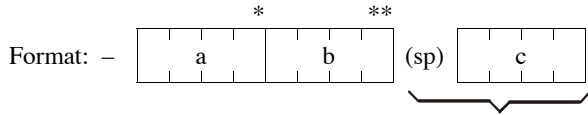

See Note in margin on page A3-22.

SINGLE HYPHEN

(a) *Destination aerodrome*

4 LETTERS, being

the ICAO four-letter location indicator allocated to the destination aerodrome, as specified in Doc 7910, *Location Indicators*, or

ZZZZ if no ICAO location indicator has been allocated.

Note.— If ZZZZ is used, the name and location of the destination aerodrome is to be shown in the Other Information Field (see Field Type 18).

* This field is to be terminated here in all message types other than ALR, FPL and SPL.

(b) *Total estimated elapsed time*

4 NUMERICS, giving

the total estimated elapsed time.

** This field may be terminated here in FPL messages when so agreed between the ATS units concerned or prescribed on the basis of regional air navigation agreements.

FIELD TYPE 16

Previous type of field or symbol	This type of field is used in	Next type of field or symbol
15	ALR	18
15	FPL	18
13	CHG	18
13	CNL	18
13	DLA	18
13	DEP	18
13	ARR***	17
15	CPL	18
14	EST)
13	CDN	22
13	ACP)
13	RQP	18
13	RQS	18
13	SPL	18

*** Only in case of a diversionary landing

Field Type 16 (cont.)

SPACE

(c) *Destination alternate aerodrome(s)*

4 LETTERS, being

the ICAO four-letter location indicator allocated to an alternate aerodrome, as specified in Doc 7910, *Location Indicators*, or

ZZZZ if no ICAO location indicator has been allocated.

Note.— If ZZZZ is used, the name and location of the destination alternate aerodrome is to be shown in the Other Information Field (see Field Type 18).

Note.— One further element of (c) should be added, as necessary, preceded by a space.

Examples: -EINN0630
 -EHAM0645 EBBR
 -EHAM0645 EBBR EDDL

Field Type 17 — Arrival aerodrome and time

Format: –

	a			b		
--	---	--	--	---	--	--

 (sp)

	c	
--	---	--

SINGLE HYPHEN

(a) *Arrival aerodrome*
 4 LETTERS, being
 the ICAO four-letter location indicator allocated to the arrival aerodrome, as specified in Doc 7910, *Location Indicators*, or
 ZZZZ if no ICAO location indicator has been allocated.

(b) *Time of arrival*
 4 NUMERICS, giving
 the actual time of arrival.

* This field is to be terminated here if an ICAO location indicator has been allocated to the arrival aerodrome.

SPACE

(c) *Arrival aerodrome*
 Name of arrival aerodrome, if ZZZZ is inserted in (a).

Examples: –EHAM1433
 –ZZZZ1620 DEN HELDER

FIELD TYPE 17

<i>Previous type of field or symbol</i>	<i>This type of field is used in</i>	<i>Next type of field or symbol</i>
13 (16)**	ARR)

** Only in case of a diversionary landing

Field Type 18 — Other information

FIELD TYPE 18

Note.— Use of indicators not included under this item may result in data being rejected, processed incorrectly or lost.

Hyphens or oblique strokes should only be used as prescribed below.

Format: –

A

–

or

--	--

 (sp)

--	--

 (sp) * (sp)

--	--

 (* additional elements as necessary)

Previous type of field or symbol	This type of field is used in	Next type of field or symbol
16	ALR	19
16	FPL)
16	CPL)
16	SPL	19

SINGLE HYPHEN

(a)	0 (zero) if no other information
-----	----------------------------------

OR

Any other necessary information in the sequence shown hereunder, in the form of the appropriate abbreviation selected from those defined hereunder followed by an oblique stroke and the information to be recorded:

STs/	Reason for special handling by ATS, e.g. a search and rescue mission, as follows: ALTRV: for a flight operated in accordance with an altitude reservation; ATFMX: for a flight approved for exemption from ATFM measures by the appropriate ATS authority; FFR: fire-fighting; FLTCK: flight check for calibration of nav aids; HAZMAT: for a flight carrying hazardous material; HEAD: a flight with Head of State status; HOSP: for a medical flight declared by medical authorities; HUM: for a flight operating on a humanitarian mission; MARSAs: for a flight for which a military entity assumes responsibility for separation of military aircraft; MEDEVAC: for a life critical medical emergency evacuation; NONRVSM: for a non-RVSM capable flight intending to operate in RVSM airspace; SAR: for a flight engaged in a search and rescue mission; and STATE: for a flight engaged in military, customs or police services.
	Other reasons for special handling by ATS shall be denoted under the designator RMK/.
PBN/	Indication of RNAV and/or RNP capabilities. Include as many of the descriptors below, as apply to the flight, up to a maximum of 8 entries, i.e. a total of not more than 16 characters.

Field Type 18 (cont.)

RNAV SPECIFICATIONS	
A1	RNAV 10 (RNP 10)
B1	RNAV 5 all permitted sensors
B2	RNAV 5 GNSS
B3	RNAV 5 DME/DME
B4	RNAV 5 VOR/DME
B5	RNAV 5 INS or IRS
B6	RNAV 5 LORANC
C1	RNAV 2 all permitted sensors
C2	RNAV 2 GNSS
C3	RNAV 2 DME/DME
C4	RNAV 2 DME/DME/IRU
D1	RNAV 1 all permitted sensors
D2	RNAV 1 GNSS
D3	RNAV 1 DME/DME
D4	RNAV 1 DME/DME/IRU
RNP SPECIFICATIONS	
L1	RNP 4
O1	Basic RNP 1 all permitted sensors
O2	Basic RNP 1 GNSS
O3	Basic RNP 1 DME/DME
O4	Basic RNP 1 DME/DME/IRU
S1	RNP APCH
S2	RNP APCH with BAR-VNAV
T1	RNP AR APCH with RF (special authorization required)
T2	RNP AR APCH without RF (special authorization required)

Combinations of alphanumeric characters not indicated above are reserved.

NAV/ Significant data related to navigation equipment, other than specified in PBN/, as required by the appropriate ATS authority. Indicate GNSS augmentation under this indicator, with a space between two or more methods of augmentation, e.g. NAV/GBAS SBAS.

COM/ Indicate communication equipment and capabilities not specified in Item 10 a).

DAT/ Indicate data communication equipment and capabilities not specified in 10 a).

SUR/ Indicate surveillance equipment and capabilities not specified in Item 10 b). Indicate as many RSP specification(s) as apply to the flight, using designator(s) with no space. Multiple RSP specifications are separated by a space. Example: RSP180 RSP400.

Field Type 18 (cont.)

DEP/ Name and location of departure aerodrome, if ZZZZ is inserted in Item 13, or the ATS unit from which supplementary flight plan data can be obtained, if AFIL is inserted in Item 13. For aerodromes not listed in the relevant Aeronautical Information Publication, indicate location as follows:

With 4 figures describing latitude in degrees and tens and units of minutes followed by "N" (North) or "S" (South), followed by 5 figures describing longitude in degrees and tens and units of minutes, followed by "E" (East) or "W" (West). Make up the correct number of figures, where necessary, by insertion of zeros, e.g. 4620N07805W (11 characters).

OR Bearing and distance from the nearest significant point, as follows:

The identification of the significant point followed by the bearing from the point in the form of 3 figures giving degrees magnetic, followed by the distance from the point in the form of 3 figures expressing nautical miles. In areas of high latitude where it is determined by the appropriate authority that reference to degrees magnetic is impractical, degrees true may be used. Make up the correct number of figures, where necessary, by insertion of zeros, e.g. a point of 180° magnetic at a distance of 40 nautical miles from VOR "DUB" should be expressed as DUB180040.

OR The first point of the route (name or LAT/LONG) or the marker radio beacon, if the aircraft has not taken off from an aerodrome.

DEST/ Name and location of destination aerodrome, if ZZZZ is inserted in Item 16. For aerodromes not listed in the relevant Aeronautical Information Publication, indicate location in LAT/LONG or bearing and distance from the nearest significant point, as described under DEP/ above.

DOF/ The date of flight departure in a six-figure format (YYMMDD, where YY equals the year, MM equals the month and DD equals the day).

REG/ The nationality or common mark and registration mark of the aircraft, if different from the aircraft identification in Item 7.

EET/ Significant points or FIR boundary designators and accumulated estimated elapsed times from take-off to such points or FIR boundaries, when so prescribed on the basis of regional air navigation agreements, or by the appropriate ATS authority.

Examples: -EET/CAP0745 XYZ0830
-EET/EINN0204

SEL/ SELCAL Code, for aircraft so equipped.

Field Type 18 (cont.)

TYP/	Type(s) of aircraft preceded if necessary without a space by number(s) of aircraft and separated by one space if ZZZZ is inserted in Item 9. Example: –TYP/2F15 5F5 3B2
------	--

CODE/	Aircraft address (expressed in the form of an alphanumeric code of six hexadecimal characters) when required by the appropriate ATS authority. Example: “F00001” is the lowest aircraft address contained in the specific block administered by ICAO.
-------	--

Field Type 18 (cont.)

DLE/	En-route delay or holding, insert the significant point(s) on the route where a delay is planned to occur, followed by the length of delay using four-figure time in hours and minutes (hhmm). Example: –DLE/MDG0030
------	---

OPR/	ICAO designator or name of the aircraft operating agency, if different from the aircraft identification in item 7.
------	--

ORGN/	The originator’s eight-letter AFTN address or other appropriate contact details, in cases where the originator of the flight plan may not be readily identified, as required by the appropriate ATS authority. <i>Note.— In some areas, flight plan reception centres may insert the ORGN/ identifier and originator’s AFTN address automatically.</i>
-------	---

PER/	Aircraft performance data, indicated by a single letter as specified in the <i>Procedures for Air Navigation Services — Aircraft Operations</i> (PANS-OPS, Doc 8168), <i>Volume I — Flight Procedures</i> , if so prescribed by the appropriate ATS authority.
------	--

ALTN/	Name of destination alternate aerodrome(s), if ZZZZ is inserted in Item 16. For aerodromes not listed in the relevant Aeronautical Information Publication, indicate location in LAT/LONG or bearing and distance from the nearest significant point, as described in DEP/ above.
-------	---

RALT/	ICAO four-letter indicator(s) for en-route alternate(s), as specified in Doc 7910, <i>Location Indicators</i> , or name(s) of en-route alternate aerodrome(s), if no indicator is allocated. For aerodromes not listed in the relevant Aeronautical Information Publication, indicate location in LAT/LONG or bearing and distance from the nearest significant point, as described in DEP/ above.
-------	--

TALT/	ICAO four-letter indicator(s) for take-off alternate, as specified in Doc 7910, <i>Location Indicators</i> , or name of take-off alternate aerodrome, if no indicator is allocated. For aerodromes not listed in the relevant Aeronautical Information Publication, indicate location in LAT/LONG or bearing and distance from the nearest significant point, as described in DEP/ above.
-------	---

Field Type 18 (cont.)

RIF/ The route details to the revised destination aerodrome, followed by the ICAO four-letter location indicator of the aerodrome. The revised route is subject to reclearance in flight.

Examples: -RIF/DTA HEC KLAX
-RIF/ESP G94 CLA YPPH

RMK/ Any other plain-language remarks when required by the appropriate ATS authority or deemed necessary, by the pilot-in-command for the provision of air traffic services.

Examples: -0
-STS/MEDEVAC
-EET/015W0315 020W0337 030W0420 040W0502

Field Type 19 — Supplementary information

FIELD TYPE 19

Format: — [] (sp) [] (sp) * (sp) []
 (* additional elements as necessary)

<i>Previous type of field or symbol</i>	<i>This type of field is used in</i>	<i>Next type of field or symbol</i>
18	ALR	20
18	SPL)

This field consists of such supplementary information as is available, organized into a string of elements separated by spaces.

The permissible elements in their proper sequence are:

SINGLE HYPHEN

- | | | |
|-----|----|--|
| (a) | E/ | followed by 4 NUMERICS giving the fuel endurance in hours and minutes. |
| (b) | P/ | followed by 1, 2 or 3 NUMERICS giving the total number of persons on board, when so prescribed by the appropriate ATS authority. |
| (c) | R/ | followed by one or more of the following, without spaces:

U if frequency 243.0 MHz (UHF) is available,
V if frequency 121.5 MHz (VHF) is available,
E if emergency locator transmitter (ELT) is available. |
| (d) | S/ | followed by one or more of the following, without spaces:

P if polar survival equipment is carried,
D if desert survival equipment is carried,
M if maritime survival equipment is carried,
J if jungle survival equipment is carried. |
| (e) | J/ | followed by one or more of the following, without spaces:

L if the life jackets are equipped with lights,
F if they are equipped with fluorescein, followed by space followed by
U if any life jacket radio is equipped with UHF on frequency 243.0 MHz,
V if any life jacket radio is equipped with VHF on frequency 121.5 MHz. |

Field Type 19 (cont.)

(f) D/ followed by one or more of the following, separated by spaces:
2 NUMERICS giving the number of dinghies carried,
3 NUMERICS giving the total capacity, in persons carried, of all dinghies.
C if dinghies are covered.
The colour of the dinghies (e.g. RED).

(g) A/ followed by one or more of the following, separated by spaces:
The colour of the aircraft.
Significant markings (this may include the aircraft registration).

(h) N/ followed by plain language indicating any other survival equipment carried and any other useful remarks.

(i) C/ followed by the name of the pilot-in-command.

Example: -E/0745 P/6 R/VE S/M J/L D/2 8 C YELLOW
A/YELLOW RED TAIL N145E C/SMITH

Field Type 20 — Alerting search and rescue information

FIELD TYPE 20

Format: – [] (sp) [] (sp) * (sp) []
 (*EIGHT elements in all)

<i>Previous type of field or symbol</i>	<i>This type of field is used in</i>	<i>Next type of field or symbol</i>
19	ALR)

This field consists of the following specified sequence of elements separated by spaces. Any information not available should be shown as “NIL” or “NOT KNOWN” and not simply omitted.

SINGLE HYPHEN

- (a) *Identity of operator*
 The ICAO two-letter designator of the aircraft operating agency or, if this has not been assigned, the name of the operator.
- (b) *Unit which made last contact*
 6 LETTERS consisting of the 4-letter ICAO location indicator followed by the 2-letter designator which together identify the ATS unit which made the last two-way contact or, if these are not available, some other description of the unit.
- (c) *Time of last two-way contact*
 4 NUMERICS giving the time of the last two-way contact.
- (d) *Frequency of last contact*
 NUMERICS as necessary giving the transmitting/receiving frequency of the last contact.
- (e) *Last reported position*
 The last reported position expressed in one of the data conventions of 1.6 of this Appendix followed by the time over that position.

Field Type 20 (cont.)

(f) *Method of determining last known position*

Plain-language text as necessary.

(g) *Action taken by reporting unit*

Plain-language text as necessary.

(h) *Other pertinent information*

Plain-language text as necessary.

Example: -USAF LGGGZAZX 1022 126.7 GN 1022
 PILOT REPORT OVER NDB ATS UNITS
 ATHENS FIR ALERTED NIL

Field Type 21 — Radio failure information

FIELD TYPE 21

Format: – [] (sp) [] (sp) * (sp) []
 (*SIX elements in all)

Previous type of field or symbol	This type of field is used in	Next type of field or symbol
7	RCF)

This field consists of the following specified sequence of elements preceded by a single hyphen and separated by spaces. Any information not available is to be shown as “NIL” or “NOT KNOWN” and not simply omitted.

SINGLE HYPHEN

- (a) *Time of last two-way contact*
4 NUMERICS giving the time of the last two-way contact with the aircraft.
- (b) *Frequency of last contact*
NUMERICS as necessary giving the transmitting/receiving frequency of the last two-way contact with the aircraft.
- (c) *Last reported position*
The last reported position expressed in one of the data conventions of 1.6 of this Appendix.
- (d) *Time at last reported position*
4 NUMERICS giving the time at the last reported position.
- (e) *Remaining COM capability*
LETTERS as necessary identifying the remaining COM capability of the aircraft, if known, using the convention of Field Type 10, or in plain language.
- (f) *Any necessary remarks*
Plain-language text as necessary.

Example: –1232 121.3 CLA 1229 TRANSMITTING ONLY 126.7
 LAST POSITION CONFIRMED BY RADAR

Field Type 22 — Amendment

Format: – a / b

SINGLE HYPHEN

(a) *Field indicator*
ONE OR TWO NUMERICS giving the type number of the field to be amended.

OBLIQUE STROKE

(b) *Amended data*
The complete and amended data of the field indicated in (a), constructed as specified for that field.

Example of amendment of Field Type 8 (Flight rules and type of flight) to IN:

–8/IN

Example of amendment of Field Type 14 (Estimate data):

–14/ENO/0145F290A090A

Example of amendment of Fields Type 8 (Flight rules and type of flight) and 14 (Estimate data):

–8/I-14/ENO/0148F290A110A

FIELD TYPE 22

<i>Previous type of field or symbol</i>	<i>This type of field is used in</i>	<i>Next type of field or symbol</i>
18	CHG	*22 or)
16	CDN	*22 or)

* Indicates that further fields of this type may be added

RULES FOR THE COMPOSITION OF ATS MESSAGES

(See Sections 1.3 to 1.8 of this Appendix)

STANDARD ATS MESSAGES AND THEIR COMPOSITION

DESIGNATOR	MESSAGE TYPE	MESSAGE FIELDS																						FIELD TYPE NUMBERS
		1	2	3	4	5	6	7	8	9	10	11	12	13	14	15	16	17	18	19	20	21	22	
Alerting	ALR			3	5		7	8	9	10				13		15	16		18	19	20			Emergency messages
Radiocommunication failure	RCF			3			7															21		Emergency messages
Filed flight plan	FPL			3			7	8	9	10				13		15	16		18					Field flight plan messages and associated update messages
Delay	DLA			3			7							13			16		18					
Modification	CHG			3			7							13			16		18				22	
Flight plan cancellation	CNL			3			7							13			16		18					
Departure	DEP			3			7							13			16		18					
Arrival	ARR			3			7							13			16	17						
Current flight plan	CPL			3			7	8	9	10				13	14	15	16		18					Coordination messages
Estimate	EST			3			7							13	14		16							
Coordination	CDN			3			7							13			16						22	
Acceptance	ACP			3			7							13			16							
Logical acknowledgement message	LAM			3																				
Request flight plan	RQP			3			7							13			16		18					Supplementary messages
Request supplementary flight plan	RQS			3			7							13			16		18					
Supplementary flight plan	SPL			3			7							13			16		18	19				

This field begins a new line when the message is printed in page teletypewriter form.

This field is repeated as necessary.

Composition of the standard types of message

The composition of each standard type of message, expressed as a standardized sequence of fields of data, shall be as prescribed in the reference table on this page. Each message shall contain all the fields prescribed.

Composition of the standard types of field

The composition of each standard type of field, expressed as a standardized sequence of elements of data, or in some cases as a simple element, shall be as prescribed in the field tables on pages A3-6 to A3-34.

Note.— Each type of field contains at least one mandatory element and, except in Field Type 9, this is the first or only element in the field. The rules for the inclusion or omission of conditional elements are indicated in the field tables.

Structuring and punctuation

The beginning of the ATS data shall be indicated on page copy by an open bracket ‘(’, which constitutes the Start-of-ATS-Data Signal. This signal shall be used only as the printed character immediately preceding the message type designator.

Note.— In teletypewriter operation using International Telegraph Alphabet No. 2, the open bracket is transmitted as the Figures Case of Signal No. 11. On some teletypewriter machines, this will print as a symbol other than ‘(’, but this variation will be local and of no consequence. Where higher level codes are employed, the character printing as ‘(’ is used.

The beginning of each field, other than the first, shall be indicated by a single hyphen ‘-’, which constitutes the Start-of-Field Signal. This signal shall be used only as the printed character preceding the first element of ATS data in each field.

Note.— In teletypewriter operation using International Telegraph Alphabet No. 2, the single hyphen is transmitted as the Figures Case of Signal No. 1. On some teletypewriter machines, this will print as a symbol other than ‘-’, but this variation will be local and of no consequence. Where higher level codes are employed, the character printing as ‘-’ is used.

Elements within a field shall be separated by an oblique stroke ‘/’ (see Note 1), or a space (sp.) (see Note 2) only where so prescribed in the field tables on pages A3-6 to A3-34.

Note 1.— In teletypewriter operation using International Telegraph Alphabet No. 2, the oblique stroke is transmitted as the Figures Case of Signal No. 24. On some teletypewriter machines, this will print as a symbol other than ‘/’, but this variation will be local and of no consequence. Where higher level codes are employed, the character printing as ‘/’ is used.

Note 2.— In teletypewriter operation using International Telegraph Alphabet No. 2, the space is transmitted as Signal No. 31. Where higher level codes are employed, the character which causes a space on page copy is to be used.

The end of the ATS data shall be indicated by a close bracket ‘)’, which constitutes the End-of-ATS-Data Signal. This signal shall be used only as the printed character immediately following the last field in the message.

Note.— In teletypewriter operation using International Telegraph Alphabet No. 2, the close bracket is transmitted as Signal No. 12. On some teletypewriter machines, this will print as a symbol other than ‘)’, but this variation will be local and of no consequence. Where higher level codes are employed, the character printing as ‘)’ is to be used.

When the standard ATS messages are prepared in teletypewriter form, an Alignment Function (two Carriage Returns followed by one Line Feed) shall be inserted:

- (a) prior to each of the fields so annotated in the reference table on this page;
- (b) in Fields Type 5 (Description of emergency), 15 (Route), 18 (Other information), 19 (Supplementary information), 20 (Alerting search and rescue information), 21 (Radio failure information) and 22 (Amendment), whenever it is necessary to begin a new line on page copy (see Note). In such cases, the Alignment Function shall be inserted between two data elements and shall not divide an element.

Note.— Annex 10, Volume II, prescribes that a line of teletypewriter copy shall not contain more than 69 characters.

Data conventions

Most of the conventions to be used in the expression of ATS data in the messages are prescribed in the field tables on pages A3-6 to A3-34, but the conventions for the expression of level, position and route data are given below.

The expression of level data

Four alternative conventions are available for the expression of level data:

- (a) ‘F’ followed by 3 decimal numerics: indicates a flight level number, i.e. Flight Level 340 is expressed as ‘F340’;
- (b) ‘S’ followed by 4 decimal numerics: indicates standard metric level in tens of metres, i.e. Standard Metric Level 11 300 m (Flight Level 370) is expressed as ‘S1130’;
- (c) ‘A’ followed by 3 decimal numerics: indicates altitude in hundreds of feet, i.e. an altitude of 4 500 feet is expressed as ‘A045’;
- (d) ‘M’ followed by 4 decimal numerics: indicates altitude in tens of metres, i.e. an altitude of 8 400 metres is expressed as ‘M0840’.

The expression of position or route

The following alternative data conventions shall be used for the expression of position or route:

- (a) from 2 to 7 characters, being the coded designator assigned to an ATS route to be flown;

- (b) from 2 to 5 characters, being the coded designator assigned to an en-route point;

- (c) 4 numerics describing latitude in degrees and tens and units of minutes, followed by ‘N’ (meaning ‘North’) or ‘S’ (South), followed by 5 numerics describing longitude in degrees and tens and units of minutes, followed by ‘E’ (East) or ‘W’ (West). The correct number of numerics is to be made up, where necessary, by the insertion of zeros, e.g. ‘4620N07805W’;

- (d) 2 numerics describing latitude in degrees, followed by ‘N’ (North) or ‘S’ (South), followed by 3 numerics describing longitude in degrees, followed by ‘E’ (East) or ‘W’ (West). Again, the correct number of numerics is to be made up, where necessary, by the insertion of zeros, e.g. ‘46N078W’;

- (e) 2 to 5 characters being the coded identification of a significant point, followed by 3 decimal numerics giving the bearing from the point in degrees magnetic followed by 3 decimal numerics giving the distance from the point in nautical miles. In areas of high latitude where it is determined by the appropriate authority that reference to degrees magnetic is impractical, degrees true may be used. The correct number of numerics is to be made up, where necessary, by the insertion of zeros, e.g. a point at 180° magnetic at a distance of 40 nautical miles from VOR ‘FOU’ would be expressed as ‘FOU180040’.

The detail of the fields

The elements of data prescribed or permitted to be included in each type of field, together with a prescription of the conditions or options permitted, are shown on pages A3-6 to A3-34.

A key appears at the right-hand side of each of the field pages; this key permits the sequence of fields in each type of message to be followed.

The first field in each message type is Field Type 3; on the page describing Field Type 3 a key indicates the field type number of the next field for each message. On subsequent field pages, the field type number of the previous field is shown to permit back reference also. The Start-of-ATS-Data Signal ‘(’ is used in the key to indicate that there is no previous type of field; the End-of-ATS-Data Signal ‘)’ is used to indicate that there is no next type of field.

On the field pages,

elements with a fixed number of characters are shown diagrammatically as (three characters in this example)

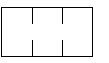

elements of variable length are shown as

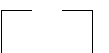

Accuracy in the preparation of ATS messages

Where the standard ATS messages are transmitted by teletypewriter channels in areas where ATC computers are known to be in use, the formats and data conventions prescribed in the field tables on pages A3-6 to A3-34 shall be adhered to rigorously.

2. Examples of ATS messages

2.1 Table of contents

<i>Message category</i>	<i>Message type</i>	<i>Message type designator</i>	<i>Paragraph</i>
Emergency	Alerting	ALR	2.2.1
	Radiocommunication failure	RCF	2.2.2
Filed flight plan and associated update	Filed flight plan	FPL	2.3.1
	Modification	CHG	2.3.2
	Cancellation	CNL	2.3.3
	Delay	DLA	2.3.4
	Departure	DEP	2.3.5
	Arrival	ARR	2.3.6
Coordination	Current flight plan	CPL	2.4.1
	Estimate	EST	2.4.2
	Coordination	CDN	2.4.3
	Acceptance	ACP	2.4.4
	Logical acknowledgement	LAM	2.4.5
Supplementary	Request flight plan	RQP	2.5.1
	Request supplementary flight plan	RQS	2.5.2
	Supplementary flight plan	SPL	2.5.3

Note 1.— Only the ATS information, i.e. in AFTN messages only the AFTN text, is shown.

Note 2.— The numbers in the composition diagrams correspond to the field type numbers used in Section 1 of this Appendix.

2.2 Emergency messages

2.2.1 Alerting (ALR) message

2.2.1.1 Composition

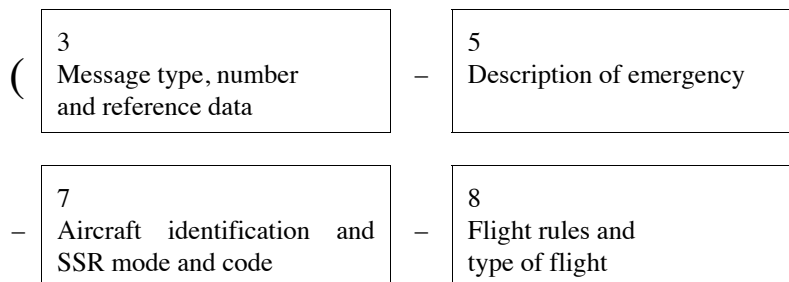

<p>9 Type of aircraft and wake turbulence category</p>	<p>10 Equipment and capabilities</p>
<p>13 Departure aerodrome and time</p>	
<p>15 Route (using more than one line if necessary)</p>	
<p>16 Destination aerodrome and total estimated elapsed time, destination alternate aerodrome(s)</p>	
<p>18 Other information (using more than one line if necessary)</p>	
<p>19 Supplementary information (using more than one line if necessary)</p>	
<p>20 Alerting search and rescue information (using more than one line if necessary)</p>	

2.2.1.2 Example

The following is an example of an alerting message relating to an uncertainty phase, sent by Athens Approach Control to Belgrade Centre and other ATS units, in respect of a flight from Athens to Munich.

```
(ALR-INCERFA/LGGGZAZX/OVERDUE
-FOX236/A3624-IM
-C141/H-S/C
-LGAT1020
-N0430F220 B9 3910N02230W/N0415F240 B9 IVA/N0415F180 B9
-EDDM0227 EDDF
```

–REG/A43213 EET/LYBE0020 EDMI0133 OPR/USAF RMK/NO
 POSITION REPORT SINCE DEP PLUS 2 MINUTES
 –E/0720 P/12 R/UV J/LF D/02 014 C ORANGE A/SILVER C/SIGGAH
 –USAF LGGGZAZX 1022 126.7 GN 1022 PILOT REPORT OVER NDB ATS
 UNITS ATHENS FIR ALERTED NIL)

2.2.1.2.1 Meaning

Alerting message — uncertainty phase declared by Athens due no position reports and no radio contact since two minutes after departure — aircraft identification FOX236 — IFR, military flight — Starlifter, heavy wake turbulence category, equipped with standard communications, navigation and approach aid equipment for the route, SSR transponder with Modes A (4 096 code capability) and C— last assigned Code 3624 — departed Athens 1020 UTC — cruising speed for first portion of route 430 knots, first requested cruising level FL 220 — proceeding on airway Blue 9 to 3910N2230W where TAS would be changed to 415 knots and FL240 would be requested — proceeding on airway Blue 9 to Ivanic Grad VOR where FL 180 would be requested, maintaining TAS of 415 knots and FL240 would be requested — proceeding on airway Blue 9 to Munich, total estimated elapsed time 2 hours and 27 minutes — destination alternate is Frankfurt — aircraft registration A43213 — accumulated estimated elapsed times at the Belgrade and Munich FIR boundaries 20 minutes and 1 hour and 33 minutes respectively — the aircraft is operated by the USAF — no position report has been received since 2 minutes after departure — endurance 7 hours and 20 minutes after take-off — 12 persons on board — portable radio equipment working on VHF 121.5 MHz and UHF 243 MHz is carried — life jackets fitted with lights and fluorescein are carried — 2 dinghies with orange covers are carried, have a total capacity for 14 persons — aircraft colour is silver — pilot's name is SIGGAH — operator is USAF — Athens approach control was the last unit to make contact at 1022 UTC on 126.7 MHz when pilot reported over GN runway locator beacon — Athens approach control have alerted all ATS units within Athens FIR — no other pertinent information.

2.2.2 Radiocommunication failure (RCF) message

2.2.2.1 Composition

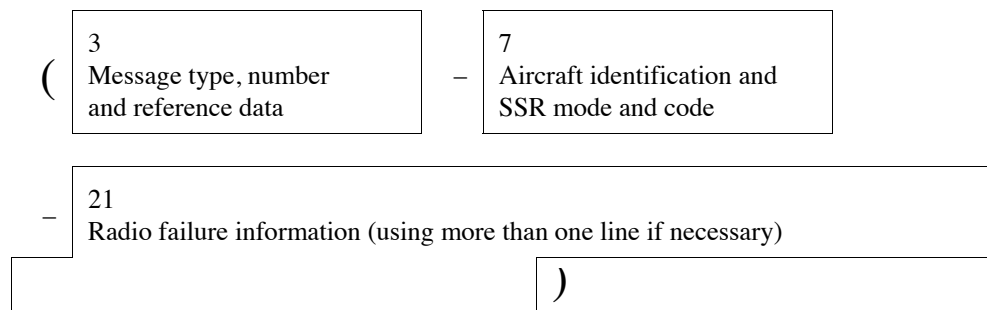

2.2.2.2 Example

The following is an example of a message sent from London to Amsterdam informing that centre of a radiocommunication failure on a flight that has been cleared to it. The related flight plan shows that the aircraft is not equipped with an SSR transponder.

(RCF-GAGAB
 –1231 121.3 CLA 1229 TRANSMITTING ONLY 126.7 MHZ LAST POSITION CONFIRMED BY RADAR)

2.2.2.2.1 *Meaning*

Radiocommunication failure message — aircraft identification GAGAB — no SSR code assigned — last communication with London Centre 1232 UTC on 121.3 MHz — last reported position was Clacton VOR, at 1229 UTC — remaining COM capability: last heard transmitting on 126.7 MHz — position report at Clacton observed by radar.

2.3 Filed flight plan and associated update messages

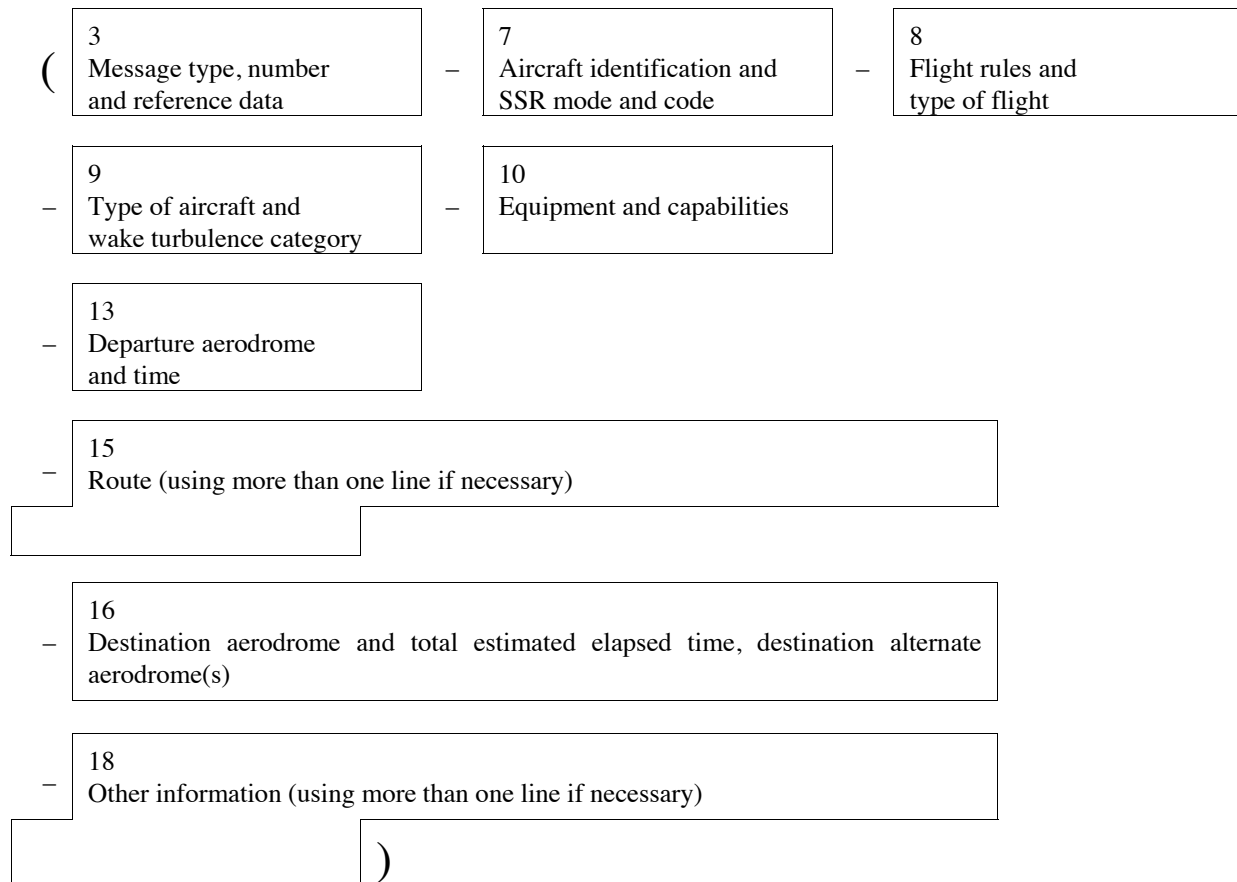
2.3.1 *Filed flight plan (FPL) message*2.3.1.1 *Composition*2.3.1.2 *Example*

The following is an example of a filed flight plan message sent by London Airport to Shannon, Shanwick and Gander Centres. The message may also be sent to the London Centre or the data may be passed to that centre by voice.

```
FPL-ACA101-IS
-B773/H-CHOV/C
-EGLL1400
-N0450F310 L9 UL9 STU285036/M082F310 UL9 LIMRI
52N020W 52N030W 50N040W 49N050W
-CYQX0455 CYRR
-EET/EISN0026 EGGX0111 020W0136 CYQX0228 040W0330 050W0415 SEL/FJEL)
```

2.3.1.2.1 *Meaning*

Filed flight plan message — aircraft identification ACA101 — IFR, scheduled flight — a Boeing 777-300, heavy wake turbulence category equipped with Loran C, HF RTF, VOR, VHF RTF and SSR transponder with Modes A (4 096 code capability) and C — departure aerodrome is London, estimated off-block time 1400 UTC — cruising speed and requested flight level for the first portion of the route are 450 knots and FL 310 — the flight will proceed on Airways Lima 9 and Upper Lima 9 to a point bearing 285 degrees magnetic and 36 NM from the Strumble VOR. From this point the flight will fly at a constant Mach number of .82, proceeding on Upper Lima 9 to LIMRI; then to 52N20W; to 52N30W; to 50N40W; to 49N50W; to destination Gander, total estimated elapsed time 4 hours and 55 minutes — destination alternate is Goose Bay — captain has notified accumulated estimated elapsed times at significant points along the route, they are at the Shannon FIR boundary 26 minutes, at the Shanwick Oceanic FIR boundary 1 hour and 11 minutes, at 20W 1 hour and 36 minutes, at the Gander Oceanic FIR boundary 2 hours and 28 minutes, at 40W 3 hours and 30 minutes and at 50W 4 hours and 15 minutes — SELCAL code is FJEL.

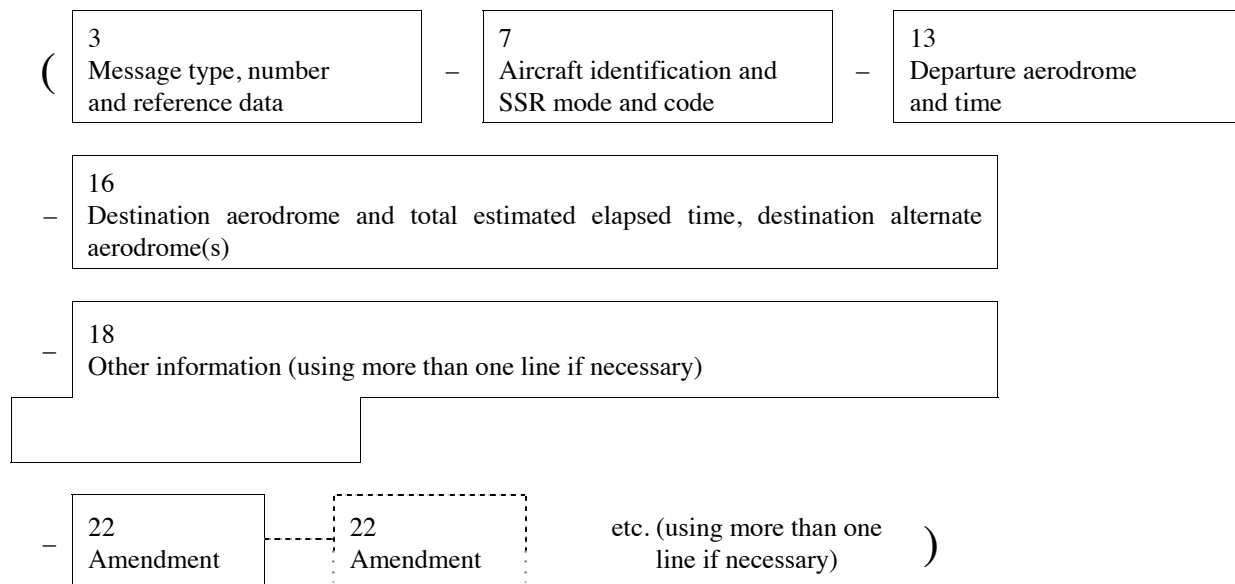
2.3.2 *Modification (CHG) message*2.3.2.1 *Composition*2.3.2.2 *Example*

The following is an example of a modification message sent by Amsterdam Centre to Frankfurt Centre correcting information previously sent to Frankfurt in a filed flight plan message. It is assumed that both centres are computer-equipped.

(CHGA/F016A/F014-GABWE/A2173-EHAM0850-EDDF-DOF/080122-8/I-16/EDDN)

2.3.2.2.1 *Meaning*

Modification message – Amsterdam and Frankfurt computer unit identifiers A and F, followed by serial number (016) of this message sent by Amsterdam, repeat of computer unit identifiers followed by serial number (014) of the related filed flight plan message – aircraft identification GABWE, SSR Code 2173 operating in Mode A, en route from Amsterdam EOBT0850 to Frankfurt date of flight 22 Jan 2008 – Field Type 8 of the related filed flight plan message is corrected to IFR – Field Type 16 of the related filed flight plan is corrected, the new destination is Nürnberg.

2.3.3 Flight plan cancellation (CNL) message

2.3.3.1 Composition

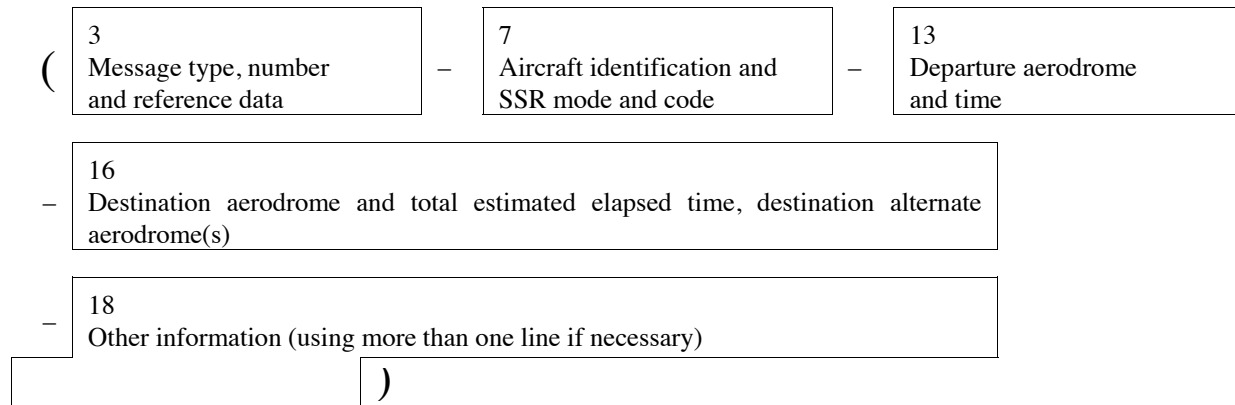

2.3.3.2 Example 1

The following is an example of a flight plan cancellation message sent by an ATS unit to all addressees of a filed flight plan message previously sent by that unit.

(CNL-DLH522-EDBB0900-LFPO-0)

2.3.3.2.1 Meaning

Flight plan cancellation message — cancel the flight plan of aircraft identification DLH522 — flight planned from Berlin EOBT0900 to Paris — no other information.

2.3.3.3 Example 2

The following is an example of a flight plan cancellation message sent by a centre to an adjacent centre. It is assumed that both centres are equipped with ATC computers.

(CNLF/B127F/B055-BAW580-EDDF1430-EDDW-0)

2.3.3.3.1 Meaning

Flight plan cancellation message — identifiers of sending and receiving ATC computer units F and B, followed by serial number (127) of this message, repeat of computer unit identifiers followed by serial number (055) of current flight plan message previously transmitted — cancel the flight plan of aircraft identification BAW580 — flight planned from Frankfurt EOBT1430 to Bremen — no other information.

2.3.4 Delay (DLA) message

2.3.4.1 Composition

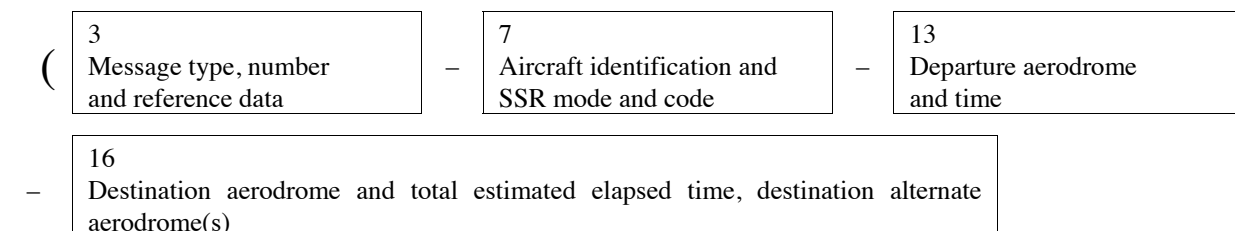

– 18
Other information (using more than one line if necessary)
)

2.3.4.2 Example

The following is an example of a delay message sent from a departure aerodrome, or from a parent unit handling communications for a departure aerodrome, to each addressee of a filed flight plan message.

(DLA-KLM671-LIRF0900-LYDU-0)

2.3.4.2.1 Meaning

Delay message — aircraft identification KLM671 — revised estimated off-block time Fiumicino 0900 UTC destination Dubrovnik — no other information.

2.3.5 Departure (DEP) message

2.3.5.1 Composition

(3 Message type, number and reference data – 7 Aircraft identification and SSR mode and code – 13 Departure aerodrome and time
– 16 Destination aerodrome and total estimated elapsed time, destination alternate aerodrome(s)
– 18 Other information (using more than one line if necessary)
)

2.3.5.2 Example

The following is an example of a departure message sent from a departure aerodrome, or from a parent unit handling communications for a departure aerodrome, to each addressee of a filed flight plan message.

(DEP-CSA4311-EGPD1923-ENZV-0)

2.3.5.2.1 Meaning

Departure message — aircraft identification CSA4311 — departed from Aberdeen at 1923 UTC — destination Stavanger — no other information.

2.3.6 Arrival (ARR) message

2.3.6.1 Composition

(3 Message type, number and reference data – 7 Aircraft identification and SSR mode and code – 13 Departure aerodrome and time

- | |
|----------------------------------|
| 17
Arrival aerodrome and time |
|----------------------------------|

)

2.3.6.2 Example 1

The following is an example of an arrival message sent from the arrival aerodrome (= destination) to the departure aerodrome.

(ARR-CSA406-LHBP0800-LKPR0913)

2.3.6.2.1 Meaning

Arrival message — aircraft identification CSA406 — departed from Budapest/Ferihegy at 0800 — landed at Prague/Ruzyne Airport at 0913 UTC.

2.3.6.3 Example 2

The following is an example of an arrival message sent for an aircraft which has landed at an aerodrome for which no ICAO location indicator has been allocated. The SSR code would not be meaningful.

(ARR-HHE13-EHAM0900 – EDDD – ZZZZ1030 DEN HELDER)

2.3.6.3.1 Meaning

Arrival message aircraft identification HHE13 — departed from Amsterdam at 0900 — destination Frankfurt – landed at Den Helder heliport at 1030 UTC.

2.4 Coordination messages

2.4.1 Current flight plan (CPL) message

2.4.1.1 Composition

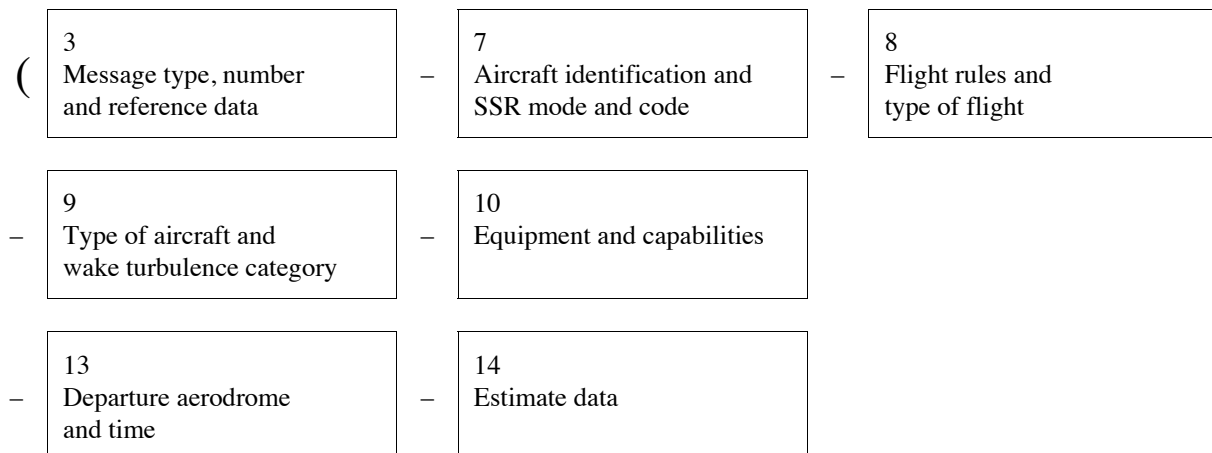

-	15 Route (using more than one line if necessary)
-	16 Destination aerodrome and total estimated elapsed time, destination alternate aerodrome(s)
-	18 Other information (using more than one line if necessary)

2.4.1.2 Example 1

The following is an example of a current flight plan message sent from Boston Centre to New York Centre on a flight which is en route from Boston to La Guardia Airport.

```
(CPL-UAL621/A5120-IS
-A320/M-S/C
-KBOS-HFD/1341A220A200A
-N0420A220 V3 AGL V445
-KLGA
-0)
```

2.4.1.3 Example 2

The following is an example of the same current flight plan message, but in this case the message is exchanged between ATC computers.

```
(CPLBOS/LGA052-UAL621/A5120-IS
-A320/M-S/C
-KBOS-HFD/1341A220A200A
-N0420A220 V3 AGL V445
-KLGA
-0)
```

Note.— The messages in Examples 1 and 2 are identical except that the Message Number of Example 2 does not appear in Example 1.

2.4.1.4 Meaning

Current flight plan message [with sending unit identity (BOS) and receiving unit identity (LGA), followed by the serial number of this message (052)] — aircraft identification UAL621, last assigned SSR Code 5120 in Mode A — IFR, scheduled flight — one A320, medium wake turbulence category, equipped with standard communications, navigation and approach aid equipment for the route and SSR transponder with Modes A (4 096 code capability) and C —

departed Boston — the flight is estimated to cross the Boston/New York “boundary” at point HFD at 1341 UTC, cleared by the Boston Centre at altitude 22 000 feet but to be at or above altitude 20 000 feet at HFD — TAS is 420 knots, requested cruising level is altitude 22 000 feet — the flight will proceed on airway V3 to reporting point AGL thence on airway V445 — destination is La Guardia Airport — no other information.

2.4.2 Estimate (EST) message

2.4.2.1 Composition

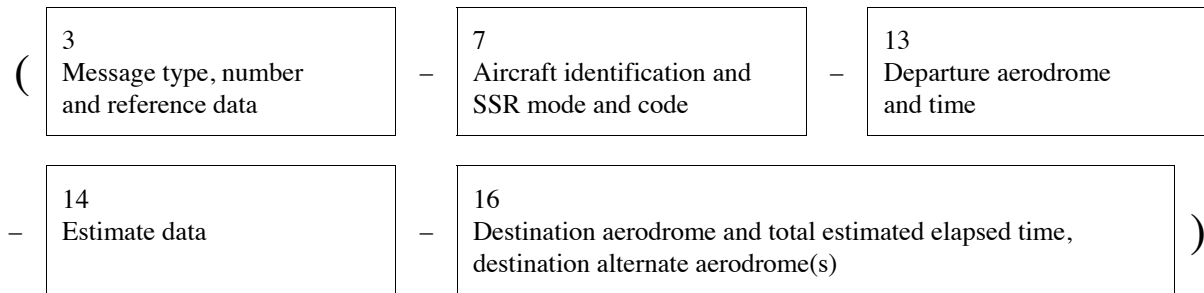

2.4.2.2 Example

The following is an example of an estimate message sent from Paris Centre to London Centre. It is assumed that London Centre has received a filed flight plan message relating to this flight. Both centres are equipped with computers.

(ESTP/L027-BAW671/A5631-LFPG-ABB/1548F140F110A-EGLL)

2.4.2.2.1 Meaning

Estimate message [with sending unit identity (P) and receiving unit identity (L), followed by the serial number of this message (027)] — aircraft identification BAW671, last assigned SSR Code 5631 operating in Mode A — departure aerodrome Paris de Gaulle — estimating Abbeville VOR 1548 UTC, cleared FL 140, flight will cross the Abbeville VOR at FL 110 or above, ascending — destination aerodrome London.

2.4.3 Coordination (CDN) message

2.4.3.1 Composition

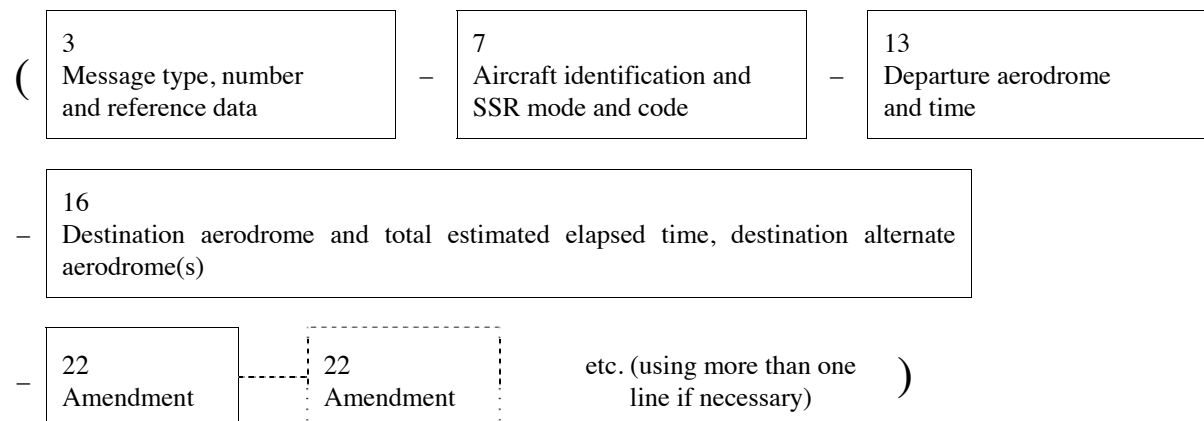

2.4.3.2 Example

The following is an example of a coordination message sent from Prestwick Centre to Dublin Centre proposing changes to the conditions under which an aircraft should cross the Dublin/Prestwick boundary. Prestwick has received a current flight plan message from Dublin and both centres are equipped with ATC computers.

(CDNP/D098D/P036-BAW617/A5136-EIDW-EGPK-14/GRN/1735F210F130A)

2.4.3.2.1 Meaning

Coordination message — Prestwick and Dublin ATC computer unit identifiers, P and D, followed by serial number (098) of this message sent by Prestwick, followed by analogous data identifying the current flight plan message sent from Dublin to which it is related (D/P036) — aircraft identification BAW617/SSR Code 5136 operating in Mode A — en route from Dublin to Prestwick — Field Type 14 is the subject of the proposal, i.e. Prestwick will accept the flight at the boundary point GRN at 1735 UTC and crossing the boundary point at or above FL 130 climbing to a cleared level of FL 210.

2.4.4 Acceptance (ACP) message

2.4.4.1 Composition

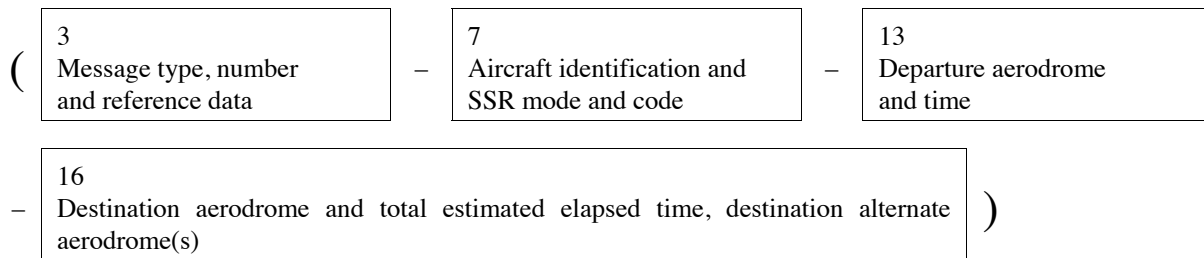

2.4.4.2 Example

The following is an example of an acceptance message sent from London Centre to Paris Centre relating to a current flight plan message which London has received from Paris. It is assumed that both centres are equipped with ATC computers.

(ACPL/P086P/L142-EIN065/A4570-LFPO-EGLL)

2.4.4.2.1 Meaning

Acceptance message — London and Paris computer unit identifiers, L and P, followed by serial number (086) of this message sent by London, followed by analogous data identifying the current flight plan message sent from Paris, to which it is related (PL142) — aircraft identification EIN065/SSR Code 4570 operating in Mode A — en route from Paris to London — is acceptable.

2.4.5 Logical acknowledgement (LAM) message

2.4.5.1 Composition

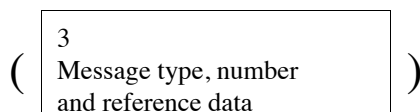

2.4.5.2 Example

The following is an example of a logical acknowledgement message sent by a centre to an adjacent centre reacting to a current flight plan message. It is assumed that both centres are equipped with ATC computers.

(LAMP/M178M/P100)

2.4.5.2.1 Meaning

Logical acknowledgement message — identifiers of sending and receiving ATC computer units Paris and Maastricht, followed by the sending unit serial number (178) of this message, followed by the computer unit identifiers and serial number (100) of the related estimate message.

2.5 Supplementary messages

2.5.1 Request flight plan (RQP) message

2.5.1.1 Composition

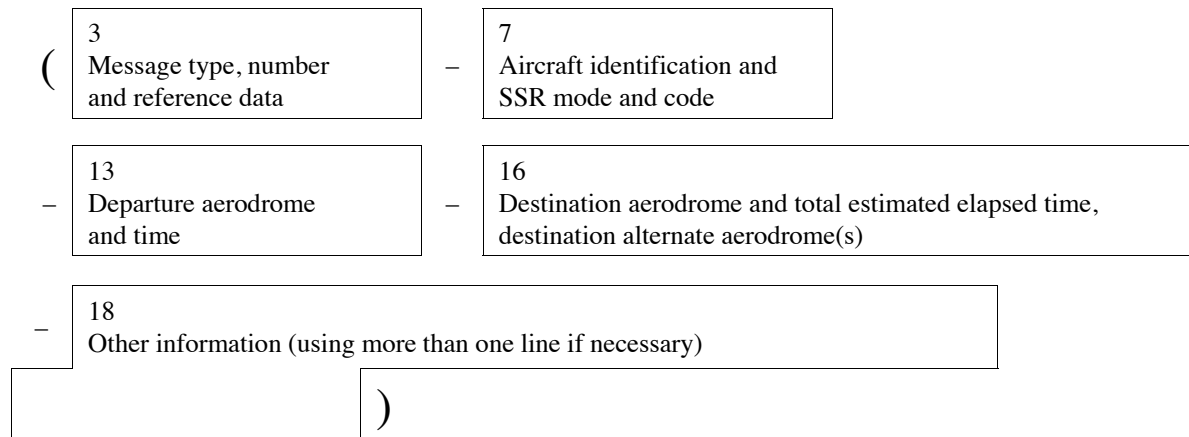

2.5.1.2 Example

The following is an example of a request flight plan message sent by a centre to an adjacent centre after receipt of an estimate message, for which no corresponding filed flight plan message had been received previously.

(RQP-PHOEN-EHRD-EDDL-0)

2.5.1.2.1 Meaning

Request flight plan message — aircraft identification PHOEN departed from Rotterdam — destination Düsseldorf — no other information.

2.5.2 Request supplementary flight plan (RQS) message

2.5.2.1 Composition

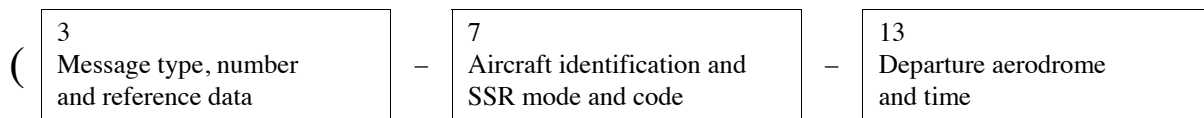

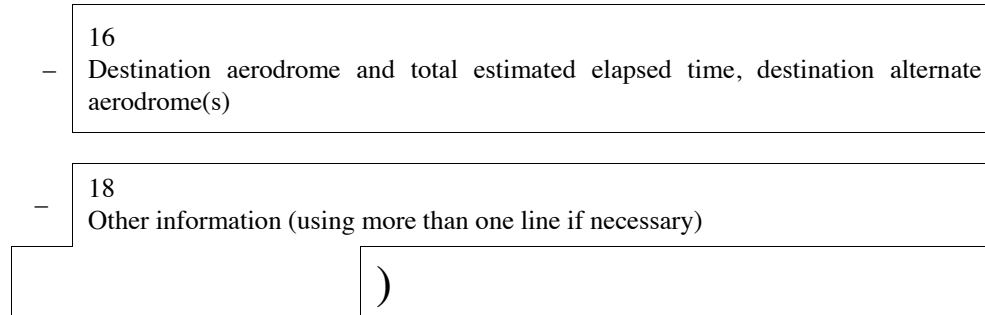

2.5.2.2 Example

The following is an example of a request supplementary flight plan message sent by an ATS unit to the ATS unit serving the departure aerodrome requesting information contained in the flight plan form, but not transmitted in the filed or current flight plan messages.

(RQS-KLM405/A4046-EHAM-CYMX-0)

2.5.2.2.1 Meaning

Request supplementary flight plan message — aircraft identification KLM405/SSR Code 4046 operating in Mode A — departure aerodrome is Amsterdam — destination aerodrome is Mirabel — no other information.

2.5.3 Supplementary flight plan (SPL) message

2.5.3.1 Composition

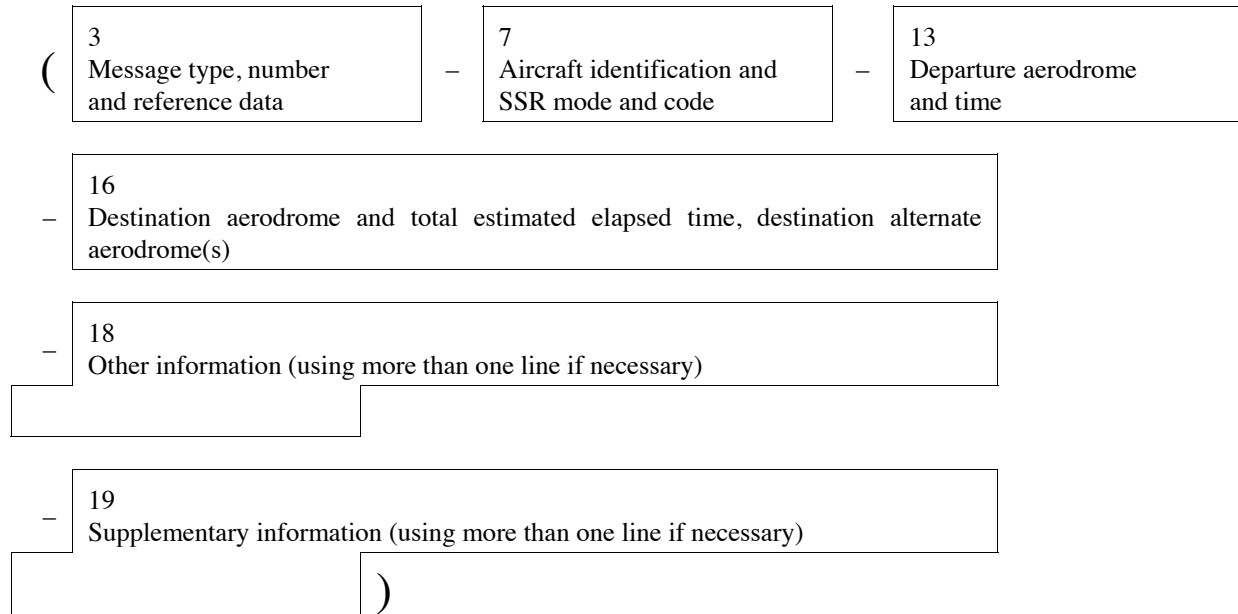

2.5.3.2 Example

The following is an example of a supplementary flight plan message sent by the departure aerodrome of a flight to an ATS unit which had requested supplementary information recorded on the flight plan form (but not transmitted in filed flight plan messages or current flight plan messages).

(SPL-SAW502A
-EDDW0920
-EKCH0400 EKVB
-REG/GBZTA RMK/CHARTER
-E/0640 P/9 R/V J/L A/BLUE C/DENKE)

2.5.3.2.1 Meaning

Supplementary flight plan message — aircraft identification SAW502A no SSR — departed Bremen 0920 UTC — destination Kastrup, total estimated elapsed time 4 hours — alternate Viborg — aircraft registration GBZTA — charter flight — endurance 6 hours and 40 minutes after departure — 9 persons on board — portable radio working on International Distress Frequency 121.5 MHz is carried — life jackets fitted with lights are carried — the aircraft colour is blue — the pilot's name is Denke.

Appendix 4

AIR TRAFFIC INCIDENT REPORT

1. ICAO model air traffic incident report form
2. Instructions for the completion of the air traffic incident report form

1. ICAO model air traffic incident report form

AIR TRAFFIC INCIDENT REPORT FORM		
<i>For use when submitting and receiving reports on air traffic incidents. In an initial report by radio, shaded items should be included.</i>		
A – AIRCRAFT IDENTIFICATION	B – TYPE OF INCIDENT	
	AIRPROX / PROCEDURE / FACILITY*	
C – THE INCIDENT		
1. General		
a)	Date / time of incident _____	UTC
b)	Position _____	
2. Own aircraft		
a)	Heading and route _____	
b)	True airspeed _____ measured in () kt _____ () km/h _____	
c)	Level and altimeter setting _____	
d)	Aircraft climbing or descending	
	() Level flight	() Climbing () Descending
e)	Aircraft bank angle	
	() Wings level	() Slight bank () Moderate bank
	() Steep bank	() Inverted () Unknown
f)	Aircraft direction of bank	
	() Left	() Right () Unknown
g)	Restrictions to visibility (select as many as required)	
	() Sun glare	() Windscreen pillar () Dirty windscreen
	() Other cockpit structure	() None
h)	Use of aircraft lighting (select as many as required)	
	() Navigation lights	() Strobe lights () Cabin lights
	() Red anti-collision lights	() Landing / taxi lights () Logo (tail fin) lights
	() Other	() None
i)	Traffic avoidance advice issued by ATS	
	() Yes, based on ATS surveillance system	() Yes, based on visual sighting () Yes, based on other information
	() No	
j)	Traffic information issued	
	() Yes, based on ATS surveillance system	() Yes, based on visual sighting () Yes, based on other information
	() No	

* Delete as appropriate.

k)	Airborne collision avoidance system — ACAS		
	<input type="checkbox"/> Not carried	<input type="checkbox"/> Type	<input type="checkbox"/> Traffic advisory issued
	<input type="checkbox"/> Resolution advisory issued	<input type="checkbox"/> Traffic advisory or resolution advisory not issued	
l)	Identification		
	<input type="checkbox"/> No ATS surveillance system available	<input type="checkbox"/> Identification	<input type="checkbox"/> No identification
m)	Other aircraft sighted		
	<input type="checkbox"/> Yes	<input type="checkbox"/> No	<input type="checkbox"/> Wrong aircraft sighted
n)	Avoiding action taken		
	<input type="checkbox"/> Yes	<input type="checkbox"/> No	
o)	Type of flight plan	IFR / VFR / none*	
3. Other aircraft			
a)	Type and call sign / registration (if known) _____		
b)	If a) above not known, describe below		
	<input type="checkbox"/> High wing	<input type="checkbox"/> Mid wing	<input type="checkbox"/> Low wing
	<input type="checkbox"/> Rotorcraft		
	<input type="checkbox"/> 1 engine	<input type="checkbox"/> 2 engines	<input type="checkbox"/> 3 engines
	<input type="checkbox"/> 4 engines	<input type="checkbox"/> More than 4 engines	
	Marking, colour or other available details		

c)	Aircraft climbing or descending		
	<input type="checkbox"/> Level flight	<input type="checkbox"/> Climbing	<input type="checkbox"/> Descending
	<input type="checkbox"/> Unknown		
d)	Aircraft bank angle		
	<input type="checkbox"/> Wings level	<input type="checkbox"/> Slight bank	<input type="checkbox"/> Moderate bank
	<input type="checkbox"/> Steep bank	<input type="checkbox"/> Inverted	<input type="checkbox"/> Unknown
e)	Aircraft direction of bank		
	<input type="checkbox"/> Left	<input type="checkbox"/> Right	<input type="checkbox"/> Unknown
f)	Lights displayed		
	<input type="checkbox"/> Navigation lights	<input type="checkbox"/> Strobe lights	<input type="checkbox"/> Cabin lights
	<input type="checkbox"/> Red anti-collision lights	<input type="checkbox"/> Landing / taxi lights	<input type="checkbox"/> Logo (tail fin) lights
	<input type="checkbox"/> Other	<input type="checkbox"/> None	<input type="checkbox"/> Unknown

* Delete as appropriate.

g)	Traffic avoidance advice issued by ATS	<input type="checkbox"/> Yes, based on ATS surveillance system <input type="checkbox"/> No	<input type="checkbox"/> Yes, based on visual sighting <input type="checkbox"/> Unknown	<input type="checkbox"/> Yes, based on other information <input type="checkbox"/> Unknown
h)	Traffic information issued	<input type="checkbox"/> Yes, based on ATS surveillance system <input type="checkbox"/> No	<input type="checkbox"/> Yes, based on visual sighting <input type="checkbox"/> Unknown	<input type="checkbox"/> Yes, based on other information <input type="checkbox"/> Unknown
i)	Avoiding action taken	<input type="checkbox"/> Yes	<input type="checkbox"/> No	<input type="checkbox"/> Unknown
4. Distance				
a)	Closest horizontal distance _____			
b)	Closest vertical distance _____			
5. Flight meteorological conditions				
a)	IMC / VMC*			
b)	Above / below* clouds / fog / haze or between layers*			
c)	Distance vertically from cloud _____ m / ft* below _____ m / ft* above			
d)	In cloud / rain / snow / sleet / fog / haze*			
e)	Flying into / out of* sun			
f)	Flight visibility _____ m / km*			
6. Any other information considered important by the pilot-in-command				

D – MISCELLANEOUS				
1. Information regarding reporting aircraft				
a)	Aircraft registration _____			
b)	Aircraft type _____			
c)	Operator _____			
d)	Aerodrome of departure _____			
e)	Aerodrome of first landing _____		Destination _____	
f)	Reported by radio or other means to _____ (name of ATS unit) at date/time _____ UTC			
g)	Date / time / place of completion of form _____			

* Delete as appropriate.

2. Function, address and signature of person submitting report

- a) Function _____
- b) Address _____
- c) Signature _____
- d) Telephone number _____

3. Function and signature of person receiving report

- a) Function _____ b) Signature _____

E – SUPPLEMENTARY INFORMATION BY ATS UNIT CONCERNED

1. Receipt of report

- a) Report received via AFTN / radio / telephone / other (specify)* _____
- b) Report received by _____ (name of ATS unit)

2. Details of ATS action

Clearance, incident seen (ATS surveillance system/visually, warning given, result of local enquiry, etc.)

DIAGRAMS OF AIRPROX

Mark passage of other aircraft relative to you, in plan on the left and in elevation on the right, assuming YOU are at the centre of each diagram. Include first sighting and passing distance.

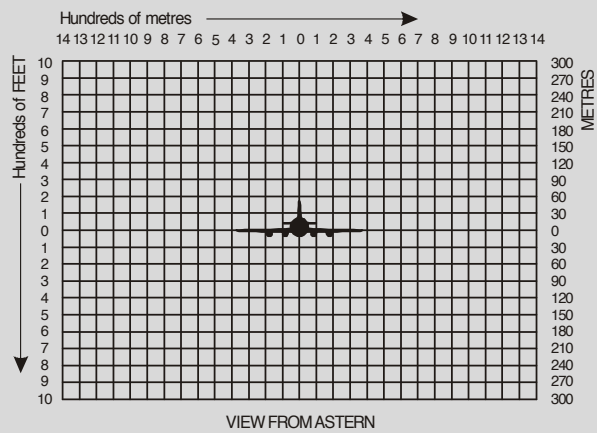
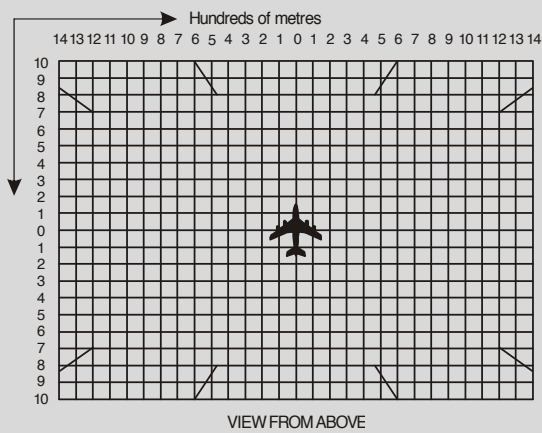

* Delete as appropriate.

2. Instructions for the completion of the air traffic incident report form*Item*

- A Aircraft identification of the aircraft filing the report.
 - B An AIRPROX report should be filed immediately by radio.
 - C1 Date/time UTC and position in bearing and distance from a navigation aid or in LAT/LONG.
 - C2 Information regarding aircraft filing the report, tick as necessary.
 - C2 c) E.g. FL 350/1 013 hPa or 2 500 ft/QNH 1 007 hPa or 1 200 ft/QFE 998 hPa.
 - C3 Information regarding the other aircraft involved.
 - C4 Passing distance — state units used.
 - C6 Attach additional papers as required. The diagrams may be used to show the aircraft's positions.
 - D1 f) State name of ATS unit and date/time in UTC.
 - D1 g) Date and time in UTC and place of completion of form.
 - E2 Include details of ATS unit such as service provided, radiotelephony frequency, SSR codes assigned and altimeter setting. Use diagram to show the aircraft's position and attach additional papers as required.
-

Appendix 5

CONTROLLER-PILOT DATA LINK COMMUNICATIONS (CPDLC) MESSAGE SET

Note 1.— The message identifier of the CPDLC message set in this appendix is derived from the operational category of the CPDLC message element. A message element identifier of specific technologies, correlated to those defined in this document can be found in the Global Operational Data Link (GOLD) Manual (Doc 10037).

Note 2.— Parameters contained in message elements are defined in Table A-5-14-1 of this appendix. When they are optional in a message element, parameters are denoted with an [O].

Table A5-1-1. Route uplinks (RTEU)	A5-2
Table A5-1-2. Route downlinks (RTED)	A5-4
Table A5-2-1. Lateral uplinks (LATU)	A5-5
Table A5-2-2. Lateral downlinks (LATD)	A5-6
Table A5-3-1. Level uplinks (LVLU)	A5-7
Table A5-3-2. Level downlinks (LVL D)	A5-10
Table A5-4-1. Crossing constraint uplinks (CSTU)	A5-12
Table A5-5-1. Speed uplinks (SPDU)	A5-13
Table A5-5-2. Speed downlinks (SPDD)	A5-15
Table A5-6-1. Air traffic advisory uplinks (ADVU)	A5-15
Table A5-6-2. Air traffic advisory downlinks (ADVD)	A5-17
Table A5-7-1. Voice communications uplinks (COMU)	A5-17
Table A5-7-2. Voice communications downlinks (COMD)	A5-18
Table A5-8-1. Spacing uplinks (SPCU)	A5-18
Table A5-8-2. Spacing downlinks (SPCD)	A5-19
Table A5-9-1. Emergency/urgency uplinks (EMGU)	A5-21
Table A5-9-2. Emergency/urgency downlinks (EMGD)	A5-21
Table A5-10-1. Standard response uplinks (RSPU)	A5-21
Table A5-10-2. Standard response downlinks (RSPD)	A5-22
Table A5-11-1. Supplemental uplinks (SUPU)	A5-23
Table A5-11-2. Supplemental downlinks (SUPD)	A5-23
Table A5-12-1. Free text uplinks (TXTU)	A5-24
Table A5-12-2. Free text downlinks (TXTD)	A5-24
Table A5-13-1. System management uplinks (SYSU)	A5-24
Table A5-13-2. System management downlinks (SYSD)	A5-25
Table A5-14-1. Parameters	A5-26

1. Route message elements

Table A5-1-1. Route uplinks (RTEU)

Instructions to proceed via the specified route or named procedure, or change the route, and notifications to expect route changes.

<i>Message element identifier</i>	<i>Message element intended use</i>	<i>Format for message element display</i>	<i>ALRT</i>	<i>RESP</i>
RTEU-1	Instruction to proceed via the specified departure clearance.	<i>(departure clearance)</i>	M	W/U
RTEU-2	Instruction to proceed directly to the specified position.	PROCEED DIRECT TO <i>(position)</i>	M	W/U
RTEU-3	Instruction to proceed, at the specified time, directly to the specified position.	AT TIME <i>(time)</i> PROCEED DIRECT TO <i>(position)</i>	M	W/U
RTEU-4	Instruction to proceed, at the specified position, directly to the next specified position.	AT <i>(Position)</i> PROCEED DIRECT TO <i>(position)</i>	M	W/U
RTEU-5	Instruction to proceed upon reaching the specified level, directly to the specified position.	AT <i>(level single)</i> PROCEED DIRECT TO <i>(position)</i>	M	W/U
RTEU-6	Instruction to proceed to the specified position via the specified route.	CLEARED TO <i>(position)</i> VIA <i>(departure data[O]) (en-route data)</i>	M	W/U
RTEU-7	Instruction to proceed via the specified route.	CLEARED <i>(departure data[O]) (en-route data) (arrival approach data)</i>	M	W/U
RTEU-8	Instruction to proceed in accordance with the specified procedure.	CLEARED <i>(procedure name)</i>	M	W/U
RTEU-9	Instruction to proceed from the specified position via the specified route.	AT <i>(position)</i> CLEARED <i>(en-route data) (arrival approach data)</i>	M	W/U
RTEU-10	Instruction to proceed from the specified position via the specified procedure.	AT <i>(position)</i> CLEARED <i>(procedure name)</i>	M	W/U

<i>Message element identifier</i>	<i>Message element intended use</i>	<i>Format for message element display</i>	<i>ALRT</i>	<i>RESP</i>
RTEU-11	Instruction to enter a holding pattern at the specified position in accordance with the specified instructions. <i>Note.— RTEU-13 EXPECT FURTHER CLEARANCE AT [time] is appended to this message when an extended hold is anticipated (Chapter 6, 6.5.7 and 6.5.8 refer).</i>	AT (<i>position</i>) HOLD INBOUND TRACK (<i>degrees</i>) (<i>direction</i>) TURNS (<i>leg type</i>) LEGS	M	W/U
RTEU-12	Instruction to enter a holding pattern at the specified position in accordance with the published holding instructions. <i>Note.— RTEU-13 EXPECT FURTHER CLEARANCE AT [time] is appended to this message when an extended hold is anticipated (Chapter 6, 6.5.7 and 6.5.8 refer).</i>	AT (<i>position</i>) HOLD AS PUBLISHED	M	W/U
RTEU-13	Notification that an onwards clearance may be issued at the specified time.	EXPECT FURTHER CLEARANCE AT TIME (<i>time</i>)	M	R
RTEU-14	Notification that a clearance may be issued for the aircraft to fly the specified procedure or clearance name.	EXPECT (<i>named instruction</i>)	M	R
RTEU-15	Request to confirm the assigned route.	CONFIRM ASSIGNED ROUTE	M	Y
RTEU-16	Request to make a position report.	REQUEST POSITION REPORT	M	Y
RTEU-17	Request to provide the estimated time of arrival at the specified position.	ADVISE ETA (<i>position</i>)	M	Y

Table A5-1-2. Route downlinks (RTED)

Requests to modify the route of flight.

<i>Message element identifier</i>	<i>Message element intended use</i>	<i>Format for message element display</i>	<i>ALRT</i>	<i>RESP</i>
RTED-1	Request for a direct clearance to the specified position.	REQUEST DIRECT TO <i>(position)</i>	M	Y
RTED-2	Request for the specified procedure or clearance name.	REQUEST <i>(named instruction)</i>	M	Y
RTED-3	Request for the specified route.	REQUEST CLEARANCE <i>(departure data[O]) (en-route data) (arrival approach data[O])</i>	M	Y
RTED-4	Request for the specified clearance.	REQUEST <i>(clearance type)</i> CLEARANCE	M	Y
RTED-5	Position report.	POSITION REPORT <i>(position report)</i>	M	N
RTED-6	Request for the specified heading.	REQUEST HEADING <i>(degrees)</i>	M	Y
RTED-7	Request for the specified ground track.	REQUEST GROUND TRACK <i>(degrees)</i>	M	Y
RTED-8	Request for the time or position that can be expected to rejoin the cleared route.	WHEN CAN WE EXPECT BACK ON ROUTE	M	Y
RTED-9	Confirmation that the assigned route is the specified route.	ASSIGNED ROUTE <i>(departure data[O]) (en-route data) (arrival approach data[O])</i>	M	N
RTED-10	Notification of estimated time of arrival at the specified position.	ETA <i>(position)</i> TIME <i>(time)</i>	M	N

2. Lateral message elements

Table A5-2-1. Lateral uplinks (LATU)

Instructions to fly a parallel route or rejoin the originally cleared route, clearances to deviate from assigned route and notifications to expect an offset change.

<i>Message element identifier</i>	<i>Message element intended use</i>	<i>Format for message element display</i>	<i>ALRT</i>	<i>RESP</i>
LATU-1	Instruction to fly a parallel track to the cleared route at a displacement of the specified distance in the specified direction.	OFFSET (<i>specified distance</i>) (<i>direction</i>) OF ROUTE	M	W/U
LATU-2	Instruction to fly a parallel track to the cleared route at a displacement of the specified distance in the specified direction and commencing at the specified position.	AT (<i>position</i>) OFFSET (<i>specified distance</i>) (<i>direction</i>) OF ROUTE	M	W/U
LATU-3	Instruction to fly a parallel track to the cleared route at a displacement of the specified distance in the specified direction and commencing at the specified time.	AT TIME (<i>time</i>) OFFSET (<i>specified distance</i>) (<i>direction</i>) OF ROUTE	M	W/U
LATU-4	Instruction to rejoin the cleared route.	REJOIN ROUTE	M	W/U
LATU-5	Instruction to rejoin the cleared route before passing the specified position.	REJOIN ROUTE BEFORE PASSING (<i>position</i>)	M	W/U
LATU-6	Instruction to rejoin the cleared route before the specified time.	REJOIN ROUTE BEFORE TIME (<i>time</i>)	M	W/U
LATU-7	Notification that a clearance may be issued to enable the aircraft to rejoin the cleared route before passing the specified position.	EXPECT BACK ON ROUTE BEFORE PASSING (<i>position</i>)	M	R
LATU-8	Notification that a clearance may be issued to enable the aircraft to rejoin the cleared route before the specified time.	EXPECT BACK ON ROUTE BEFORE TIME (<i>time</i>)	M	R
LATU-9	Instruction to resume own navigation following a period of tracking or heading clearances. May be used in conjunction with an instruction on how or where to rejoin the cleared route.	RESUME OWN NAVIGATION	M	W/U

<i>Message element identifier</i>	<i>Message element intended use</i>	<i>Format for message element display</i>	<i>ALRT</i>	<i>RESP</i>
LATU-10	Instruction allowing deviation up to the specified distance(s) from the cleared route in the specified direction(s).	CLEARED TO DEVIATE UP TO (<i>lateral deviation</i>) OF ROUTE	M	W/U
LATU-11	Instruction to turn left or right as specified on to the specified heading.	TURN (<i>direction</i>) HEADING (<i>degrees</i>)	M	W/U
LATU-12	Instruction to turn left or right as specified on to the specified track.	TURN (<i>direction</i>) GROUND TRACK (<i>degrees</i>)	M	W/U
LATU-13	Instruction to turn the specified number of degrees left or right.	TURN (<i>direction</i>) (<i>number of degrees</i>) DEGREES	M	W/U
LATU-14	Instruction to continue to fly the present heading.	CONTINUE PRESENT HEADING	M	W/U
LATU-15	Instruction to fly the specified heading upon reaching the specified position.	AT (<i>position</i>) FLY HEADING (<i>degrees</i>)	M	W/U
LATU-16	Instruction to fly the specified heading.	FLY HEADING (<i>degrees</i>)	M	W/U
LATU-17	Instruction to report when clear of weather.	REPORT CLEAR OF WEATHER	M	W/U
LATU-18	Instruction to report when the aircraft is back on the cleared route.	REPORT BACK ON ROUTE	M	W/U
LATU-19	Instruction to report upon passing the specified position.	REPORT PASSING (<i>position</i>)	M	W/U

Table A5-2-2. Lateral downlinks (LATD)

Requests to offset or deviate from route.

<i>Message element identifier</i>	<i>Message element intended use</i>	<i>Format for message element display</i>	<i>ALR T</i>	<i>RES P</i>
LATD-1	Request for a parallel track from the cleared route at a displacement of the specified distance in the specified direction.	REQUEST OFFSET (<i>specified distance</i>) (<i>direction</i>) OF ROUTE	M	Y
LATD-2	Request for a weather deviation up to the specified distance(s) off track in the specified direction(s).	REQUEST WEATHER DEVIATION UP TO (<i>lateral deviation</i>) OF ROUTE	M	Y
LATD-3	Report indicating that the aircraft is clear of weather.	CLEAR OF WEATHER	M	N

<i>Message element identifier</i>	<i>Message element intended use</i>	<i>Format for message element display</i>	<i>ALRT</i>	<i>RESP</i>
LATD-4	Report indicating that the cleared route has been rejoined.	BACK ON ROUTE	M	N
LATD-5	Report indicating diverting to the specified position via the specified route, which may be sent without any previous coordination done with ATC.	DIVERTING TO (<i>position</i>) VIA (<i>en-route data</i>) (<i>arrival approach data[O]</i>)	M	Y
LATD-6	Report indicating that the aircraft is offsetting to a parallel track at the specified distance in the specified direction from the cleared route.	OFFSETTING (<i>specified distance</i>) (<i>direction</i>) OF ROUTE	M	Y
LATD-7	Report indicating deviating specified distance or degrees in the specified direction from the cleared route.	DEVIATING (<i>specified deviation</i>) (<i>direction</i>) OF ROUTE	M	Y
LATD-8	Report indicating passing the specified position.	PASSING (<i>position</i>)	M	N

3. Level message elements

Table A5-3-1. Level uplinks (LVLU)

Instructions to change the assigned level, responses to level request, modifications or restrictions to level clearances, and notifications to expect level clearance.

<i>Message element identifier</i>	<i>Message element intended use</i>	<i>Format for message element display</i>	<i>ALRT</i>	<i>RESP</i>
LVLU-1	Notification that an instruction may be expected for the aircraft to commence climb at the specified time.	EXPECT HIGHER AT TIME (<i>time</i>)	M	R
LVLU-2	Notification that an instruction may be expected for the aircraft to commence climb at the specified position.	EXPECT HIGHER AT (<i>position</i>)	M	R
LVLU-3	Notification that an instruction may be expected for the aircraft to commence descent at the specified time.	EXPECT LOWER AT TIME (<i>time</i>)	M	R

<i>Message element identifier</i>	<i>Message element intended use</i>	<i>Format for message element display</i>	<i>ALRT</i>	<i>RESP</i>
LVLU-4	Notification that an instruction may be expected for the aircraft to commence descent at the specified position.	EXPECT LOWER AT <i>(position)</i>	M	R
LVLU-5	Instruction to maintain the specified level or vertical range.	MAINTAIN <i>(level)</i>	M	W/U
LVLU-6	Instruction that a climb to the specified level or vertical range is to commence and once reached is to be maintained.	CLIMB TO <i>(level)</i>	M	W/U
LVLU-7	Instruction that at the specified time a climb to the specified level or vertical range is to commence and once reached is to be maintained.	AT TIME <i>(time)</i> CLIMB TO <i>(level)</i>	M	W/U
LVLU-8	Instruction that at the specified position a climb to the specified level or vertical range is to commence and once reached is to be maintained.	AT <i>(position)</i> CLIMB TO <i>(level)</i>	M	W/U
LVLU-9	Instruction that a descent to the specified level or vertical range is to commence and once reached is to be maintained.	DESCEND TO <i>(level)</i>	M	W/U
LVLU-10	Instruction that at the specified time a descent to the specified level or vertical range is to commence and once reached is to be maintained.	AT TIME <i>(time)</i> DESCEND TO <i>(level)</i>	M	W/U
LVLU-11	Instruction that at the specified position a descent to the specified level or vertical range is to commence and once reached is to be maintained.	AT <i>(position)</i> DESCEND TO <i>(level)</i>	M	W/U
LVLU-12	Instruction that a climb is to be completed such that the specified level is reached before the specified time.	CLIMB TO REACH <i>(level single)</i> BEFORE TIME <i>(time)</i>	M	W/U
LVLU-13	Instruction that a climb is to be completed such that the specified level is reached before passing the specified position.	CLIMB TO REACH <i>(level single)</i> BEFORE PASSING <i>(position)</i>	M	W/U
LVLU-14	Instruction that a descent is to be completed such that the specified level is reached before the specified time.	DESCEND TO REACH <i>(level single)</i> BEFORE TIME <i>(time)</i>	M	W/U

<i>Message element identifier</i>	<i>Message element intended use</i>	<i>Format for message element display</i>	<i>ALRT</i>	<i>RESP</i>
LVLU-15	Instruction that a descent is to be completed such that the specified level is reached before passing the specified position.	DESCEND TO REACH (<i>level single</i>) BEFORE PASSING (<i>position</i>)	M	W/U
LVLU-16	Instruction to stop the climb at the specified level and, once reached, this level is to be maintained. The specified level will be below the previously assigned level. This instruction should only be issued when the controller can confirm that the previously assigned level has not yet been reached.	STOP CLIMB AT (<i>level single</i>)	M	W/U
LVLU-17	Instruction to stop the descent at the specified level and, once reached, this level is to be maintained. The specified level will be above the previously assigned level. This instruction should only be issued when the controller can confirm that the previously assigned level has not yet been reached.	STOP DESCENT AT (<i>level single</i>)	M	W/U
LVLU-18	Instruction to climb at the specified rate or greater.	CLIMB AT (<i>vertical rate</i>) OR GREATER	M	W/U
LVLU-19	Instruction to climb at the specified rate or less.	CLIMB AT (<i>vertical rate</i>) OR LESS	M	W/U
LVLU-20	Instruction to descend at the specified rate or greater.	DESCEND AT (<i>vertical rate</i>) OR GREATER	M	W/U
LVLU-21	Instruction to descend at the specified rate or less.	DESCEND AT (<i>vertical rate</i>) OR LESS	M	W/U
LVLU-22	Notification that a clearance may be issued for the aircraft to commence a climb to the specified level at the specified number of minutes after departure.	EXPECT (<i>level single</i>) (<i>number of minutes</i>) AFTER DEPARTURE	M	R
LVLU-23	Instruction to report upon leaving the specified level.	REPORT LEAVING (<i>level single</i>)	M	W/U
LVLU-24	Instruction to report when the aircraft is maintaining the specified level.	REPORT MAINTAINING (<i>level single</i>)	M	W/U
LVLU-25	Instruction to report the present level.	REPORT PRESENT LEVEL	M	Y
LVLU-26	Instruction to report upon reaching the specified vertical range.	REPORT REACHING BLOCK (<i>level single</i>) TO (<i>level single</i>)	M	W/U

<i>Message element identifier</i>	<i>Message element intended use</i>	<i>Format for message element display</i>	<i>ALRT</i>	<i>RESP</i>
LVLU-27	Request to confirm the assigned level.	CONFIRM ASSIGNED LEVEL	M	Y
LVLU-28	Request to provide the preferred level.	ADVISE PREFERRED LEVEL	M	Y
LVLU-29	Request to provide the preferred time and/or position to commence descent to the aerodrome of intended arrival.	ADVISE TOP OF DESCENT	L	Y
LVLU-30	Request for the earliest time or position when the specified level can be accepted.	WHEN CAN YOU ACCEPT (<i>level single</i>)	M	Y
LVLU-31	Request to indicate whether or not the specified level can be accepted at the specified position.	CAN YOU ACCEPT (<i>level single</i>) AT (<i>position</i>)	M	A/N
LVLU-32	Request to indicate whether or not the specified level can be accepted at the specified time.	CAN YOU ACCEPT (<i>level single</i>) AT TIME (<i>time</i>)	M	A/N

Table A5-3-2. Level downlinks (LVLD)

Requests to change the assigned altitude and inquiries when level change can be expected.

<i>Message element identifier</i>	<i>Message element intended use</i>	<i>Format for message element display</i>	<i>ALRT</i>	<i>RESP</i>
LVLD-1	Request to fly at the specified level or vertical range.	REQUEST (<i>level</i>)	M	Y
LVLD-2	Request for a climb to the specified level or vertical range.	REQUEST CLIMB TO (<i>level</i>)	M	Y
LVLD-3	Request for a descent to the specified level or vertical range.	REQUEST DESCENT TO (<i>level</i>)	M	Y
LVLD-4	Request for a climb/descent to the specified level or vertical range to commence at the specified position.	AT (<i>position</i>) REQUEST (<i>level</i>)	M	Y
LVLD-5	Request for a climb/descent to the specified level or vertical range to commence at the specified time.	AT TIME (<i>time</i>) REQUEST (<i>level</i>)	M	Y
LVLD-6	Request for the earliest time or position that a descent can be expected.	WHEN CAN WE EXPECT LOWER LEVEL	M	Y

<i>Message element identifier</i>	<i>Message element intended use</i>	<i>Format for message element display</i>	<i>ALRT</i>	<i>RESP</i>
LVLD-7	Request for the earliest time or position that a climb can be expected.	WHEN CAN WE EXPECT HIGHER LEVEL	M	Y
LVLD-8	Report indicating leaving the specified level.	LEAVING (<i>level single</i>)	M	N
LVLD-9	Report indicating that the specified level is being maintained.	MAINTAINING (<i>level single</i>)	M	N
LVLD-10	Report indicating reaching the specified vertical range.	REACHING BLOCK (<i>level single</i>) TO (<i>level single</i>)	M	N
LVLD-11	Confirmation that the assigned level or vertical range is the specified level or vertical range.	ASSIGNED LEVEL (<i>level</i>)	M	N
LVLD-12	Report indicating that the aircraft's preferred level is the specified level.	PREFERRED LEVEL (<i>level single</i>)	M	N
LVLD-13	Report indicating climbing to the specified level.	CLIMBING TO (<i>level single</i>)	M	N
LVLD-14	Report indicating descending to the specified level.	DESCENDING TO (<i>level single</i>)	M	N
LVLD-15	Indication that the specified level can be accepted at the specified time.	WE CAN ACCEPT (<i>level single</i>) AT TIME (<i>time</i>)	M	N
LVLD-16	Indication that the specified level can be accepted at the specified position.	WE CAN ACCEPT (<i>level single</i>) AT (<i>position</i>)	M	N
LVLD-17	Indication that the specified level cannot be accepted.	WE CANNOT ACCEPT (<i>level single</i>)	M	N
LVLD-18	Notification of the preferred time and position to commence descent for approach.	TOP OF DESCENT (<i>position</i>) TIME (<i>time</i>)	M	N

4. Crossing constraint message elements

Table A5-4-1. Crossing constraint uplinks (CSTU)

Instructions to cross a specified position at a specified altitude, time, and/or speed, instruction to cancel a crossing constraint.

<i>Message element identifier</i>	<i>Message element intended use</i>	<i>Format for message element display</i>	<i>ALRT</i>	<i>RESP</i>
CSTU-1	Instruction that the specified position is to be crossed at the specified level or within the specified vertical range.	CROSS (<i>position</i>) AT (<i>level</i>)	M	W/U
CSTU-2	Instruction that the specified position is to be crossed at or above the specified level.	CROSS (<i>position</i>) AT OR ABOVE (<i>level single</i>)	M	W/U
CSTU-3	Instruction that the specified position is to be crossed at or below the specified level.	CROSS (<i>position</i>) AT OR BELOW (<i>level single</i>)	M	W/U
CSTU-4	Instruction that the specified position is to be crossed at the specified time.	CROSS (<i>position</i>) AT TIME (<i>time</i>)	M	W/U
CSTU-5	Instruction that the specified position is to be crossed before the specified time.	CROSS (<i>position</i>) BEFORE TIME (<i>time</i>)	M	W/U
CSTU-6	Instruction that the specified position is to be crossed after the specified time.	CROSS (<i>position</i>) AFTER TIME (<i>time</i>)	M	W/U
CSTU-7	Instruction that the specified position is to be crossed between the specified times.	CROSS (<i>position</i>) BETWEEN TIME (<i>time</i>) AND TIME (<i>time</i>)	M	W/U
CSTU-8	Instruction that the specified position is to be crossed at the specified speed.	CROSS (<i>position</i>) AT (<i>speed</i>)	M	W/U
CSTU-9	Instruction that the specified position is to be crossed at or less than the specified speed.	CROSS (<i>position</i>) AT (<i>speed</i>) OR LESS	M	W/U
CSTU-10	Instruction that the specified position is to be crossed at or greater than the specified speed.	CROSS (<i>position</i>) AT (<i>speed</i>) OR GREATER	M	W/U
CSTU-11	Instruction that the specified position is to be crossed at the specified time and at the level or within the vertical range as specified.	CROSS (<i>position</i>) AT TIME (<i>time</i>) AT (<i>level</i>)	M	W/U

<i>Message element identifier</i>	<i>Message element intended use</i>	<i>Format for message element display</i>	<i>ALRT</i>	<i>RESP</i>
CSTU-12	Instruction that the specified position is to be crossed before the specified time and at the level or within the vertical range as specified.	CROSS (<i>position</i>) BEFORE TIME(<i>time</i>) AT (<i>level</i>)	M	W/U
CSTU-13	Instruction that the specified position is to be crossed after the specified time and at the level or within the vertical range as specified.	CROSS (<i>position</i>) AFTER TIME(<i>time</i>) AT (<i>level</i>)	M	W/U
CSTU-14	Instruction that the specified position is to be crossed at the level or within the vertical range, as specified, and at the specified speed.	CROSS (<i>position</i>) AT (<i>level</i>) AT (<i>speed</i>)	M	W/U
CSTU-15	Instruction that the specified position is to be crossed at the specified time at the level or within the vertical range, as specified, and at the specified speed.	CROSS (<i>position</i>) AT TIME (<i>time</i>) AT (<i>level</i>) AT (<i>speed</i>)	M	W/U

5. Speed message elements

Table A5-5-1. Speed uplinks (SPDU)

Instructions to change or maintain speed, notifications to expect speed change.

<i>Message element identifier</i>	<i>Message element intended use</i>	<i>Format for message element display</i>	<i>ALRT</i>	<i>RESP</i>
SPDU-1	Notification that a speed instruction may be issued to take effect at the specified time.	EXPECT SPEED CHANGE AT TIME (<i>time</i>)	M	R
SPDU-2	Notification that a speed instruction may be issued to take effect at the specified position.	EXPECT SPEED CHANGE AT (<i>position</i>)	M	R
SPDU-3	Notification that a speed instruction may be issued to take effect at the specified level.	EXPECT SPEED CHANGE AT (<i>level single</i>)	M	R
SPDU-4	Instruction to maintain the specified speed.	MAINTAIN (<i>speed</i>)	M	W/U
SPDU-5	Instruction to maintain the present speed.	MAINTAIN PRESENT SPEED	M	W/U

<i>Message element identifier</i>	<i>Message element intended use</i>	<i>Format for message element display</i>	<i>ALRT</i>	<i>RESP</i>
SPDU-6	Instruction to maintain the specified speed or greater.	MAINTAIN (<i>speed</i>) OR GREATER	M	W/U
SPDU-7	Instruction to maintain the specified speed or less.	MAINTAIN (<i>speed</i>) OR LESS	M	W/U
SPDU-8	Instruction to maintain the specified speed range.	MAINTAIN (<i>speed</i>) TO (<i>speed</i>)	M	W/U
SPDU-9	Instruction that the present speed is to be increased to the specified speed and maintained until further advised.	INCREASE SPEED TO (<i>speed</i>)	M	W/U
SPDU-10	Instruction that the present speed is to be increased to the specified speed or greater, and maintained at or above the specified speed until further advised.	INCREASE SPEED TO (<i>speed</i>) OR GREATER	M	W/U
SPDU-11	Instruction that the present speed is to be reduced to the specified speed and maintained until further advised.	REDUCE SPEED TO (<i>speed</i>)	M	W/U
SPDU-12	Instruction that the present speed is to be reduced to the specified speed, or less, and maintained at or below the specified speed until further advised.	REDUCE SPEED TO (<i>speed</i>) OR LESS	M	W/U
SPDU-13	Instruction to resume a normal speed. The aircraft no longer needs to comply with a previously issued speed restriction.	RESUME NORMAL SPEED	M	W/U
SPDU-14	Indication that the preferred speed may be flown without restriction.	NO SPEED RESTRICTION	M	R
SPDU-15	Request to report the speed defined by the specified speed type(s).	REPORT (<i>speed types</i>) SPEED	M	Y
SPDU-16	Request to confirm the assigned speed.	CONFIRM ASSIGNED SPEED	M	Y
SPDU-17	Request for the earliest time or position when the specified speed can be accepted.	WHEN CAN YOU ACCEPT (<i>speed</i>)	M	Y

Table A5-5-2. Speed downlinks (SPDD)

Requests related to speed and inquiries when speed change can be expected.

<i>Message element identifier</i>	<i>Message element intended use</i>	<i>Format for message element display</i>	<i>ALRT</i>	<i>RESP</i>
SPDD-1	Request for the specified speed.	REQUEST (<i>speed</i>)	M	Y
SPDD-2	Request for the earliest time or position that the specified speed can be expected.	WHEN CAN WE EXPECT (<i>speed</i>)	M	Y
SPDD-3	Report indicating the speed defined by the specified speed types is the specified speed.	(<i>speed types</i>) SPEED (<i>speed</i>)	M	N
SPDD-4	Confirmation that the assigned speed is the specified speed.	ASSIGNED SPEED (<i>speed</i>)	M	N
SPDD-5	Indication that the specified speed can be accepted at the specified time.	WE CAN ACCEPT (<i>speed</i>) AT TIME (<i>time</i>)	M	N
SPDD-6	Indication that the specified speed cannot be accepted.	WE CANNOT ACCEPT (<i>speed</i>)	M	N

6. Air traffic advisory message elements**Table A5-6-1. Air traffic advisory uplinks (ADVU)**

Advisories related to the use of CPDLC, ADS-C and surveillance services.

<i>Message element identifier</i>	<i>Message element intended use</i>	<i>Format for message element display</i>	<i>ALRT</i>	<i>RESP</i>
ADVU-1	Advisory providing the altimeter setting for the specified facility.	(<i>facility Designation</i>) ALTIMETER (<i>altimeter setting</i>)	M	R
ADVU-2	Advisory that ATS surveillance service is terminated.	SURVEILLANCE SERVICE TERMINATED	M	R
ADVU-3	Advisory that ATS surveillance service has been established. A position may be specified.	IDENTIFIED (<i>position[O]</i>)	M	R
ADVU-4	Advisory that ATS surveillance contact has been lost.	IDENTIFICATION LOST	M	R
ADVU-5	Advisory that the current ATIS code is as specified.	ATIS (<i>ATIS code</i>)	M	R
ADVU-6	Advisory to request again with the next ATC unit.	REQUEST AGAIN WITH NEXT ATC UNIT	M	N

<i>Message element identifier</i>	<i>Message element intended use</i>	<i>Format for message element display</i>	<i>ALRT</i>	<i>RESP</i>
ADVU-7	Advisory of traffic significant to the flight.	TRAFFIC IS (<i>traffic description</i>)	M	R
ADVU-8	Instruction to report that the specified traffic has been visually sighted and passed. The instruction may indicate the estimated time of passing.	REPORT SIGHTING AND PASSING OPPOSITE DIRECTION (<i>aircraft type[O]</i>) (<i>traffic location</i>) (<i>ETP time[O]</i>)	M	W/U
ADVU-9	Instruction to select the specified SSR code.	SQUAWK (<i>SSR code</i>)	M	W/U
ADVU-10	Instruction to disable SSR transponder responses.	STOP SQUAWK	M	W/U
ADVU-11	Instruction to stop ADS-B transmissions.	STOP ADS-B TRANSMISSION	M	W/U
ADVU-12	Instruction to include level information in SSR transponder responses.	SQUAWK MODE C	M	W/U
ADVU-13	Instruction to stop including level information in SSR transponder responses.	STOP SQUAWK MODE C	M	W/U
ADVU-14	Request to confirm the selected SSR code.	CONFIRM SQUAWK CODE	M	Y
ADVU-15	Instruction that the “ident” function on the SSR transponder is to be actuated.	SQUAWK IDENT	M	W/U
ADVU-16	Instruction to activate the ADS-C capability.	ACTIVATE ADS-C	M	W/U
ADVU-17	Instruction to transmit voice position reports, as specified, due to ADS-C being out of service.	ADS-C OUT OF SERVICE REVERT TO VOICE POSITION REPORTS	M	W/U
ADVU-18	Instruction to intermediary aircraft to relay the specified message to the specified aircraft on the specified frequency, when provided.	RELAY TO (<i>aircraft identification</i>) (<i>unit name</i>) (<i>relay text</i>) (<i>frequency[O]</i>)	M	W/U
ADVU-19	Request to check the aircraft lateral position, level or speed due to the ATC unit detecting a deviation from the clearance.	(<i>deviation type</i>) DEVIATION DETECTED. VERIFY AND ADVISE	M	W/U

Table A5-6-2. Air traffic advisory downlinks (ADVD)

Reports related to the application of relay procedure.

<i>Message element identifier</i>	<i>Message element intended use</i>	<i>Format for message element display</i>	<i>ALRT</i>	<i>RESP</i>
ADVD-1	Report indicating that the aircraft is squawking the specified SSR code.	SQUAWKING (<i>SSR code</i>)	M	N
ADVD-2	Report indicating that whether or not traffic has been visually sighted and if so, if it has been passed. May provide a description of the aircraft.	TRAFFIC (<i>aircraft type[O]</i>) (<i>traffic location</i>) (<i>traffic visibility</i>)	M	N

7. Voice communications message elements**Table A5-7-1. Voice communications uplinks (COMU)**

Instructions to monitor or contact air traffic control on voice frequencies and instructions to check stuck microphone.

<i>Message element identifier</i>	<i>Message element intended use</i>	<i>Format for message element display</i>	<i>ALRT</i>	<i>RESP</i>
COMU-1	Instruction to establish voice contact with the specified ATS unit on the specified frequency.	CONTACT (<i>unit name</i>) (<i>frequency</i>)	M	W/U
COMU-2	Instruction at the specified position, to establish voice contact with the specified ATS unit on the specified frequency.	AT (<i>position</i>) CONTACT (<i>unit name</i>) (<i>frequency</i>)	M	W/U
COMU-3	Instruction at the specified time to establish voice contact with the specified ATS unit on the specified frequency.	AT TIME (<i>time</i>) CONTACT (<i>unit name</i>) (<i>frequency</i>)	M	W/U
COMU-4	Advisory of the secondary frequency.	SECONDARY FREQUENCY (<i>frequency</i>)	M	R
COMU-5	Instruction to monitor the specified ATS unit on the specified frequency. The flight crew is not required to establish voice contact on the frequency.	MONITOR (<i>unit name</i>) (<i>frequency</i>)	M	W/U
COMU-6	Instruction at the specified position to monitor the specified ATS on the specified frequency. The flight crew is not required to establish voice contact on the frequency.	AT (<i>position</i>) MONITOR (<i>unit name</i>) (<i>frequency</i>)	M	W/U

<i>Message element identifier</i>	<i>Message element intended use</i>	<i>Format for message element display</i>	<i>ALRT</i>	<i>RESP</i>
COMU-7	Instruction that at the specified time to monitor the specified ATS unit on the specified frequency. The flight crew is not required to establish voice contact on the frequency.	AT TIME (<i>time</i>) MONITOR (<i>unit name</i>) (<i>frequency</i>)	M	W/U
COMU-8	Instruction to check the microphone due to detection of a continuous transmission on the specified frequency.	CHECK STUCK MICROPHONE (<i>frequency</i>)	H	N
COMU-9	Advisory of the name of the current ATC unit.	CURRENT ATC UNIT (<i>unit name</i>)	M	N

Table A5-7-2. Voice communications downlinks (COMD)

Requests regarding voice contact or frequency change.

<i>Message element identifier</i>	<i>Message element intended use</i>	<i>Format for message element display</i>	<i>ALRT</i>	<i>RESP</i>
COMD-1	Request for voice contact on the specified-frequency.	REQUEST VOICE CONTACT (<i>frequency</i>)	M	Y
COMD-2	Notification from the intermediary aircraft of the specified response from the specified aircraft.	RELAY FROM (<i>aircraft identification</i>) (<i>relayed text response</i>)	M	N

8. Spacing message elements**Table A5-8-1. Spacing uplinks (SPCU)**

Clearances to conduct spacing manoeuvre during en-route or arrival operations and notifications to expect spacing clearance.

<i>Message element identifier</i>	<i>Message element intended use</i>	<i>Format for message element display</i>	<i>ALRT</i>	<i>RESP</i>
SPCU-1	ATS acknowledgement for the pilot use of the in-trail procedure when the ITP aircraft is behind the reference aircraft. This message element is always concatenated with a vertical clearance.	ITP BEHIND (<i>aircraft identification</i>)	M	N

<i>Message element identifier</i>	<i>Message element intended use</i>	<i>Format for message element display</i>	<i>ALRT</i>	<i>RESP</i>
SPCU-2	ATS acknowledgement for the pilot use of the in-trail procedure when the ITP aircraft is ahead of the reference aircraft. This message element is always concatenated with a vertical clearance.	ITP AHEAD OF (<i>aircraft identification</i>)	M	N
SPCU-3	ATS acknowledgement for the pilot use of the in-trail procedure when the ITP aircraft is behind both reference aircraft. This message element is always concatenated with a vertical clearance.	ITP BEHIND (<i>aircraft identification</i>) AND BEHIND (<i>aircraft identification</i>)	M	N
SPCU-4	ATS acknowledgement for the pilot use of the in-trail procedure when the ITP aircraft is ahead of both reference aircraft. This message element is always concatenated with a vertical clearance.	ITP AHEAD OF (<i>aircraft identification</i>) AND AHEAD OF (<i>aircraft identification</i>)	M	N
SPCU-5	ATS acknowledgement for the pilot use of the in-trail procedure when the ITP aircraft is behind one reference aircraft and ahead of one reference aircraft. This message element is always concatenated with a vertical clearance.	ITP BEHIND (<i>aircraft identification</i>) AND AHEAD OF (<i>aircraft identification</i>)	M	M

Table A5-8-2. Spacing downlinks (SPCD)

Responses and reports to conduct spacing manoeuvre during en-route or arrival operations.

<i>Message element identifier</i>	<i>Message element intended use</i>	<i>Format for message element display</i>	<i>ALRT</i>	<i>RESP</i>
SPCD-1	Advisory indicating that the pilot has the ITP equipment, and provides the specified distance to the reference aircraft, including aircraft identification. This message element is always concatenated with a vertical request.	ITP (<i>specified distance</i>) BEHIND (<i>aircraft identification</i>)	M	N

<i>Message element identifier</i>	<i>Message element intended use</i>	<i>Format for message element display</i>	<i>ALRT</i>	<i>RESP</i>
SPCD-2	Advisory indicating that the pilot has the ITP equipment, and provides the specified distance from the reference aircraft, including aircraft identification. This message element is always concatenated with a vertical request.	ITP (<i>specified distance</i>) AHEAD OF (<i>aircraft identification</i>)	M	N
SPCD-3	Advisory indicating that the pilot has the ITP equipment, and provides the specified distance to both reference aircraft, including aircraft identification. This message element is always concatenated with a vertical request.	ITP (<i>specified distance</i>) BEHIND (<i>aircraft identification</i>) AND (<i>specified distance</i>) BEHIND (<i>aircraft identification</i>)	M	N
SPCD-4	Advisory indicating that the pilot has the ITP equipment, and provides the specified distance from both reference aircraft, including aircraft identification. This message element is always concatenated with a vertical request.	ITP (<i>specified distance</i>) AHEAD OF (<i>aircraft identification</i>) AND (<i>specified distance</i>) AHEAD OF (<i>aircraft identification</i>)	M	N
SPCD-5	Advisory indicating that the pilot has the ITP equipment, and provides the specified distance to one reference aircraft and the specified distance from another reference aircraft, including aircraft identification. This message element is always concatenated with a vertical request.	ITP (<i>specified distance</i>) BEHIND (<i>aircraft identification</i>) AND (<i>specified distance</i>) AHEAD OF (<i>aircraft identification</i>)	M	N

9. Emergency/urgency message elements

Table A5-9-1. Emergency/urgency uplinks (EMGU)

Instructions or annotations associated to instructions providing a high level of alert in the cockpit.

<i>Message element identifier</i>	<i>Message element intended use</i>	<i>Format for message element display</i>	<i>ALRT</i>	<i>RESP</i>
EMGU-1	Request to provide the fuel remaining (time) and the number of persons on board.	REPORT ENDURANCE AND PERSONS ON BOARD	H	Y
EMGU-2	Instruction to immediately comply with the associated instruction to avoid an imminent situation.	IMMEDIATELY	H	N
EMGU-3	Request to confirm an ADS-C indicated emergency.	CONFIRM ADS-C EMERGENCY	H	A/N

Table A5-9-2. Emergency/urgency downlinks (EMGD)

Reports providing a high level of alert to the air traffic control.

<i>Message element identifier</i>	<i>Message element intended use</i>	<i>Format for message element display</i>	<i>ALRT</i>	<i>RESP</i>
EMGD-1	Indication of an urgent situation.	PAN PAN PAN	H	Y
EMGD-2	Indication of an emergency situation.	MAYDAY MAYDAY MAYDAY	H	Y
EMGD-3	Report indicating fuel remaining (time) and number of persons on board.	<i>(remaining fuel)</i> ENDURANCE AND <i>(persons on board)</i> PERSONS ON BOARD	H	Y
EMGD-4	Indication that the emergency situation is cancelled.	CANCEL EMERGENCY	H	Y

10. Standard response message elements

Table A5-10-1. Standard response uplinks (RSPU)

Standard air traffic control responses to pilot inquiries and requests.

<i>Message element identifier</i>	<i>Message element intended use</i>	<i>Format for message element display</i>	<i>ALRT</i>	<i>RESP</i>
RSPU-1	Indication that the message cannot be complied with.	UNABLE	M	N
RSPU-2	Indication that the message will be responded to shortly.	STANDBY	M	N

<i>Message element identifier</i>	<i>Message element intended use</i>	<i>Format for message element display</i>	<i>ALRT</i>	<i>RESP</i>
RSPU-3	Indication that a long-term delay in response can be expected.	REQUEST DEFERRED	M	N
RSPU-4	Indication that the message is received.	ROGER	M	N
RSPU-5	Indication that ATC is responding positively to the message.	AFFIRM	M	N
RSPU-6	Indication that ATC is responding negatively to the message.	NEGATIVE	M	N
RSPU-7	Indication that the request has been forwarded to the next control unit.	REQUEST FORWARDED	M	N
RSPU-8	Request to confirm the referenced request since the initial request was not understood. The request should be clarified and resubmitted.	CONFIRM REQUEST	M	N

Table A5-10-2. Standard response downlinks (RSPD)

Standard responses to air traffic control instructions and inquiries.

<i>Message element identifier</i>	<i>Message element intended use</i>	<i>Format for message element display</i>	<i>ALRT</i>	<i>RESP</i>
RSPD-1	Indication that the instruction is understood and will be complied with.	WILCO	M	N
RSPD-2	Indication that the instruction cannot be complied with.	UNABLE	M	N
RSPD-3	Indication that the message will be responded to shortly.	STANDBY	M	N
RSPD-4	Indication that the message is received.	ROGER	M	N
RSPD-5	Indication of a positive response to a message.	AFFIRM	M	N
RSPD-6	Indication of a negative response to a message.	NEGATIVE	M	N

11. Supplemental message elements

Table A5-11-1. Supplemental uplinks (SUPU)

Annotations to air traffic control instructions and standard responses.

<i>Message element identifier</i>	<i>Message element intended use</i>	<i>Format for message element display</i>	<i>ALRT</i>	<i>RESP</i>
SUPU-1	Indication that the associated instruction is to be executed when the flight crew is ready.	WHEN READY	M	N
SUPU-2	Indication that the associated message is issued due to the specified reason.	DUE TO (<i>specified reason uplink</i>)	M	N
SUPU-3	Instruction to execute the associated instruction at the aircraft's best performance rate.	EXPEDITE	M	N
SUPU-4	Indication that the associated instruction is either a revision to a previously issued instruction or is different from the requested clearance.	REVISED (<i>revision reason[O]</i>)	H	N

Table A5-11-2. Supplemental downlinks (SUPD)

Annotations to requests and standard responses.

<i>Message element identifier</i>	<i>Message element intended use</i>	<i>Format for message element display</i>	<i>ALRT</i>	<i>RESP</i>
SUPD-1	Indication that the associated message is issued due to specified reason.	DUE TO (<i>specified reason downlink</i>)	N	N

12. Free text message elements

Used when none of the standard message elements in the CPDLC message set in this appendix are appropriate for a specific intended use.

Table A5-12-1. Free text uplinks (TXTU)

<i>Message element identifier</i>	<i>Message element intended use</i>	<i>Format for message element display</i>	<i>ALRT</i>	<i>RESP</i>
TXTU-1		<i>(free text)</i>	M	R
TXTU-2		<i>(free text)</i>	M	N
TXTU-3		<i>(free text)</i>	N	N
TXTU-4		<i>(free text)</i>	M	W/U
TXTU-5		<i>(free text)</i>	M	A/N

Table A5-12-2. Free text downlinks (TXTD)

<i>Message element identifier</i>	<i>Message element intended use</i>	<i>Format for message element display</i>	<i>ALRT</i>	<i>RESP</i>
TXTD-1		<i>(free text)</i>	M	Y
TXTD-2		<i>(free text)</i>	M	N

13. System management message elements

Table A5-13-1. System management uplinks (SYSU)

Messages dedicated to the management of the CPDLC communications (usually sent by the ground system).

<i>Message element identifier</i>	<i>Message element intended use</i>	<i>Format for message element display</i>	<i>ALRT</i>	<i>RESP</i>
SYSU-1	System-generated notification of an error.	ERROR (<i>error information</i>)	N	N
SYSU-2	System-generated notification of the next data authority or the cancellation thereof.	NEXT DATA AUTHORITY (<i>facility designation[O]</i>)	M	N
SYSU-3	System-generated notification that the received message is not supported.	MESSAGE NOT SUPPORTED BY THIS ATC UNIT	M	N

<i>Message element identifier</i>	<i>Message element intended use</i>	<i>Format for message element display</i>	<i>ALRT</i>	<i>RESP</i>
SYSU-4	System-generated notification that the received message is acceptable for display.	LOGICAL ACKNOWLEDGEMENT	N	N
SYSU-5	System-generated message indicating that requests for logical acknowledgements are not permitted.	USE OF LOGICAL ACKNOWLEDGEMENT PROHIBITED	M	N
SYSU-6	Advisory providing the maximum one-way uplink message transmission delay.	LATENCY TIME VALUE (<i>latency value</i>)	N	N
SYSU-7	Indication that the received message has a latency greater than the requirement.	MESSAGE RECEIVED TOO LATE, RESEND MESSAGE OR CONTACT BY VOICE	M	N

Table A5-13-2. System management downlinks (SYSD)

Messages dedicated to the management of the CPDLC communications (usually sent by aircraft system).

<i>Message element identifier</i>	<i>Message element intended use</i>	<i>Format for message element display</i>	<i>ALRT</i>	<i>RESP</i>
SYSD-1	System-generated notification of an error.	ERROR (<i>error information</i>)	N	N
SYSD-2	System-generated notification that the received message is acceptable for display.	LOGICAL ACKNOWLEDGEMENT	N	N
SYSD-3	System-generated rejection of any CPDLC message sent from a ground facility that is not the current data authority.	NOT CURRENT DATA AUTHORITY	M	N
SYSD-4	System-generated notification that the ground facility is now the current data authority.	CURRENT DATA AUTHORITY	M	N
SYSD-5	System-generated notification that the ground system is not designated as the next data authority (NDA), indicating the identity of the current data authority (CDA). Identity of the NDA, if any, is also reported.	NOT AUTHORIZED NEXT DATA AUTHORITY (<i>facility designation</i>) (<i>facility designation[O]</i>)	M	N
SYSD-6	Indication that the received message has a latency greater than the requirement.	MESSAGE RECEIVED TOO LATE, RESEND MESSAGE OR CONTACT BY VOICE	M	N

<i>Message element identifier</i>	<i>Message element intended use</i>	<i>Format for message element display</i>	<i>ALRT</i>	<i>RESP</i>
SYSD-7	System-generated notification that the aircraft is in the inhibited state.	AIRCRAFT CPDLC INHIBITED	M	N

14. Message elements parameters

Table A5-14-1. Parameters

Provides descriptions for the variables used in the parameters specified in the message elements.

<i>Variable</i>	<i>Description</i>
<i>aircraft identification</i>	Provides the aircraft identification identical to, or the code equivalent of, the aircraft call sign as provided in Item 7 of the flight plan.
<i>aircraft type</i>	Specifies the aircraft type when known.
<i>altimeter setting</i>	Specifies an altimeter in inches of mercury or hectopascals.
<i>arrival approach data</i>	Specifies at least one of the following: destination airport, arrival runway, arrival procedure, or approach procedure.
<i>ATIS code</i>	Specifies the current ATIS code.
<i>ATS route designator</i>	Specifies the 2-7 character name of the route.
<i>along track waypoint</i>	Specifies point in the route specified as relative distance for another waypoint on the route. May include speed and level constraints at this point.
<i>clearance limit</i>	Specifies the farthest cleared point as a <i>position</i> .
<i>clearance name</i>	Specifies a 2-14 character name of a clearance, usually specifying the name of an unpublished procedure or route.
<i>clearance type</i>	Specifies the type of clearance as: approach, departure, further, startup, pushback, taxi, or oceanic.
<i>degrees</i>	Specifies direction in terms of degrees as either degrees from magnetic north or degrees from true north.
<i>departure clearance</i>	Specifies the required departure clearance information as one or more of the following: <ul style="list-style-type: none"> • departure airport; • departure runway; • cleared to position; • departure route data specified as either; <ul style="list-style-type: none"> ○ the route is as filed; or ○ a SID and optionally that the rest of the route after the SID is as filed (i.e. then as filed). • departure level, and any constraint on the level (duration or until position); • expected level and any constraint on the level (duration or until position); • departure speed and any constraint on the speed (duration or until position); • departure heading in degrees;

<i>Variable</i>	<i>Description</i>
	<ul style="list-style-type: none"> • indication when no delay is expected; • target start-up approval time; • arrival and/or approach procedures including any special instructions; • SSR code; • ATIS code; and/or • departure frequency.
<i>departure data</i>	Specifies the departure data as at least one of the following: departure airport, departure runway, or departure procedure.
<i>deviation type</i>	Specifies the deviation type as a lateral position, level or speed.
<i>direction</i>	Specifies direction as: <ul style="list-style-type: none"> • left, right, or either side; • north, south, east, or west; or • northeast, northwest, southeast, or southwest.
<i>SSR code</i>	Specifies the SSR code as 4 octal digits.
<i>specified reason downlink</i>	Specifies the reason for the associated message as weather or aircraft performance.
<i>specified reason uplink</i>	Specifies the reason for the associated message as: opposite direction traffic, same direction traffic, converging traffic, crossing traffic, or diverging traffic, airspace restriction, invalid oceanic entry point, no flight plan held, oceanic clearance request received too late.
<i>error information</i>	Specifies reason for error as: unrecognized message reference number, insufficient resources, checksum failure, or undefined.
<i>ETP time</i>	Specifies the estimated time (hours and minutes) of passing opposite direction traffic.
<i>facility designation</i>	Specifies the ICAO location indicator for a facility.
<i>facility function</i>	Specifies the function of the facility as: centre, approach, tower, final, ground control, clearance delivery, departure, control, radio, apron, information, ramp, flight watch, AOC/company, de-icing, or flight service.
<i>free text</i>	Provides additional information in a non-structured format.
<i>frequency</i>	Specifies the frequency as an HF, VHF, or UHF frequency, or as a SATVOICE number.
<i>hold at waypoint</i>	Specifies a holding instruction providing the position of the holding as: <i>position</i> , and additionally any or all of the following: holding speed low, waypoint level constraint, holding speed high, a left or right holding, degrees, time a further clearance is expected, and <i>leg type</i> .
<i>latency value</i>	Provides the CPDLC message latency value in seconds.
<i>lateral deviation</i>	Specifies the lateral deviation as the permitted distance left, right, or either side from the cleared route in nautical miles or kilometres.
<i>latitude longitude</i>	Specifies the latitude and longitude in degrees, minutes, tenths of minutes and direction (north, south, east or west).
<i>leg type</i>	Specifies a holding leg as distance (tenths of nautical miles or tenths of kilometres) or time (tenths of minutes).

<i>Variable</i>	<i>Description</i>
<i>level</i>	Specifies a level as a single or block level in feet, metres, or flight levels.
<i>level single</i>	Specifies a single level in feet, metres, or flight levels.
<i>named instruction</i>	Specifies a named instruction as either a <i>clearance name</i> or a <i>procedure name</i> .
<i>number of degrees</i>	Provides the number of degrees.
<i>number of minutes</i>	Provides the number of minutes (time).
<i>persons on board</i>	Provides the number of persons on board or indicates that the number is unknown.
<i>place bearing distance</i>	Specifies a <i>place bearing</i> and a distance in nautical miles or kilometres.
<i>place bearing</i>	Specifies a <i>published identifier</i> and <i>degrees</i> .
<i>position</i>	Specifies a position as a: <ul style="list-style-type: none"> • <i>published identifier</i>; • <i>latitude longitude</i>; or • <i>place bearing distance</i>.
<i>Position report</i>	Provides information similar to a voice position report as defined in 4.11.2.
<i>procedure name</i>	Specifies a procedure name by specifying a procedure type (departure, arrival, or approach) and identifier (1-20 characters), and when applicable: <ul style="list-style-type: none"> • the runway; • any required procedure transition; and/or • any required additional information about the procedure.
<i>published identifier</i>	Specifies the published identifier name (1-5 characters) and associated latitude and longitude (degrees, minutes, seconds).
<i>relay text</i>	Specifies the information to be relayed to the specified aircraft as <i>free text</i> .
<i>relayed text response</i>	Specifies information relayed from the specified aircraft as <i>free text</i> .
<i>remaining fuel</i>	Specifies remaining fuel as time in seconds.
<i>revision reason</i>	Specifies the reason(s) for the clearance revision as any or all of the following: a level change, a speed change, a route change at a specified position, a route change at multiple waypoints, an entry point change, a clearance limit change, a named instruction change, and/or a ground location change.
<i>en-route data</i>	Specifies the cleared route of flight for up to 128 waypoints with positional information (<i>route information</i>), including for each waypoint as required, level constraint, speed constraint, required time of arrival, holding instruction and fly-by or flyover information (<i>route information additional</i>). A <i>clearance limit</i> may be included. A locally defined <i>named instruction</i> may also be included.
<i>route information additional</i>	Specifies any or all of the following: <ul style="list-style-type: none"> • 1 to 8 <i>along track waypoint</i>; • 1 to 8 <i>hold at waypoint</i>; • 1 to 32 <i>waypoint speed level</i>; and • 1 to 32 <i>required time arrival</i>.

<i>Variable</i>	<i>Description</i>
<i>route information</i>	Specifies route information as one of: <ul style="list-style-type: none"> • <i>published identifier</i>; • <i>latitude longitude</i>; • <i>place bearing distance</i>; or • <i>ATS route designator</i>.
<i>required time arrival</i>	For the specified position, provides the required time of arrival (hours, minutes (seconds (optional))), optionally any tolerance around the required time of arrival, and indicates the required time of arrival as at, before, or after the specified time.
<i>runway</i>	Specifies a runway by direction and configuration (left, right, centre, or none).
<i>specified deviation</i>	Specifies the deviation from the route as a <i>specified distance</i> or <i>number of degrees</i> .
<i>specified distance</i>	Specifies distance in nautical miles or kilometres.
<i>speed</i>	Specifies speed in English or metric units as: indicated, true, ground, or Mach speed.
<i>speed types</i>	Specifies the speed as a minimum or maximum and 1 to 2 speed type(s), where the speed type indicates speed as: indicated, true, ground, Mach, approach, cruise, or present.
<i>time</i>	Specifies time in hours and minutes.
<i>traffic description</i>	Specifies a description of traffic significant to a flight by providing any or all of the following information: the <i>aircraft flight identification</i> , the <i>aircraft type</i> , the current flight level of the aircraft, the location relative to the given aircraft as the distance (if known) above or below, and indicates when known that the traffic is, opposite direction, same direction, converging, crossing, or diverging from the given aircraft.
<i>traffic location</i>	Specifies the location for opposite direction traffic indicating if the traffic is above or below the given aircraft, and when known, provides the vertical distance in feet or metres.
<i>traffic visibility</i>	Indicates the traffic visibility as: sighted and passed, sighted, or not sighted.
<i>unit name</i>	Specifies the unit name by providing any or all of the following: <i>facility name</i> , <i>facility designation</i> , or <i>facility function</i> , as appropriate.
<i>vertical rate</i>	Specifies the vertical rate as feet/minute or metres/minute.
<i>waypoint speed level</i>	Specifies the speed and level constraints on the specified position.

Appendix 6

ATS INTERFACILITY DATA COMMUNICATIONS (AIDC) MESSAGES

1. INTRODUCTION

1.1 General

1.1.1 This Appendix describes the types of messages and their contents to be used for operational communications between ATS unit computer systems. This type of data transfer is referred to as ATS interfacility data communications (AIDC) and is to be the basis for migration of data communications to the aeronautical telecommunication network (ATN).

1.1.2 It is not the intention that controllers see the messages, but their operational content is required to be displayed or made available to the controllers in accordance with the display capability and procedures at the unit concerned. While the majority of flight data is provided by the system, it is a prerequisite that certain items of operational data required to be transferred can be entered at the controller working position.

1.1.3 AIDC messages contain items of data referred to as data fields. In most cases a data field is used in more than one message. A table including the AIDC data fields is included in this Appendix. Specific details on the definition, range and resolution of the fields can be found in the *Manual of Air Traffic Services Data Link Applications* (Doc 9694).

1.2 Coordination environments

1.2.1 ATC procedures vary significantly, depending on the surveillance capabilities of the coordinating ATS units in a given boundary environment. For the purpose of this Appendix the coordination environments are identified as either surveillance or procedural. In some instances the same type of message may require the inclusion of different or additional data to accommodate the demands of differing environments. Depending on the environment, the timing of the transmission of these messages may also vary. The environment may also affect whether the AIDC message is automatically processed, or displayed to the controller for manual processing.

1.2.2 A surveillance environment is an environment where an ATS surveillance system is in use, and allows controllers to positively identify the traffic. Radar and/or ADS-B are available to the controllers at sector positions on both sides of a common boundary, and traffic is identified by information presented on a situation display. Such facilities permit surveillance coordination procedures to be used.

1.2.3 A procedural environment exists in those areas where surveillance coordination procedures are not available because at least one of the coordinating ATS units does not have a surveillance capability, or the surveillance capabilities differ. For example, surveillance in oceanic and remote areas is often achieved with ADS-C, CPDLC or voice position reports; in such areas, coordination procedures differ from those used in a surveillance environment.

1.3 Message composition

1.3.1 In order to correctly link a response to an AIDC message with the original message, a reference to the original message is included in the response. The following AIDC messages shall contain a reference to the AIDC message(s) being responded to:

Operational responses such as:

Coordinate Accept;
Coordinate Reject;
Coordinate Negotiate;
Transfer Conditions Accept;
Transfer Control Assume;
Coordinate Standby.

Application management messages such as:

Application Accept;
Application Reject.

1.3.2 An AIDC message is composed of a message header and a sequence of fields of data. Each message shall contain all the mandatory fields and all relevant optional fields.

1.3.3 The message header contains a message identification, a time stamp (yyyymmddhhmmss) and a message sequence number.

2. MESSAGE PURPOSE AND USAGE

NOTIFICATION MESSAGE

2.1 Notify

The Notify message satisfies the following operational requirements:

- a) updates the basic flight plan data in the receiving ATS unit with the most recent information or allows the creation of a flight plan if one did not previously exist;
- b) provides advance information and revisions thereto from an ATS unit on a flight that is expected subsequently to enter the area of interest of another ATS unit;
- c) facilitates early correlation of ATS surveillance system tracks; and
- d) facilitates short-term sector load assessment.

COORDINATION MESSAGES

2.2 Coordinate Initial

The Coordinate Initial message satisfies the following operational requirements:

- a) replaces the verbal boundary estimate;
- b) updates the basic flight plan data in the receiving unit with the most recent information or allows the creation of a flight plan if one did not previously exist;
- c) coordinates a flight before departure in order to comply with the approval request procedure;
- d) initiates a coordination dialogue between units;
- e) facilitates distribution and display of flight plan data within the receiving unit; and
- f) expedites display of SSR code/call sign correlated data blocks in the receiving unit.

2.3 Coordinate Negotiate

The Coordinate Negotiate message satisfies the following operational requirements:

- a) forwards a counterproposal from the controller in the receiving unit to the controller in the transferring unit as a reply to a Coordinate Initial message;
- b) forwards a counterproposal to amendments proposed in a Coordinate Update or another Coordinate Negotiate message;
- c) proposes modification to previously agreed conditions if the new proposed conditions are not in accordance with the appropriate letter of agreement; and
- d) proposes an amendment to previously agreed conditions after the transfer of control has been completed (i.e. when the flight is still within proximity to the boundary between the two units).

Note.— Previously agreed conditions may include flight plan data not related to trajectory information (e.g. SSR code, CNS equipment).

2.4 Coordinate Accept

The Coordinate Accept message is used to indicate acceptance of the proposed coordination conditions during the AIDC coordination and negotiation phases.

2.5 Coordinate Cancel

The Coordinate Cancel message is used to indicate to the receiving ATS unit that all coordination and/or notification previously received for a flight is being cancelled.

Note.— This message is not a replacement for a flight plan cancellation (CNL) message and is not used to erase the basic flight plan data.

2.6 Coordinate Reject

The Coordinate Reject message is used to indicate that the proposed coordination, or revision thereto, is unacceptable and no counterproposal is being proposed. Any existing coordination conditions remain as previously coordinated.

2.7 Coordinate Standby

The Coordinate Standby message is used to indicate that the message has been received, the data has been referred to a controller and/or other unit and an operational response will be sent in due course.

2.8 Coordinate Update

The Coordinate Update message is used to transmit modifications to previously agreed coordination conditions, provided that they are in accordance with letters of agreement, each time the coordination conditions change.

Note.— Previously agreed conditions may include flight plan data not related to trajectory information (e.g. SSR code, CNS equipment).

TRANSFER MESSAGES

2.9 Transfer Initiate

The Transfer Initiate message satisfies the following operational requirements:

- a) informs the receiving unit of the current control environment of the flight; and
- b) alleviates the requirement for the controller in the transferring unit to verbally provide this information to the controller in the accepting unit.

2.10 Transfer Conditions Proposal

The Transfer Conditions Proposal message proposes conditions for the transfer of communication and control, as well as updated executive data, to the controller in the receiving unit.

Note.— Transfer of communication is not to be confused with transfer of control conditions contained in the letter of agreement between the ATS units concerned. It should be noted that transfer of communication and transfer of control do not necessarily occur simultaneously.

2.11 Transfer Conditions Accept

The Transfer Conditions Accept message indicates that the controller in the accepting unit has agreed to accept transfer of communication and control of the flight in response to a Transfer Conditions Proposal message.

2.12 Transfer Communication Request

The Transfer Communication Request message is an unsolicited request by the controller in the accepting unit to establish communication with the flight on the appropriate channel immediately.

2.13 Transfer Communication

The Transfer Communication message is used to indicate that the controller in the transferring unit has instructed the flight to establish communication with the controller in the accepting unit.

2.14 Transfer Communication Assume

The Transfer Communication Assume message is used to indicate that the accepting unit has established communication with the flight.

2.15 Transfer Control

The Transfer Control message is used to initiate the transfer phase, and indicate that the controller in the transferring unit wishes to transfer control responsibility of the flight to the accepting unit.

2.16 Transfer Control Assume

The Transfer Control Assume message is used to indicate that the accepting unit has accepted control responsibility of the flight from the transferring unit.

GENERAL INFORMATION

2.17 General Point

The General Point message satisfies the following operational requirements:

- a) draws the attention of a controller, who may or may not be the controller in the receiving unit, to a specified flight; and
- b) transfers basic flight plan data when the receiving unit does not hold details of the flight.

2.18 General Executive Data

The General Executive Data message is sent either by the transferring unit to the receiving unit or from the receiving unit to the transferring unit to provide updates to information relating to the control environment of a flight after the transition to the transfer state has commenced.

Note.— The coordination conditions are not modified by receipt of a General Executive Data message.

2.19 Free Text Emergency

The Free Text Emergency message is used for the exchange of free text relating to emergency conditions.

2.20 Free Text General

The Free Text General message is used for the exchange of free text relating to non-emergency conditions.

APPLICATION MANAGEMENT MESSAGES

2.21 Application Accept

The Application Accept message shall be sent by the receiving unit for each message (except for another application management message, or a message containing invalid data) that has been received, processed, found free of errors and is available for presentation to a control position.

2.22 Application Reject

The Application Reject message notifies the sender of the original message that it has been received but that an error has been detected within it. The Application Reject message includes a code that identifies the nature of the error.

3. AIDC MESSAGE CONTENT

3.1 Table A6-1 lists the mandatory and optional contents of each AIDC message.

3.2 One of the optional fields available for a number of the AIDC messages is *Other information*.

3.2.1 The ICAO flight plan may contain information in Item 18 — “Other information” — that affects the management of the flight. To amend the contents of an indicator in Item 18, the AIDC message shall contain the entire new contents of the indicator being amended (e.g. to amend “RMK/TCAS EQUIPPED” to include “NON RVSM”, the AIDC message contains “RMK/TCAS EQUIPPED NON RVSM”). Item 18 indicators that are not being amended should not be included in the AIDC message.

3.2.2 To delete the contents of an indicator in Item 18, the AIDC message shall contain the indicator followed by “/0” (e.g. “NAV/0” to indicate that there is no longer any significant navigation data).

Note.— It is not the intention that the receiving unit necessarily displays “NAV/0”, nor that this is a requirement to be included in the original filed flight plan.

Table A6-1. AIDC message content

<i>Message</i>	<i>Mandatory</i>	<i>Optional</i>
Notify	Aircraft identification Departure aerodrome Destination aerodrome Boundary estimate data	Flight rules Type of flight Number of aircraft (if more than one in the flight) Aircraft type Wake turbulence category CNS equipment Route Amended destination Code (SSR) Other information

<i>Message</i>	<i>Mandatory</i>	<i>Optional</i>
Coordinate Initial	Aircraft identification Departure aerodrome Destination aerodrome Boundary estimate data	Flight rules Type of flight Number of aircraft (if more than one in the flight) Aircraft type Wake turbulence category CNS equipment Route Amended destination Code (SSR) Other information
Coordinate Negotiate	Aircraft identification Departure aerodrome Destination aerodrome Boundary estimate data	Flight rules Type of flight Number of aircraft (if more than one in the flight) Aircraft type Wake turbulence category CNS equipment Route Amended destination Code (SSR) Other information
Coordinate Accept		Aircraft identification Departure aerodrome Destination aerodrome
Coordinate Reject		Aircraft identification Departure aerodrome Destination aerodrome
Coordinate Standby		Aircraft identification Departure aerodrome Destination aerodrome
Coordinate Cancel	Aircraft identification Departure aerodrome Destination aerodrome	Fix Reason for cancellation
Coordinate Update	Aircraft identification Departure aerodrome Destination aerodrome Boundary estimate data	Flight rules Type of flight Number of aircraft (if more than one in the flight) Aircraft type Wake turbulence category CNS equipment Route Amended destination Code (SSR) Other information

<i>Message</i>	<i>Mandatory</i>	<i>Optional</i>
Transfer Initiate	Aircraft identification Executive data (if available)	Track data
Transfer Conditions Proposal	Aircraft identification Executive data (if available)	Track data
Transfer Communication Request	Aircraft identification	Frequency
Transfer Communication	Aircraft identification	Frequency Track data Executive data and/or Release indication
Transfer Communication Assume	Aircraft identification	
Transfer Control	Aircraft identification	Departure aerodrome Destination aerodrome Executive data
Transfer Control Assume	Aircraft identification	Departure aerodrome Destination aerodrome
General Point	Aircraft identification Departure aerodrome Destination aerodrome	Sector designator (sending) Sector designator (receiving) Flight rules Type of flight Number of aircraft (if more than one in the flight) Aircraft type Wake turbulence category CNS equipment Route Track data Code (SSR) Other information
General Executive Data	Aircraft identification	Executive data Frequency
Free Text Emergency	Facility designation or Aircraft identification Free text	
Free Text General	Facility designation or Aircraft identification Free text	
Application Accept		
Application Reject	Error code	Error data

— END —

REFERENCES AND FURTHER READING

INTERNET LINKS - STATE PUBLICATIONS

- **NAT Doc 007**, edition 2017: <http://www2010.icao.int/EURNAT/Pages/EUR-and-NAT-Document.aspx>
- **Canada AIP**: <http://www.navcanada.ca/EN/products-and-services/Pages/AIP.aspx>
- **Iceland AIP**: <http://eaip.icetra.is/>
- **Ireland AIP**: <http://iaip.iaa.ie/iaip/index.htm>
- **UK AIP**: <http://www.nats.aero/do-it-online/ais/>
- **Portugal AIP**: <https://www.nav.pt/ais>
- **Canadian AIM - NAT section**: <https://www.tc.gc.ca/media/documents/ca-publications/AIM-2016-2-E-NAT.pdf>
- **FAA NAT Resource Guide**: https://www.faa.gov/about/office_org/headquarters_offices/avs/offices/afs/afs400/afs470/media/NAT.pdf

QUESTIONS AND GUIDANCE

- For more guides like this, and weekly international updates, we highly recommend you join fellow pilots, dispatchers, controllers and managers in OPSGROUP – the heart of International Flight Ops. **opsgroup.co**
- For specific planning and routing questions about the NAT, you can email **go@flightservice.org**
- NAT Plotting chart: <http://shop.fsbureau.org/online/north-atlantic-plotting-chart> (free for OpsGroup)

CORRECTIONS

- Tell us about any errors or improvements that should be made at **pubs@fsbureau.org**.

JOIN US

opsgroup2017.com

Together: Better
OPSGROUP

We are the the Pilots, Controllers, Dispatchers, Managers and Problem-solvers of International Flight Operations.
We believe that by working together, we make everyone's job easier

1,500

OPSGROUP
MEMBERS

94

COUNTRIES
WORLDWIDE

Membership is open to all flight operations professionals

Read all Reviews

Join us

Ask



OpsGroup by the numbers 2017

opsgroup2017.com

	Total	Detail
Members 2017	1610*	By function: 1. Pilots 2. Dispatchers 3. ATC 4. Managers 5. CAA 6. Military *as at January 2017
Full International Ops Bulletins 2016	52	By content: 1. Airspace changes 2. Security warnings 3. New procedures 4. Visa/Travel 5. Airport closures 6. Safety issues
Airport and ATC members reviews 2016	2287	
Slack Live Group active users	380	Channels: #todaysops, #questions, #usefuldocs, #gen
SafeAirspace countries monitored	191	
FSB Alerts, Publications, Notices 2016	172	By type: 1. Member Notices 2. Country Lowdown 3. Planning Guide 4. Unsafe Airspace Summary 5. Alerts
International Ops Questions inbound	800*	Includes MQ/Member Questions, enquiries to FSB International Desk, channel questions on slack. *approximate.
Positive reviews by members	125	opsgroup2017.com/reviews.html
Average member satisfaction	8.72	Survey January 2017, "how useful is OpsGroup?". Out of 10.
FSB Direct Support hours 2016	3,700	International Desk operator support to members (Paid service)



"It's great to have a go-to resource that responds quickly. I always get a quick answer regarding international operations."

- GOOGLE, INC
Andrew DeLa Torre, G550 Capt.



"OPSGROUP is an excellent first resource to go to when beginning ops in unfamiliar areas of the planet. Kudos!"

- FEDEX
Mike Gibson



"I love the OPSGROUP briefings via email ..."

- UNITED AIRLINES
Fergus Flanagan, Mgr Dispatch Ops



"The OPSGROUP bulletins have become one of the most important trip planning resources available before our international trips. And out of Hong Kong, every trip is an international trip!"

- GAMA AVIATION
Capt. Vince Moore



"A really great resource for international flight ops. Keep up the good work!"

- ROCKET ROUTE
Rob Randall



"OPSGROUP is a must have for any flight department conducting operations to remote/international destinations"

- BOEING
David Wilson

We can't live without the support from OPSGROUP; it will be a pinnacle part of our flight planning for years to come.

★★★★★ Kevin DeSha, Flight Dept Manager, TFT Aviation

OpsGroup has really helped us out monitoring and keeping up with all the changes in the fast and ever changing airline environment we live in today.

★★★★★ Bjorgvin H. Narfason, Manager Flight Dispatch, Air Atlanta Icelandic.